

KNX M-Bus Meters

USER MANUAL

Issue date: 11/2022 r1.2 ENGLISH



Important User Information

Disclaimer

The information in this document is for informational purposes only. Please inform HMS Industrial Networks of any inaccuracies or omissions found in this document. HMS Industrial Networks disclaims any responsibility or liability for any errors that may appear in this document.

HMS Industrial Networks reserves the right to modify its products in line with its policy of continuous product development. The information in this document shall therefore not be construed as a commitment on the part of HMS Industrial Networks and is subject to change without notice. HMS Industrial Networks makes no commitment to update or keep current the information in this document.

The data, examples and illustrations found in this document are included for illustrative purposes and are only intended to help improve understanding of the functionality and handling of the product. In view of the wide range of possible applications of the product, and because of the many variables and requirements associated with any particular implementation, HMS Industrial Networks cannot assume responsibility or liability for actual use based on the data, examples or illustrations included in this document nor for any damages incurred during installation of the product. Those responsible for the use of the product must acquire sufficient knowledge in order to ensure that the product is used correctly in their specific application and that the application meets all performance and safety requirements including any applicable laws, regulations, codes and standards. Further, HMS Industrial Networks will under no circumstances assume liability or responsibility for any problems that may arise as a result from the use of undocumented features or functional side effects found outside the documented scope of the product. The effects caused by any direct or indirect use of such aspects of the product are undefined and may include e.g. compatibility issues and stability issues.

Gateway for the integration of M-Bus devices into KNX home automation systems.

ORDER CODE	LEGACY ORDER CODE
INKNXMEB0100000	IBKNXMEB0100000
INKNXMEB0200000	IBKNXMEB0200000
INKNXMEB0600000	IBKNXMEB0600000
INKNXMEB1200000	IBKNXMEB1200000

INDEX

- 1 Description5
 - 1.1 Introduction5
 - 1.2 Functionality6
 - 1.3 Gateway's capacity7
- 2 KNX System8
 - 2.1 Description8
 - 2.2 Points definition8
- 3 Connections9
 - 3.1 Powering the device10
 - 3.2 Connection to KNX10
 - 3.3 Connection to M-Bus10
 - 3.4 Connection to the configuration tool10
- 4 Set-up process and troubleshooting11
 - 4.1 Pre-requisites11
 - 4.2 Intesis MAPS. Configuration & monitoring tool for Intesis KNX series11
 - 4.2.1 Introduction11
 - 4.2.2 Connection11
 - 4.2.3 Configuration tab12
 - 4.2.4 Signals12
 - 4.2.5 Sending the configuration to Intesis13
 - 4.2.6 Diagnostic13
 - 4.3 Set-up procedure15
- 5 Electrical & Mechanical Features16
- 6 Dimensions17

1 Description

1.1 Introduction

This document describes the integration of M-Bus meters with KNX home automation systems using the gateway Intesis KNX - M-Bus.

The aim of this integration is to make accessible M-Bus devices signals and resources from a KNX network, as if it was a part of the own KNX system and vice-versa. To do it so, Intesis performs as a one more KNX device, sending and receiving telegrams to group addresses in the KNX network.

Intesis incorporates and embeds M-Bus level converter, so no extra hardware is required.

Configuration is carried out using the configuration software Intesis™ MAPS.

This document assumes that the user is familiar with KNX and M-Bus technologies and their technical terms.

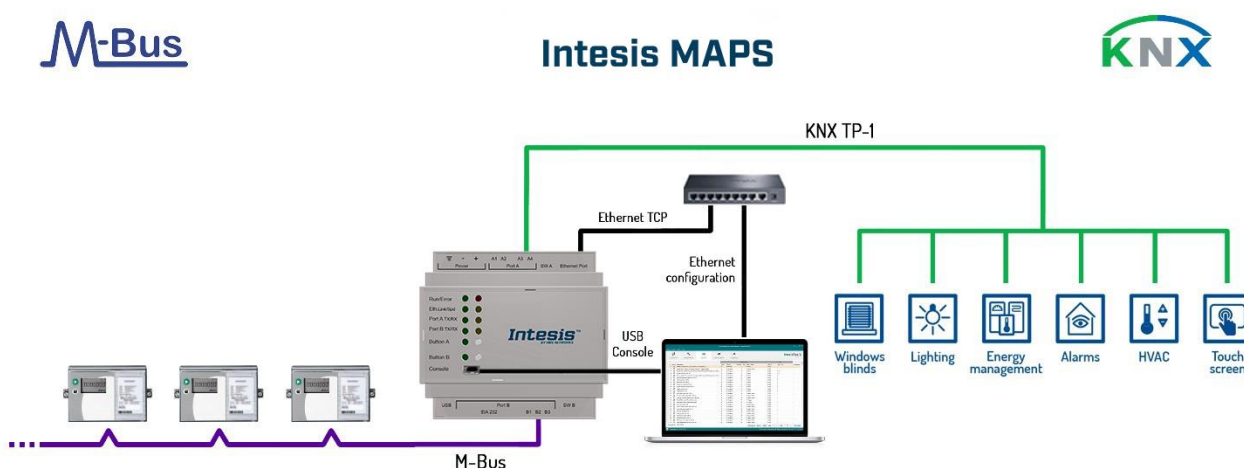

Integration of MBUS devices to KNX home automation systems

1.2 Functionality

Intesis polls, either continuously or only when ordered from the KNX, the M-Bus devices to obtain updated readings for the points configured in it (the points corresponding to measures and states of the meters in the integration points list explained later in this document). With every read, the new values received are updated in the Intesis's memory and become updated in the KNX side. When a change in any point configured as write-enabled in Intesis is detected (this is written from the KNX side), the corresponding action in the M-Bus device will be performed. These actions can be: force a polling of a specific M-Bus device or force a polling of all M-Bus devices.

The polling of a specific M-Bus device, or of all M-Bus devices, can be forced in any moment from KNX side by writing a 1 in the corresponding KNX object specially enabled for this purpose in the Intesis.

The automatic continuous polling of all M-Bus devices can be activated/deactivated writing from KNX in a specific KNX object specially enabled for this purpose in the Intesis.

Other M-Bus information accessible from KNX, using specific KNX objects of the Intesis, is:

- Bus activity (indicates if meters are currently being polled or if polling is in stand-by).
- M-Bus status of every meter (this M-Bus status is sent by the own meter with every poll and indicates the internal status, manufacturer specific in every case).

These are the main features of the M-Bus interface of Intesis:

- Embedded level converter. Direct connection to M-Bus devices with no extra hardware required.
- Scan option to automatically detect M-Bus devices and its available registers.
- Import/Export of M-Bus device templates.
- MBUS-/+ two wires (plug-in terminal bloc with screws) connection.
- Baud rate configurable from 300 to 9600 bps (allowed baud rates in M-Bus. The devices are normally configured at 2400 bps at the factory).
- Primary or secondary addressing allowed.
- Useful timeouts and specific parameters to make the interface widely compatible with many meter's peculiarities found usually between different manufacturers.
- Polling of the meters can be continuously, either configured in the own Intesis or you can activate/deactivate continuous polling of the meters from KNX side using a special datapoint.
- You can force a polling of the meters (refresh of readings) in any moment from KNX side using special datapoints: one datapoint to force a polling of all the meters, and one specific datapoint per meter to force the polling of the individual meter.
- Intesis can also be configured to make a single polling of the meters (refresh of readings) at start up.
- For each meter, a datapoint is available in KNX indicating communication error with the meter, also a general communication error datapoint is available (that will be active whenever the communication with one or more meters has failed).
- Fully flexible configuration of the registers to poll in the meter, to adapt to any meter.

Every meter, depending on manufacturer and model, offers different type of signals from the mentioned before. To know what signals offers the meter and of what type, to be able to integrate those wanted, refer to the device technical documentation. Anyway, and to ease and speed up the identification of the signals offered by any device (and of what type), the scan option is highly recommended or the import of templates too.

1.3 Gateway's capacity

Intesis capacity is listed below:

Element	10 version	20 version	60 version	120 version	Notes
Type of KNX devices	KNX TP-1				Communication with KNX TP-1 networks.
Number of KNX Objects	250	500	1500	3000	Maximum number of points that can be defined in the virtual KNX device inside the gateway.
Type of M-Bus devices	M-Bus Slave devices				Those supporting M-Bus EN-1434-3 standard.
Number of M-Bus slave devices	10	20	60	120	Number of M-Bus slave devices supported by the gateway.
Number of M-Bus signals	250	500	1500	3000	Number of M-Bus signals (readings in the meters) that can be read from Intesis.

2 KNX System

In this section, a common description for all Intesis KNX series gateways is given, from the point of view of KNX system which is called from now on *internal system*. Connection with the MBUS system is also called from now on *external system*.

2.1 Description

Intesis KNX connects directly to the KNX TP-1 bus and performs as one more device into the KNX system, with the same configuration and operational characteristics as other KNX devices.

Internally, the circuit part connected to the KNX bus is opto-isolated from the rest of the electronics.

Intesis KNX receives, manages and sends all the telegrams related to its configuration to the KNX bus.

When a change in a signal of the external system is detected, a WRITE telegram is sent to the KNX bus (addressed with the group address associated to the corresponding group object), in order to maintain both systems synchronised in every moment.

The status of the KNX bus is checked continuously and, if a bus drop-down is detected, for example due to failure in the bus power supply, after the KNX bus is restored again, Intesis will send READ telegrams to group addresses of all communication objects marked with flag 'Ri'. The behaviour of each individual point into Intesis is determined by the flags configured for the communication object. See details below.

2.2 Points definition

Every KNX object in configuration has following KNX properties:

Property	Description
Description	Descriptive information about the communication object or signal.
Object function	Information on range of values for the group object.
DPT	Datapoint type. It is the KNX data type used to encode the signal's value. It will depend on the type of signal associated in the external system in every case.
Group	It is the KNX group to which the point is associated. It is also the group to which the read (R), write (W), transmit (T), update (U) and read on init (Ri) flags are applied. It is the sending group.
Listening addresses	They are the addresses that can write on the group object, apart of the main group address.
R	Read. If this flag is activated, READ telegrams of this group address will be accepted.
Ri	Read on Init. If this flag is activated, the object will trigger corresponding READ request (on associated group address) on initialization.
W	Write. If this flag is activated, WRITE telegrams on this group object will be accepted.
T	Transmit. If this flag is activated, when the group object value changes, due to a change in the external system, a WRITE telegram of the associated group address will be sent to the KNX bus.
U	Update. If this flag is activated, UPDATE telegrams (response to READ telegrams) on this group object will be accepted.
Active	If activated, the point will be active in Intesis, if not, the behaviour will be as if the point is not defined. This allows deactivating points without the need of delete them for possible future use.

These properties are common for all Intesis KNX series gateways. Although each integration may have specific properties according to the type of signals of the external system.

3 Connections

Find below information regarding the Intesis connections available.

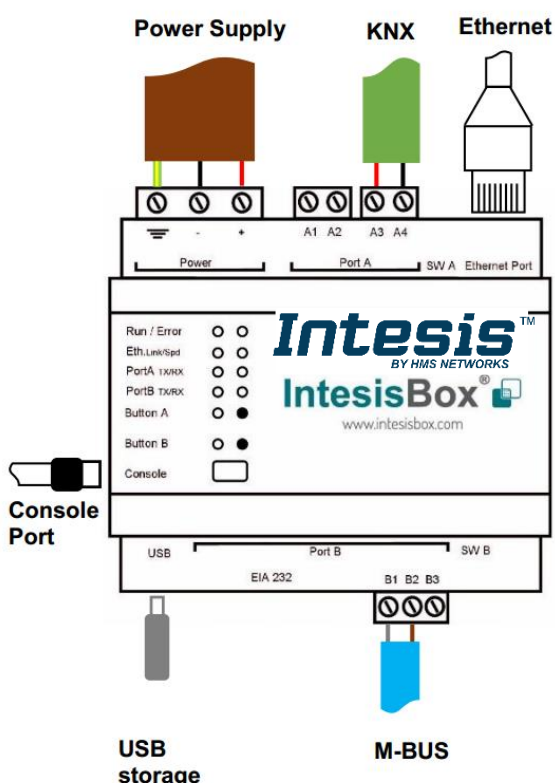

Power Supply

Must use NEC Class 2 or Limited Power Source (LPS) and SELV rated DC power supply.

Respect polarity applied of terminals (+) and (-). Be sure the voltage applied is within the range admitted (check table below). The power supply must be connected to earth.

Ethernet / Console (UDP & TCP)

Connect the cable coming from the IP network to the connector ETH of the gateway. Use an Ethernet CAT5 cable. If communicating through the LAN of the building, contact the network administrator and make sure traffic on the port used is allowed through all the LAN path (check the gateway user manual for more information). Default IP is 192.168.100.246. DHCP is enabled by default.

PortA / KNX

Connect the KNX TP-1 bus to connectors A3 (+), A4 (-) of gateway's PortA. Respect the polarity.

PortB / M-Bus

Connect the MBUS to connectors B1 (M-), B2 (M+) of gateway's PortB. Respect the polarity.

Console Port

Connect a mini-type B USB cable from your computer to the gateway to allow communication between the Configuration Software and the gateway. Remember that Ethernet connection is also allowed. Check the user manual for more information.

USB

Connect a USB storage device (not a HDD) if required. Check the user manual for more information.

Ensure proper space for all connectors when mounted (see section 6).

3.1 Powering the device

A power supply working with any of the voltage range allowed is needed (check section 5). Once connected the RUN led (Figure above) will turn on.

WARNING! In order to avoid earth loops that can damage the gateway and/or any other equipment connected to it, **is mandatory to use DC power supplies connected to earth.**

3.2 Connection to KNX

Connect the KNX TP1 bus to connectors A3 (+) and A4 (-) of gateway's PortA. Respect the polarity.

3.3 Connection to M-Bus

The gateway connects to the M-Bus system directly without requiring any external RS232 or RS485 to M-Bus level converter.

Connect the M-Bus bus to connectors B1 (M-) and A2 (M+) of gateway's PortB.

Remember that the Intesis provides 36VDC M-Bus voltage to the bus, acting as a M-Bus level converter as well.

In case there is no response from the M-Bus device(s) to the frames sent by Intesis, check that they are operative and reachable from the network connection used by Intesis. You can use an EIA-485-to-USB converter and a M-Bus Master software (such as MBSheet or similar) to double check the M-Bus installation.

3.4 Connection to the configuration tool

This action allows the user to have access to configuration and monitoring of the device (more information can be found in the configuration tool User Manual). Two methods to connect to the PC can be used:

- **Ethernet:** Using the Ethernet port of Intesis.
- **USB:** Using the console port of Intesis, connect a USB cable from the console port to the PC.

4 Set-up process and troubleshooting

4.1 Pre-requisites

It is necessary to have a KNX network operative and well connected to the corresponding KNX port of Intesis and a M-BUS device (or network of M-BUS devices) connected at its corresponding port as well.

Connectors, connection cables, PC to use the configuration tool and other auxiliary material, if needed, are not supplied by HMS Industrial Networks S.L.U for this standard integration.

Items supplied by HMS Networks for this integration are:

- Intesis gateway.
- Link to download the configuration tool.
- Product documentation.

4.2 Intesis MAPS. Configuration & monitoring tool for Intesis KNX series

4.2.1 Introduction

Intesis MAPS is a Windows® compatible software developed specifically to monitor and configure Intesis KNX series.

The installation procedure and main functions are explained in the *Intesis MAPS User Manual for KNX*. This document can be downloaded from the link indicated in the installation sheet supplied with the Intesis device or in the product website at www.intesis.com

In this section, only the specific case of KNX to M-BUS systems will be covered.

Please check the Intesis MAPS user manual for specific information about the different parameters and how to configure them.

4.2.2 Connection

To configure the Intesis connection parameters press on the **Connection** button in the *menu bar*.

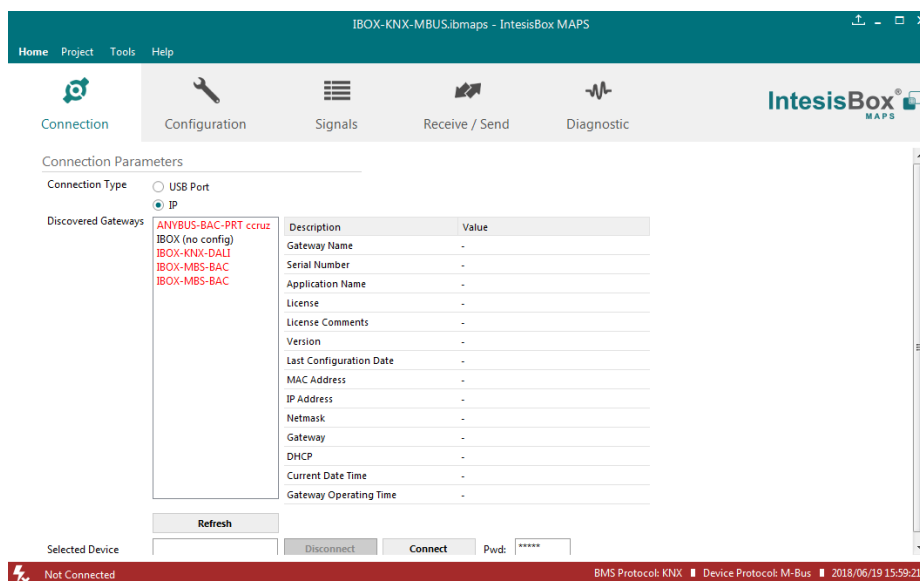

Figure 4.1 MAPS connection

4.2.3 Configuration tab

Select the **Configuration** tab to configure the connection parameters. Three subsets of information are shown in this window: General (Gateway general parameters), KNX Server (KNX interface configuration) and M-Bus (M-Bus configuration parameters).

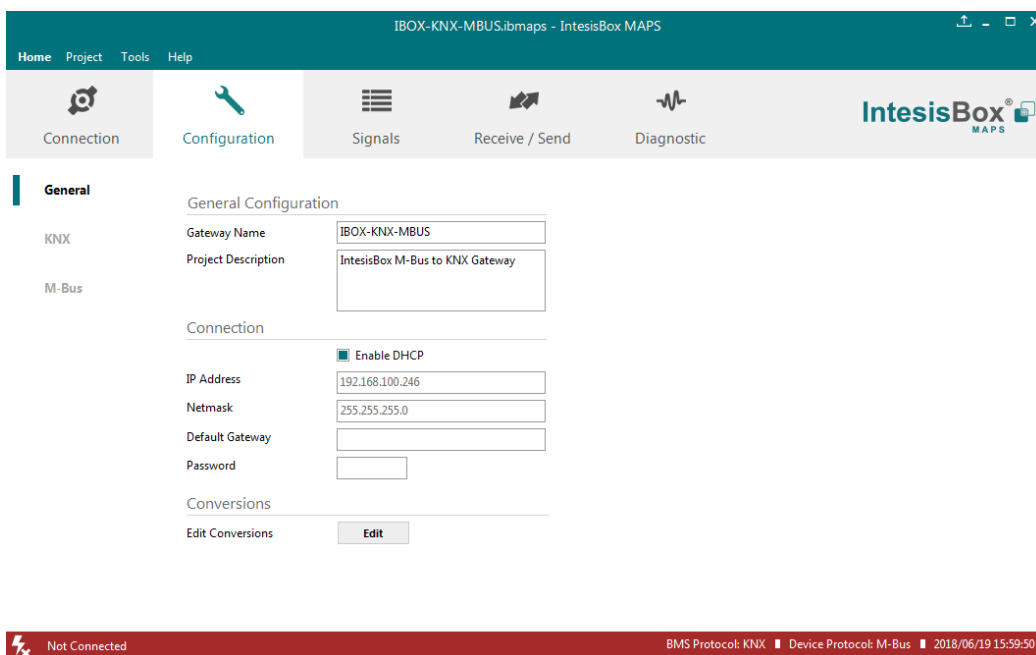

Figure 4.2 Intesis MAPS configuration tab

4.2.4 Signals

All available objects, KNX objects, its corresponding M-Bus register and other main parameters are listed in the signals tab. More information on each parameter and how to configure it can be found in the Intesis MAPS user manual.

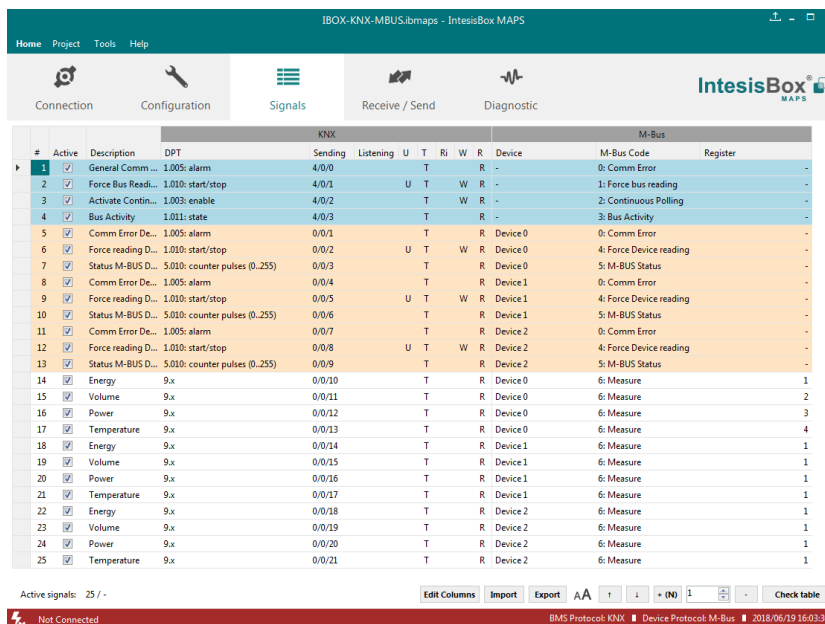

Figure 4.3 Intesis MAPS Signals tab

4.2.5 Sending the configuration to Intesis

When the configuration is finished, follow the next steps.

1.- Save the project (Menu option **Project->Save**) on your hard disk (more information in Intesis MAPS User Manual).

2.- Go to tab '**Receive / Send**' of MAPS, and in **Send** section, press **Send** button. Intesis will reboot automatically once the new configuration is loaded.

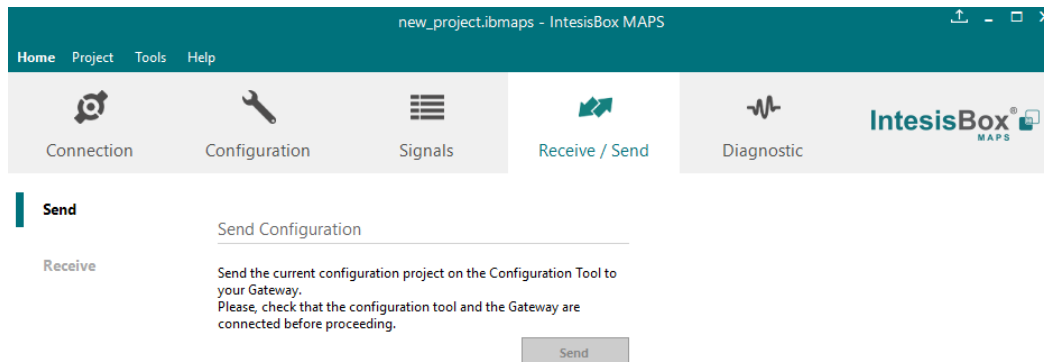

Figure 4.4 Intesis MAPS Receive/Send tab

After any configuration change, do not forget to send the configuration file to the Intesis using button Send File.

4.2.6 Diagnostic

To help integrators in the commissioning tasks and troubleshooting, the Configuration Tool offers some specific tools and viewers.

In order to start using the diagnostic tools, connection with the Gateway is required.

The Diagnostic section is composed by two main parts: Tools and Viewers.

- **Tools**
Use the tools section to check the current hardware status of the box, log communications into compressed files to be sent to the support, change the Diagnostic panels' view or send commands to the gateway.
- **Viewers**
In order to check the current status, viewer for the Internal and External protocols are available. It is also available a generic Console viewer for general information about communications and the gateway status and finally a Signals Viewer to simulate the BMS behavior or to check the current values in the system.

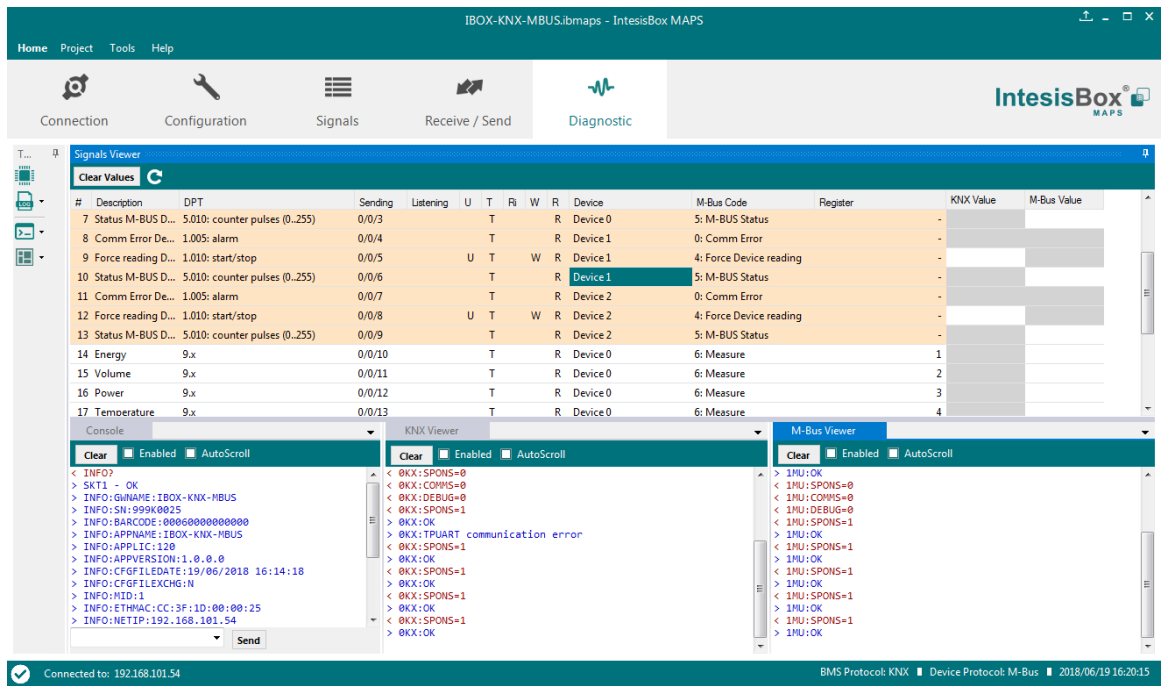

Figure 4.5 Diagnostic

More information about the Diagnostic section can be found in the Configuration Tool manual.

4.3 Set-up procedure

1. Install Intesis MAPS on your laptop, use the setup program supplied for this and follow the instructions given by the Installation wizard.
2. Install Intesis in the desired installation site. Installation can be on DIN rail or on a stable not vibrating surface (DIN rail mounted inside a metallic industrial cabinet connected to ground is recommended).
3. Connect the KNX communication cable coming from the KNX network to the port marked as Port A on Intesis (More details in section 3).
4. Connect the M-Bus communication cable coming from the M-Bus network to the port marked as Port A on Intesis (More details in section 3).
5. Power up Intesis. The supply voltage should be 24Vdc. Take care of the polarity of the supply voltage applied.

WARNING! In order to avoid earth loops that can damage Intesis and/or any other equipment connected to it, **is mandatory to use DC power supplies connected to earth.**

6. If you want to connect using IP, connect the Ethernet cable from the laptop PC to the port marked as Ethernet of Intesis (More details in section 3).

If you want to connect using USB, connect the USB cable from the laptop PC to the port marked as Console of Intesis (More details in section 3).

7. Open Intesis MAPS, create a new project selecting a copy of the one named **INKNXMEB---0000**.
8. Modify the configuration as desired, save it and download the configuration file to Intesis as explained in the Intesis MAPS user manual.
9. Visit the Diagnostic section and check that there is communication activity, some TX frames and some other RX frames. This means that the communication with the KNX device and M-Bus devices is OK. In case there is no communication activity between Intesis and the KNX and/or M-Bus devices, check that those are operative: check the baud rate, the communication cable used to connect all devices and any other communication parameter.

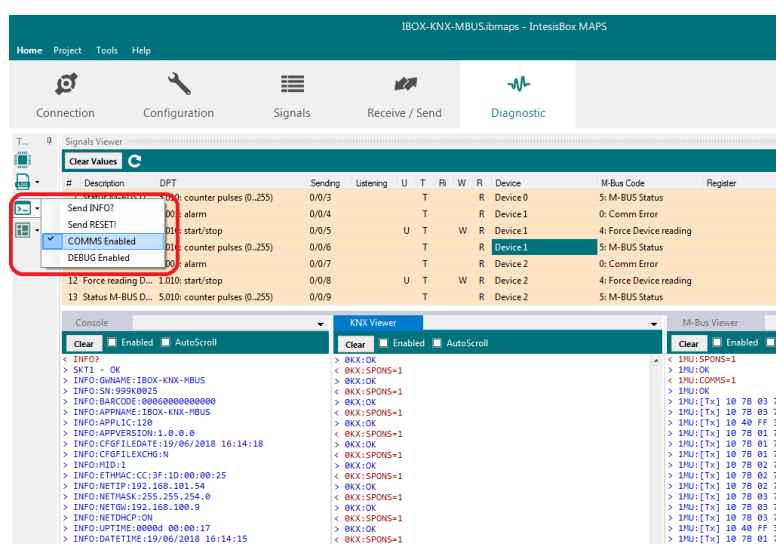

Figure 4.6 Enable COMMS

5 Electrical & Mechanical Features



Enclosure	Plastic, type PC (UL 94 V-0) Net dimensions (dwxh): 90x88x56 mm Recommended space for installation (dwxh): 130x100x100mm Color: Light Grey. RAL 7035	Battery	Size: Coin 20mm x 3.2mm Capacity: 3V / 225mAh Type: Manganese Dioxide Lithium
Mounting	Wall. DIN rail EN60715 TH35.	Console Port	Mini Type-B USB 2.0 compliant 1500VDC isolation
Terminal Wiring (for power supply and low-voltage signals)	Per terminal: solid wires or stranded wires (twisted or with ferrule) 1 core: 0.5mm ² ... 2.5mm ² 2 cores: 0.5mm ² ... 1.5mm ² 3 cores: not permitted If cables are more than 3.05 meters long, Class 2 cable is required.	USB port	Type-A USB 2.0 compliant Only for USB flash storage device (<i>USB pen drive</i>) Power consumption limited to 150mA (<i>HDD connection not allowed</i>)
Power	1 x Plug-in screw terminal block (3 poles) Positive, Negative, Earth 24VDC	Push Button	Button A: KNX programming button (not used) Button B: Not used
Ethernet	1 x Ethernet 10/100 Mbps RJ45 2 x Ethernet LED: port link and activity	Operation Temperature	0°C to +60°C
Port A	1 x KNX TP-1 Plug-in screw terminal block orange (2 poles) 2500VDC isolation from other ports KNX power consumption: 5mA Voltage rating: 29VDC 1 x Plug-in screw terminal block green (2 poles) Reserved for future use	Operational Humidity	5 to 95%, no condensation
Switch A (SWA)	1 x DIP-Switch for PORT A configuration: Reserved for future use	Protection	IP20 (IEC60529)
PORT B	1 x Serial EIA232 (SUB-D9 male connector) Reserved for future use 1 x M-BUS Plug-in screw terminal block (3 poles) MBUS power consumption: 210mA Voltage rating: 36VDC (except PORT B: EIA232)	LED Indicators	10 x On board LED indicators 1 x Error LED 1 x Power LED 2 x Ethernet Link/Speed 2 x Port A TX/RX 2 x Port B TX/RX 1 x Button A indicator 1 x Button B indicator
Switch B (SWB)	1 x DIP-Switch for PORT B configuration: Reserved for future use		

6 Dimensions

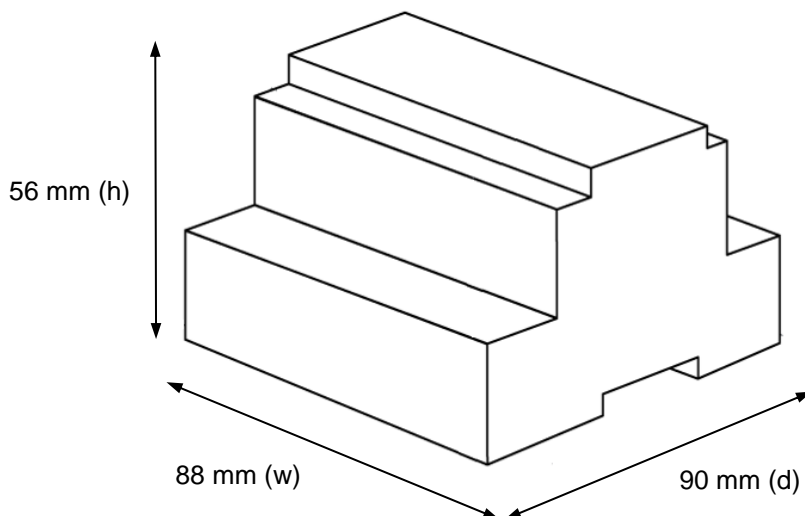

Recommended available space for its installation into a cabinet (wall or DIN rail mounting), with space enough for external connections

