

Brief Instruction Mounting of WS1000 Color

Item numbers 60121-60128 (WS1000 Color)



The manual with additional information about commissioning, functions and use of the controls **WS1000 Color** can be downloaded from www.elsner-elektronik.de in the menu area "Service/Downloads".



Warning, mains voltage! National legal regulations are to be observed. Installation, inspection, commissioning and troubleshooting of the device must only be carried out by a competent electrician.

Notes on wireless equipment

When planning facilities with devices that communicate via radio, adequate radio reception must be guaranteed. The range will be limited by legal regulation and structural circumstances. Avoid sources of interference and obstacles between receiver and transmitter, that could disturb the wireless communication. Those would be for example:

- Walls and ceilings (especially concrete and solar protection glazing).
- Metal surfaces next to the wireless participants (e. g. aluminium construction of a conservatory).
- Other wireless devices and powerful local transmitters (e.g. wireless headphones), which transmit on the same frequency. Please maintain a minimum distance of 30 cm between wireless transmitters for that reason.

Preparing the installation location



The device must only be installed and used in dry, interior spaces. Avoid condensation.

Cut-out dimensions for concealed box (approx.): W=229 mm | H=163 mm | D=62 mm:

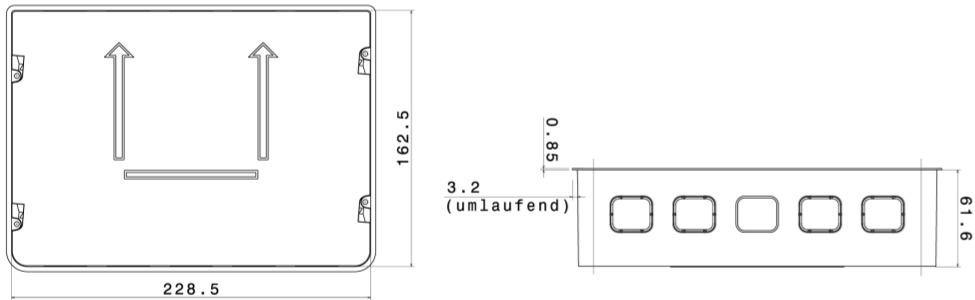

An external antenna can be connected in order to improve wireless communications. During installation, a **conduit 50 cm in length** should be placed beneath the recessed housing, in which the external antenna can be mounted (antenna dimensions approx. 565 x 8 x 5, L x W x H in mm):

Conduit angled diagonally downwards (for cable access from above or below)

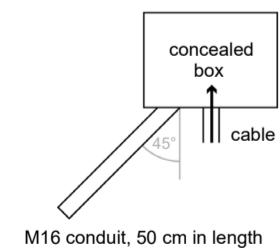

Conduit angled vertically downwards (only for cable access from above!)

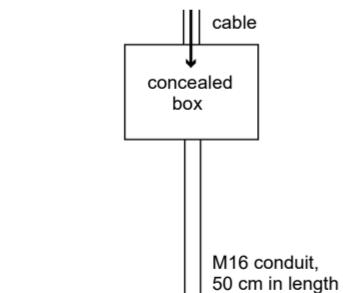

Preparing for installation

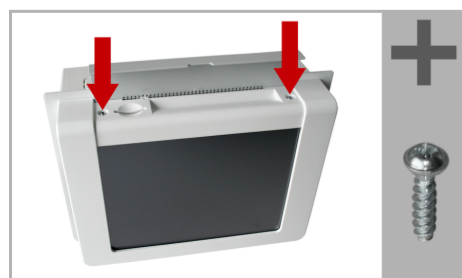

To take off the front plate, remove the screws beneath the lid.

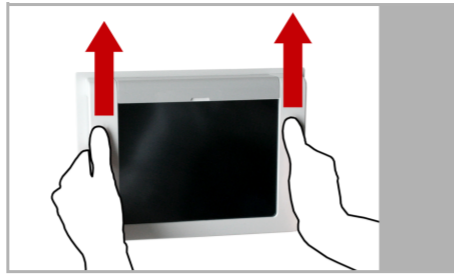

Push the upper section of the housing (frame with display) up a little and lift it off.

Caution: The display is connected with a flat-ribbon cable to the circuit board in the concealed box. Loosen the plug so that the upper section can be removed.

The lid cover is only attached by a hinge. Take care not to lose it.

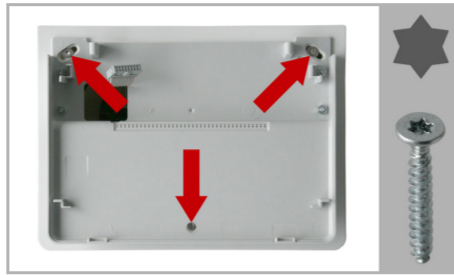

The lower section of the housing together with the wall-mounting plate is attached to the concealed box with 3 screws: Loosen the screws and take off the lower part.

Wall-fitting

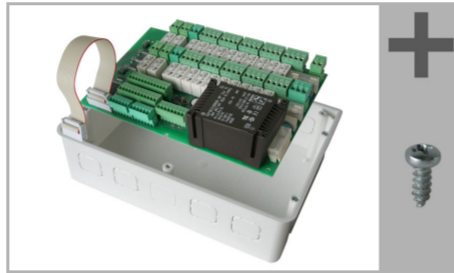

Remove the circuit board from the concealed box to be installed a keep it in a place where it is protected from dirt. **It may never be exposed to dust or moisture!**

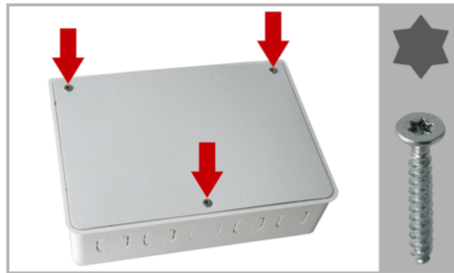

For fitting, screw the cover (board) on to the concealed box with the enclosed screws.

Cavity wall fitting



Clamp the concealed box to the wall with the four enclosed screws.

Upon delivery, the pouch containing the assembly screws can be found in the control unit's flush-mounted casing.

Assembling the control unit with concealed box

During electrical installation, please introduce all connection cables into the concealed box through the lower or upper side wall. In the process, keep the individual connection wires short to prevent long reserve loops.

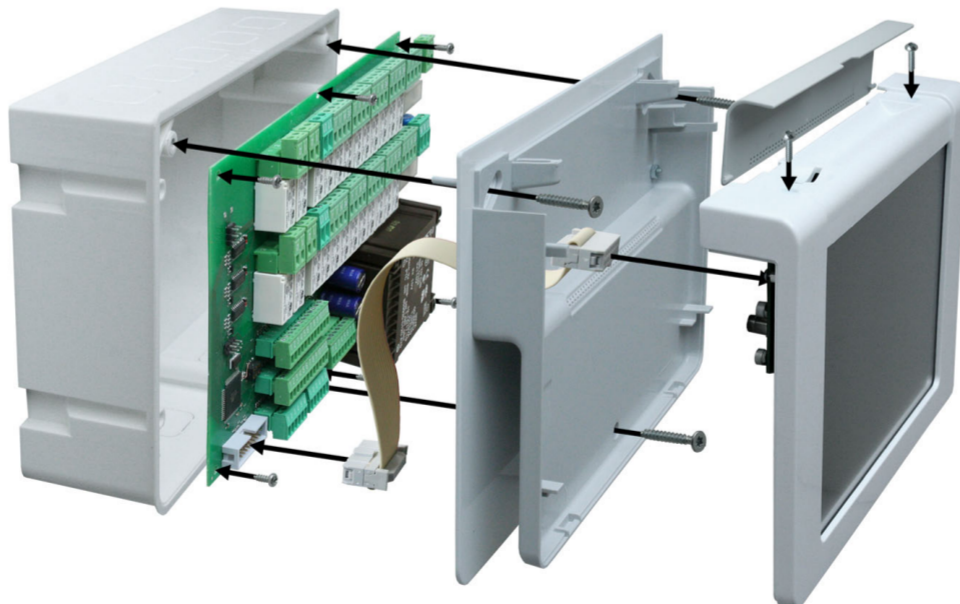

After connecting the cables screw the lower section of the housing (with the mounting plate) onto the concealed box. Connect the flat ribbon cable to the display.

Put the lid cover on the upper section of the housing (with the mounting plate). Put the upper section of the housing onto the lower section of the housing from above and move it downwards until the bottom edges are aligned. Screw on the upper section.

Structure of the connector board WS1000 Color

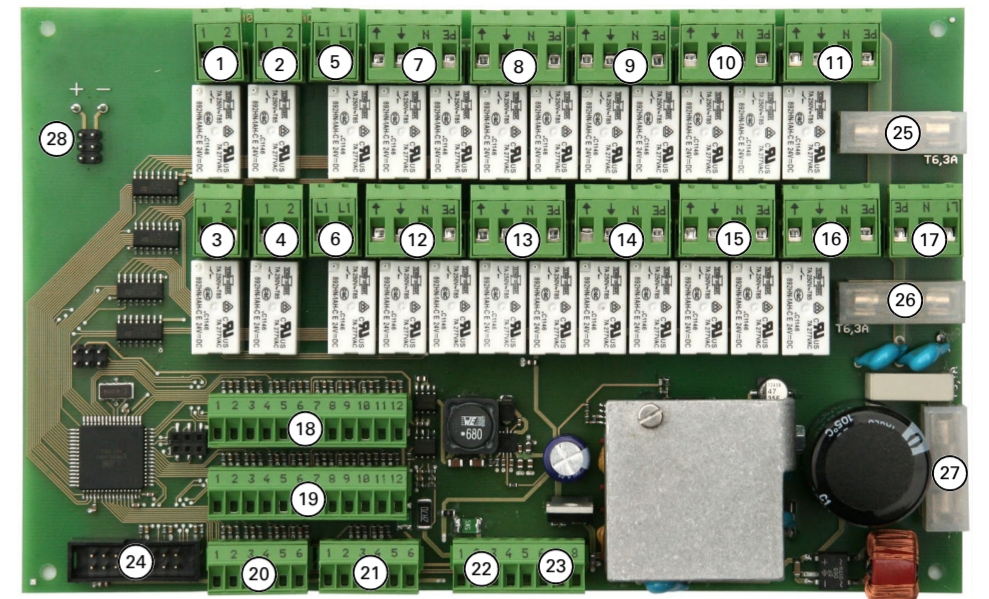

- | | |
|---|---|
| 1 Multifunctional output 1 (potential-free) | 20 Wall button 9 (terminals 1-3) |
| 2 Multifunctional output 2 (pot.-free) | Wall button 10 (terminals 4-6), |
| 3 Multifunctional output 3 (pot.-free) | 21* Multifunctional input 1 (terminals 1-3) |
| 4 Multifunctional output 4 (pot.-free) | Multifunctional input 2 (terminals 4-6) |
| 5 Outer conductor L1 | 22 Weather station (terminals 1-2) |
| 6 Outer conductor L1 | Wire assignment: red = 1, black = 2, yellow and white = not connected |
| 7 Drive group 1 | 23* Multifunctional input 3 (terminals 3-5) |
| 8 Drive group 2 | Multifunctional input 4 (terminals 6-8) |
| 9 Drive group 3 | 24 Connector for flat-ribbon cable to front board |
| 10 Drive group 4 | 25 Microfuse T6.3 A (Drive 1-5) |
| 11 Drive group 5 | 26 Microfuse T6.3 A (Drive 6-10) |
| 12 Drive group 6 | 27 Microfuse T630 mA |
| 13 Drive group 7 | 28 Slot KNX interface |
| 14 Drive group 8 | |
| 15 Drive group 9 | |
| 16 Drive group 10 | |
| 17 Mains connection L/N/PE 230 V/50 Hz | |
| 18 Wall button 1 (terminals 1-3) | |
| Wall button 2 (terminals 4-6) | |
| Wall button 3 (terminals 7-9) | |
| Wall button 4 (terminals 10-12) | |
| 19 Wall button 5 (terminals 1-3) | |
| Wall button 6 (terminals 4-6) | |
| Wall button 7 (terminals 7-9) | |
| Wall button 8 (terminals 10-12), | |
- * Supply voltage indoor sensor possible via MF inputs (No. 21, terminals 1(+), 2(-) | 4(+), 5(-) and No. 23, term. 3(+), 4(-) | 6(+), 7(-)), max. 400 mA altogether.

Connection diagram

Drive and MF outputs WS1000 Color:

per drive output max. 400 W, total max. 1.5 kW

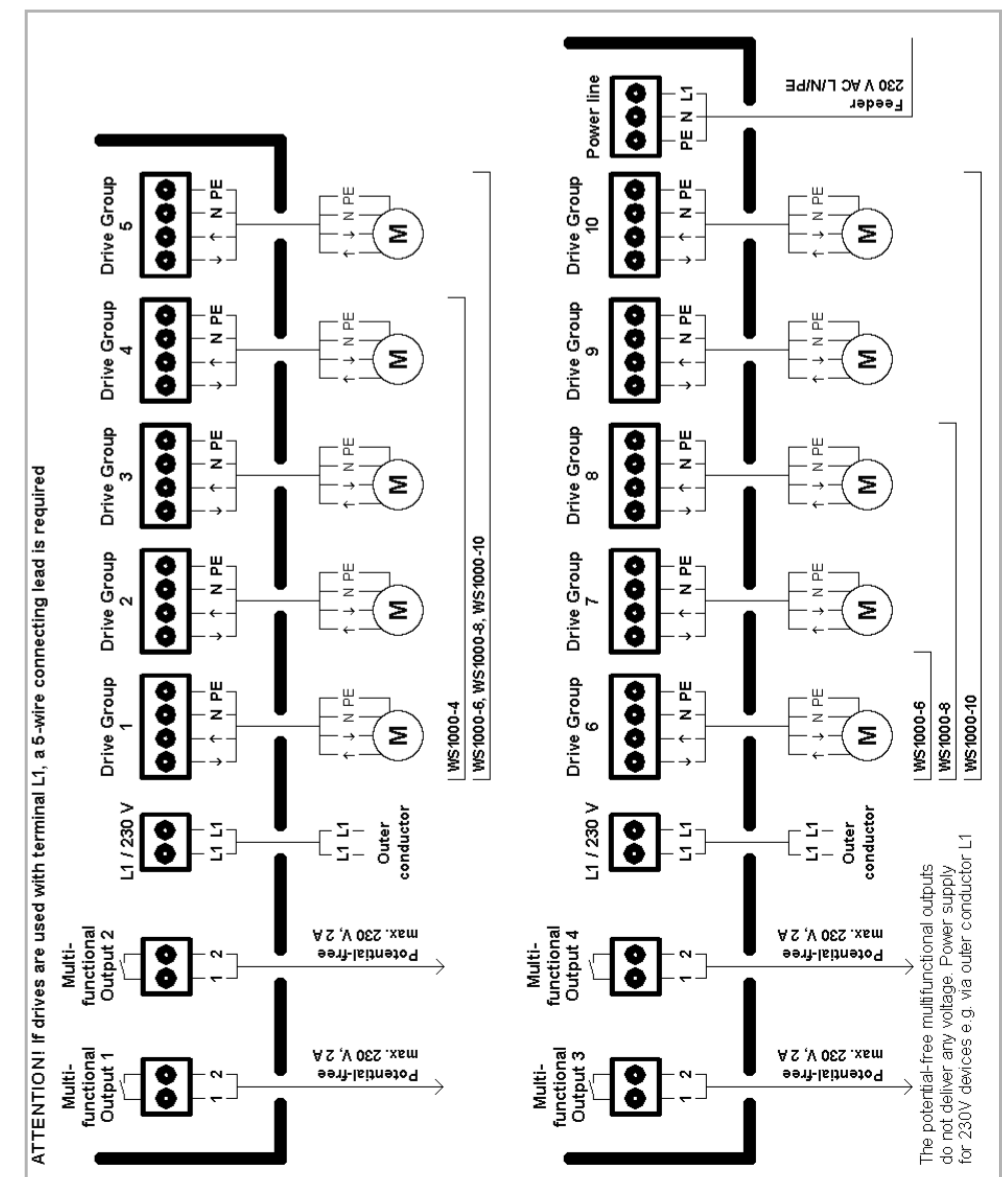

Inputs WS1000 Color:

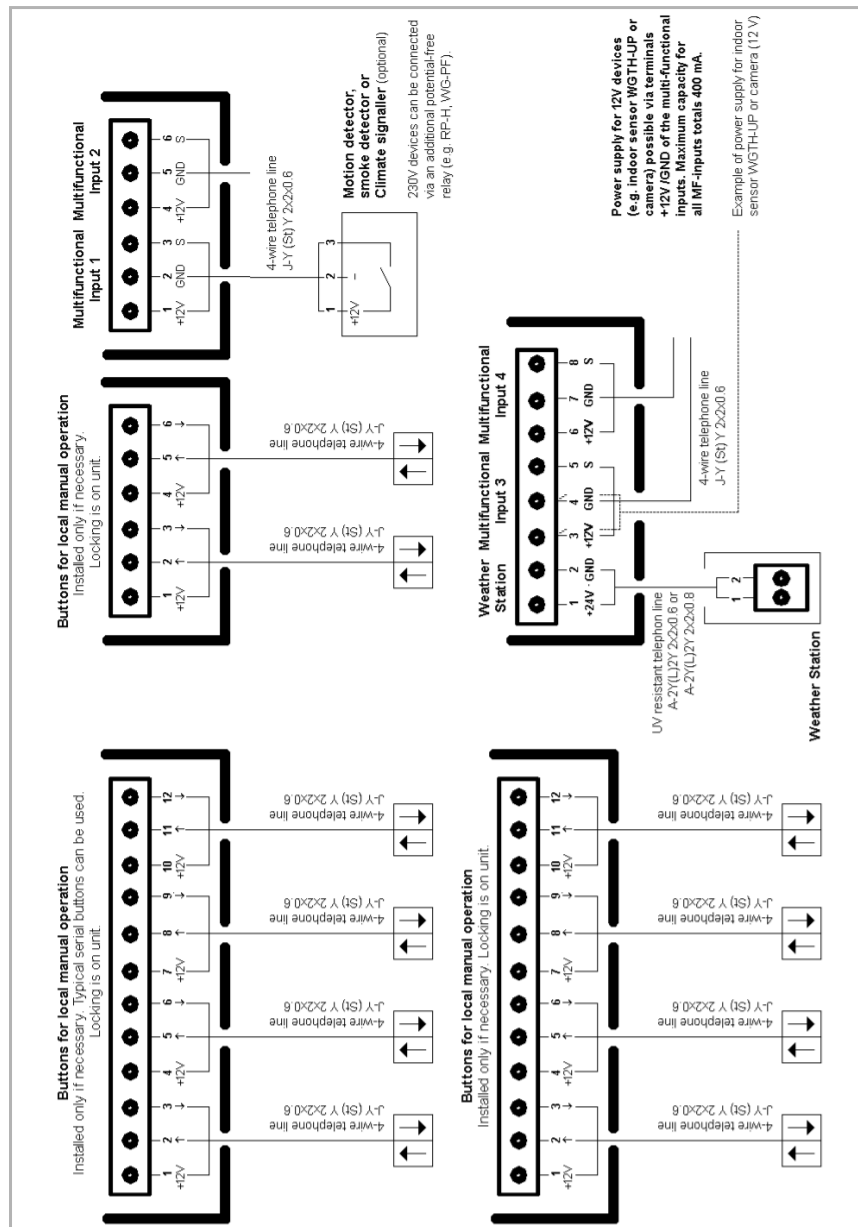

Connection examples for multifunctional outputs

Connecting 230 V consumers to MF outputs

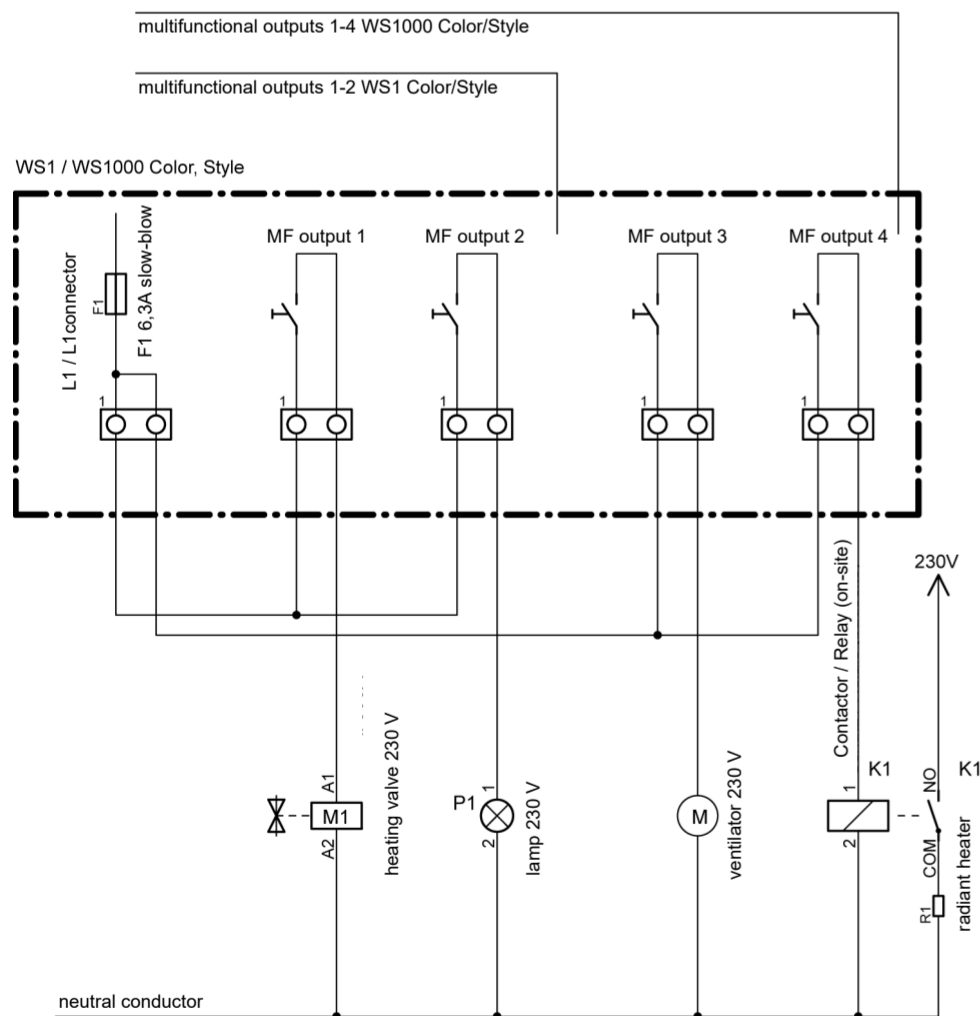

Connecting low-voltage consumers and potential-free contacts to MF outputs

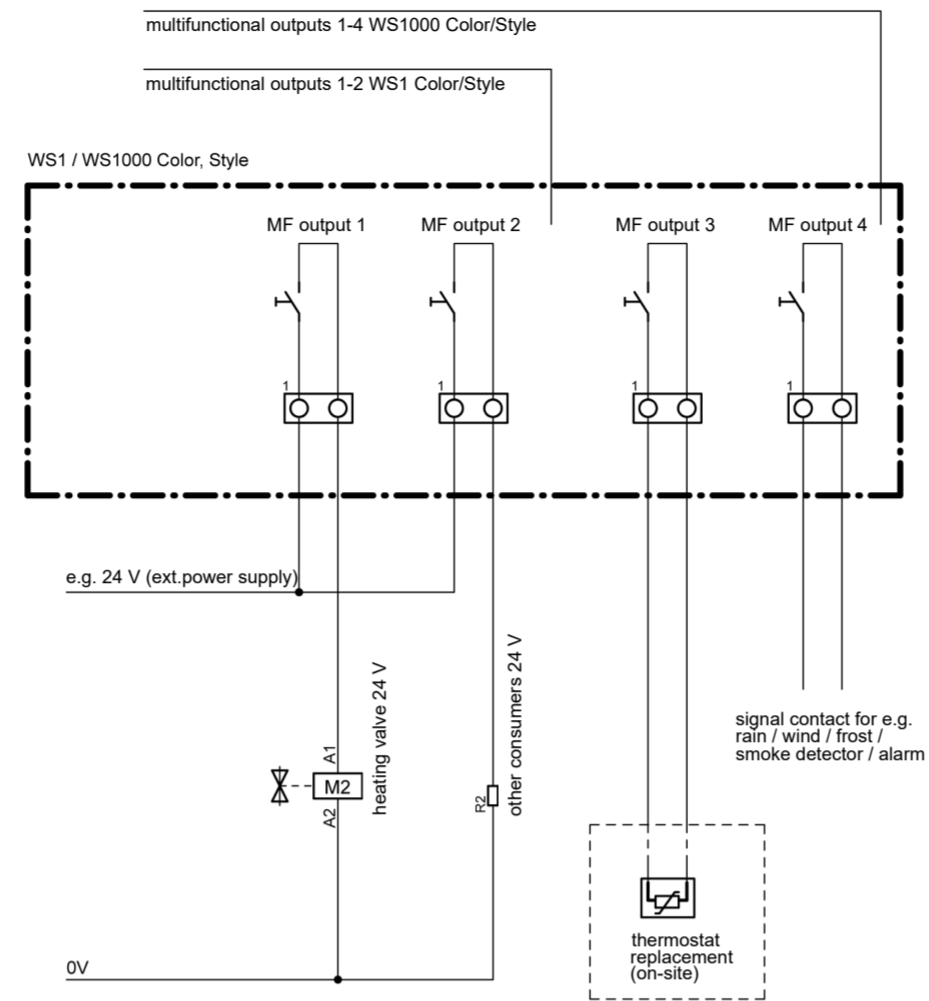

Technical specifications Control Unit WS1000 Color

Housing	Plastic material (partially painted)
Colours	<ul style="list-style-type: none"> • White glossy (similar to RAL 9003 Signal White) / light grey (similar to RAL 7035 Light Grey) • Aluminium (similar to RAL 9006 White Aluminium) / graphite (similar to RAL 7024 Graphite grey)
Mounting	Flush/cavity wall
Dimensions	Central unit approx. 250 × 182 × 43 (W × H × D, mm), concealed box approx. 235 × 169 × 62 (W × H × D, mm)
Ambient temperature	Operation 0...+55°C, Storage -30...+70°C
Ambient humidity	5...95% RH, avoid bedewing
Operating voltage	230 V AC, 50 Hz
Power consumption	Stand-by max. 16 W
Load capacity drive outputs	per drive output max. 400 W, total max. 1.5 kW
Frequency wireless channels	868.2 MHz
Degree of protection	IP 20

The product conforms with the provisions of EU directives.