



KIPI

KNX-IP Interface

ZSYKIPI

Application Program version: [1.0]
User Manual version: [1.0]_d

CONTENTS

Contents.....	2
Document Updates.....	3
1 Introduction	4
1.1 KIPI	4
1.2 Installation.....	5
2 Configuration.....	6
2.1 KNX to IP Interface.....	7
2.2 Programmer.....	7
2.2.1 Parallel Downloads.....	9
2.3 Additional Individual Addresses (Tunneling Addresses).....	10
2.4 LED Indicators	11
2.5 Hard Reset to Factory Defaults.....	12

DOCUMENT UPDATES

Version	Changes	Page(s)
[1.0]_d	Clarification about monitoring (only group monitor supported).	4, 7
[1.0]_c	Clarification about multicast IP address.	-
[1.0]_b	Minor corrections.	-

1 INTRODUCTION

1.1 KIPI

KIPI is the solution from Zennio for the **interconnection** of **KNX twisted-pair lines** and **Ethernet**.

It also provides a **connection point** for ETS to enable programming (up to five parallel connections) and monitoring the KNX line via IP.

These are the most outstanding features of this device:

- Maximum APDU length of 254 bytes.
- Up to **5 parallel connections from ETS** for programming and monitoring (via group monitor).
- No external power required.
- **High capacity buffer** for the reception of telegrams from the Ethernet network.
- **4 lighting indicators (LEDs)**: two state indicators for the lines (bus and Ethernet), one more IP factory reset indicator, and one additional indicator for the programming mode.

1.2 INSTALLATION

1. Ethernet connector.
2. KNX line status LED.
3. Ethernet status LED.
4. -
5. -
6. KNX line connector.
7. Programming LED.
8. Programming button.
9. DIN rail clamp.
10. IP factory reset button.
11. Factory reset LED.

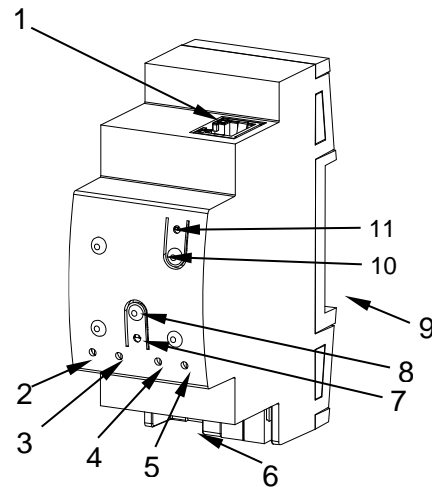

Figure 1 Element Diagram

Figure 1 shows a scheme with all the LED indicators and required connections. This device does not require an external power supply, it is powered through the KNX bus.

To couple a KNX twisted-pair (TP) line and a LAN network, the KNX bus (6) and Ethernet (1) cables must be connected. After the connection, the device can be conveniently mounted on the DIN rail by the usual procedure

The programming button (8) shown in Figure 1 may be pressed to set KIPI in **programming mode**. After a short press, the programming LED (7) will light in red.

Note: *if the programming button is held while plugging the device into the KNX bus, the device will enter into **safe mode**. In such case, the LED will blink in red every 0.5 seconds.*

The behaviour of the additional LEDs and the reset button will be described in sections 2.4 and 2.5.

For detailed information about the technical features of the device, as well as on security and installation procedures, please refer to the device **Datasheet**, bundled within the original packaging of the device and also available at <http://www.zennio.com>.

2 CONFIGURATION

To begin with the parameterisation process of the device, it is necessary, once the ETS program has been opened, to import the database of the product (KIPI application programs). Next, the device should be added to the project where desired.

This device has no parameters or communication objects. All the configuration is set by ETS properties.

The following network parameters can be configured in the "IP" panel of the "Properties" of the device:

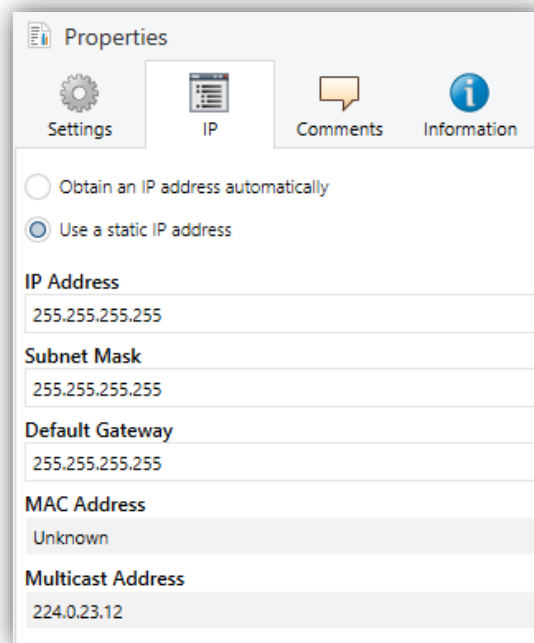

Figure 2 IP Configuration

- [Obtain an IP address automatically](#)¹. KIPI will automatically acquire an IP address whenever there is a DHCP server in the local network to which it is connected.
- [Use a static IP address](#). The following properties must be set manually:
 - **IP Address** [[0.0.0.0...255.255.255.255](#)].
 - **Subnet Mask** [[0.0.0.0...255.255.255.255](#)].

¹ The default values of each parameter will be highlighted in blue in this document, as follows: [[default/rest of options](#)].

- **Default Gateway** [[0.0.0.0...255.255.255.255](#)].

Note: *If a static IP is configured, it is important to make sure that no other device on the network has this IP assigned to it and that it does not belong to the DHCP range configured for the router, otherwise connection problems with the KIPI will be observed.*

In addition, the following information will be shown:

- **MAC Address.**
- **Multicast Address** [[224.0.23.12](#)]: IP address (reserved by the IANA organization for the KNXnet/IP protocol) used by ETS in this case, for discovering the available KNX-IP interfaces within the same network.

Once these properties have been entered an ETS programming is required to download the configuration to the device.

2.1 KNX TO IP INTERFACE

As indicated before, KIPI is an interface device intended for the interconnection between a KNX bus and an Ethernet network (LAN).

On the other hand, KIPI can be allocated within the project topology in ETS, as any other device. This step can be omitted when it is going to be used as interface, because there is no need to modify the default configuration (see previous section). However, when requiring to modify any property of KIPI, an individual address should be assigned in order to download.

2.2 PROGRAMMER

KIPI can be used in ETS as a **programming interface**. In addition to an IP address, they must be assigned a KNX individual address for this purpose.

Up to five simultaneous connections are allowed for performing downloads or for bus monitoring (via group monitor).

Note: *to detect the KIPI as a programmer in ETS, it needs to be connected to the same IP network as the PC.*

To use a device as a programmer simply select it in the ETS "Bus" tab under Connections → Interfaces.

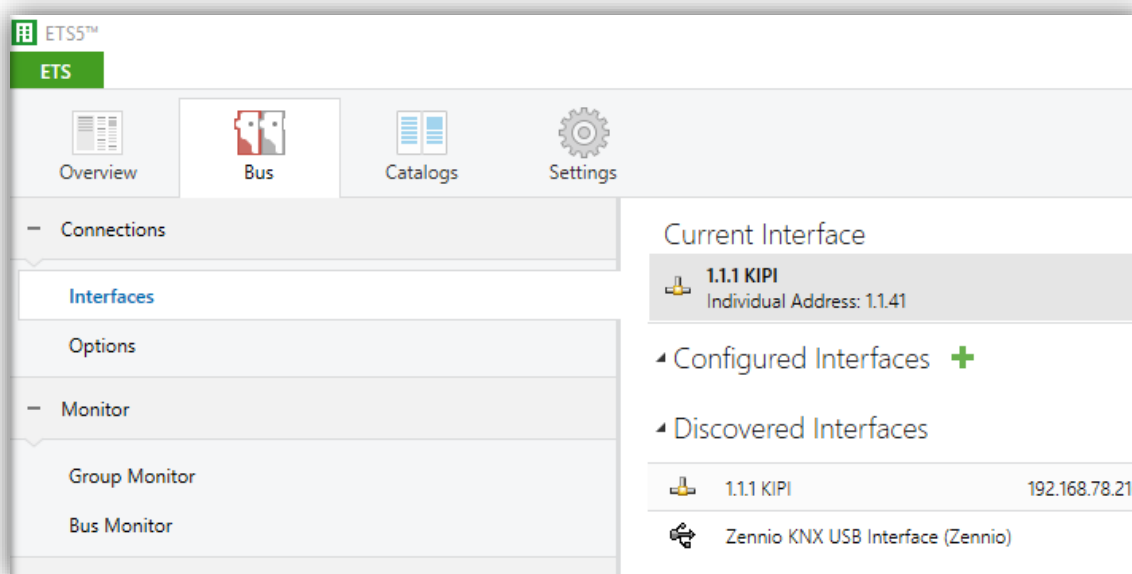

Figure 3 Selection of KIPI in the Bus Connections tab in ETS.

Or by selecting it at the bottom left after opening a project in ETS.

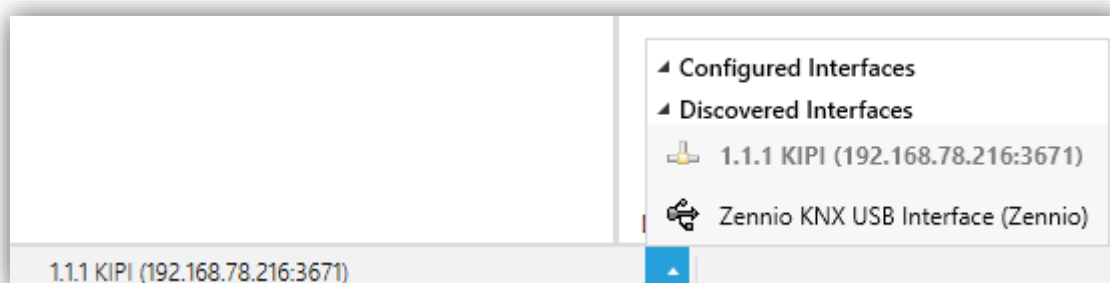

Figure 4 Selection of KIPI in a ETS project.

Important: *If the KIPI is selected as the programming interface to program itself it is recommended to first perform individual address download and then application download, rather than complete download (complete download causes a device restart and therefore communication with ETS is lost and the download is cancelled).*

2.2.1 PARALLEL DOWNLOADS

ETS offers the option to perform multiple parallel downloads within the same project. This option is only available for connections via a KNX-IP router or a KNX-IP interface. Certain conditions must be met:

- Each download must be performed on a different line.
- For each line, it is necessary to select one **KIPI** to perform the download.

Note: *There is a restriction: parallel downloads are **not available to download physical addresses**. When performing this type of downloads, the link device used by ETS is not the one configured for the line but the general one.*

In ETS5 this is configured in the line properties.

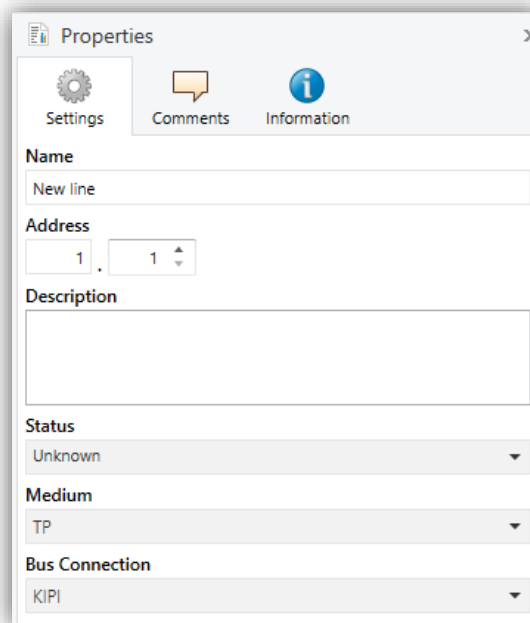

Figure 5 ETS5 parallel downloads configuration.

Note: *once the connection has been selected, it will not be available for the other lines.*

2.3 ADDITIONAL INDIVIDUAL ADDRESSES (TUNNELING ADDRESSES)

KIPI requires a specific individual address when acting as a programming interface (*tunneling*) other than the address of the device itself. Up to five simultaneous connections are possible, which implies that up to five different individual addresses must be configured.

Tunneling addresses are configured in ETS after adding the device to the project, in the same way as the physical address of the device, as shown in Figure 6:

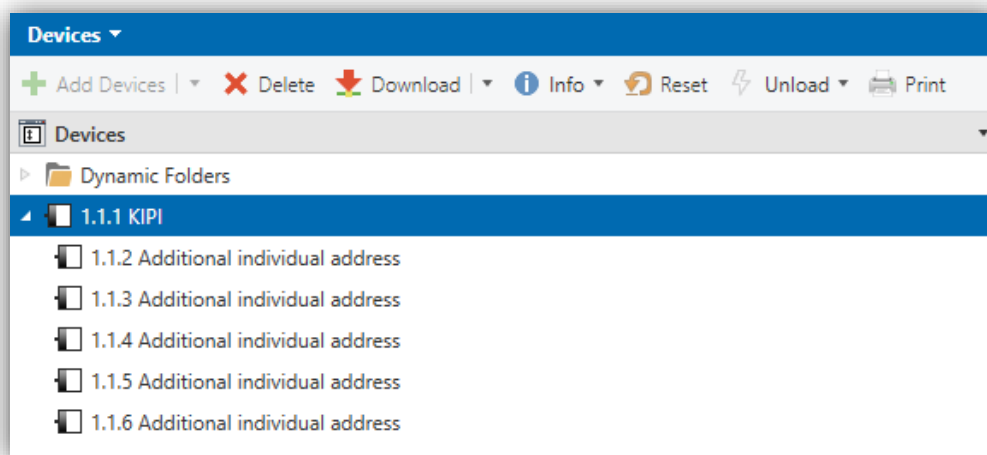

Figure 6 Set tunneling addresses.

After the individual KIPI address has been set, the five tunneling addresses are automatically set with consecutive values. This can be changed at any time.

Important: *KIPI tunnelling addresses must not match any of the addresses set to other devices on the system.*

2.4 LED INDICATORS

KIPI incorporates four LED lights on the top of the device that make it easy to monitor the status of the buses and to detect typical communication problems, as detailed next.

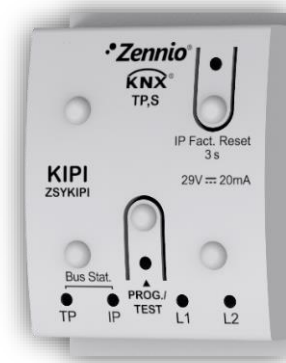

Figure 7 LEDs

- **KNX Line Status LED (TP):** shows the status of the primary bus.
 - OFF: error or KNX line not connected or not powered.
 - ON (green) = TP connection OK.

Note: *the update of the LED status can be delayed a few seconds after the trigger event, e.g., after the disconnection of the main line.*

- **Ethernet Line Status LED (IP):** shows the status of the secondary bus.
 - OFF: error or IP line not connected.
 - ON (green): Ethernet connection OK

- **Programming LED:**
 - OFF = normal operation.
 - ON (red) = programming mode active.

- **IP Factory Reset LED:**
 - OFF: normal operation.
 - ON (red): factory IP is restored (300 ms active).

2.5 HARD RESET TO FACTORY DEFAULTS

If “IP Factory Reset” button is **pressed for three seconds**, the device restores its default parameters (obtain an IP address via DHCP server). This IP configuration will remain until a new download is made.

When a long press is detected, the associated LED will light up in red for 300 ms. After this time, LED will switch off again.



Join and send us your inquiries
about Zennio devices:

<http://support.zennio.com>

Zennio Avance y Tecnología S.L.

C/ Río Jarama, 132. Nave P-8.11
45007 Toledo (Spain).

Tel. +34 925 232 002

www.zennio.com
info@zennio.com



RoHS