

Fujitsu VRF Air Conditioning
Gateway for the integration of Fujitsu VRF systems into KNX home automation
systems

USER MANUAL

Issue date: 01/2019 r1.0 ENGLISH

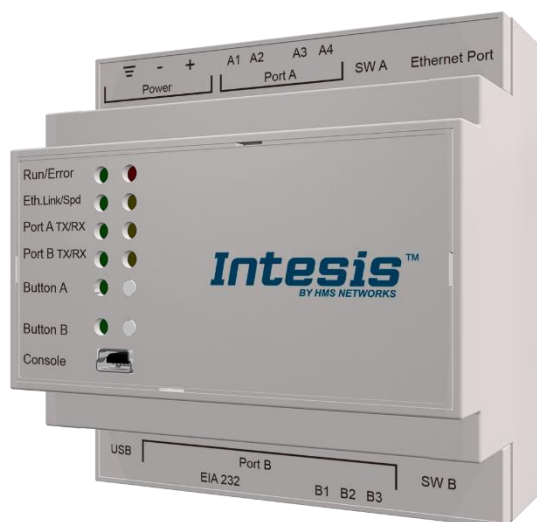

Important User Information

Disclaimer

The information in this document is for informational purposes only. Please inform HMS Industrial Networks of any inaccuracies or omissions found in this document. HMS Industrial Networks disclaims any responsibility or liability for any errors that may appear in this document.

HMS Industrial Networks reserves the right to modify its products in line with its policy of continuous product development. The information in this document shall therefore not be construed as a commitment on the part of HMS Industrial Networks and is subject to change without notice. HMS Industrial Networks makes no commitment to update or keep current the information in this document.

The data, examples and illustrations found in this document are included for illustrative purposes and are only intended to help improve understanding of the functionality and handling of the product. In view of the wide range of possible applications of the product, and because of the many variables and requirements associated with any particular implementation, HMS Industrial Networks cannot assume responsibility or liability for actual use based on the data, examples or illustrations included in this document nor for any damages incurred during installation of the product. Those responsible for the use of the product must acquire sufficient knowledge in order to ensure that the product is used correctly in their specific application and that the application meets all performance and safety requirements including any applicable laws, regulations, codes and standards. Further, HMS Industrial Networks will under no circumstances assume liability or responsibility for any problems that may arise as a result from the use of undocumented features or functional side effects found outside the documented scope of the product. The effects caused by any direct or indirect use of such aspects of the product are undefined and may include e.g. compatibility issues and stability issues.

Gateway for the integration of Fujitsu VRF systems into KNX home automation systems.

ORDER CODE	LEGACY ORDER CODE
INKNXFGL016O000	IBKNXFGL016O000

INDEX

1 Description 5

 1.1 Introduction 5

 1.1 Functionality 6

 1.2 Capacity of Intesis 6

2 KNX System 7

 2.1 Description 7

 2.2 Points definition 7

3 Connections 8

 3.1 Power device 9

 3.2 Connect to Fujitsu installation 9

 3.3 Connection to KNX 9

 3.4 Connection to the configuration tool 9

4 Set-up process and troubleshooting 10

 4.1 Pre-requisites 10

 4.2 Intesis MAPS. Configuration & monitoring tool for Intesis KNX series 10

 4.2.1 Introduction 10

 4.2.2 Connection 10

 4.2.3 Configuration tab 11

 4.2.4 KNX configuration 11

 4.2.5 Fujitsu configuration 14

 4.2.6 Signals 16

 4.2.7 Sending the configuration to Intesis 17

 4.2.8 Diagnostic 17

 4.2.9 Set-up procedure 19

5 Electrical & Mechanical Features 20

6 Dimensions 21

7 AC Unit Types compatibility 22

8 Error codes for Indoor and Outdoor Units 23

9 Appendix A – Communication Objects Table 25

1 Description

1.1 Introduction

This document describes the integration of Fujitsu VRF air conditioning systems into KNX home automation systems using gateway *Intesis KNX – Fujitsu VRF*.

The aim of this integration is to monitor and control your Fujitsu air conditioning system, from your KNX TP-1 installation. To do it so, Intesis performs as a one more KNX device, sending and receiving telegrams to group addresses in the KNX network.

Intesis makes available the Fujitsu air conditioning system indoor units' datapoints through independent KNX objects.

Up to 16 indoor units supported, depending on product version.

This document assumes that the user is familiar with KNX and Fujitsu technologies and their technical terms

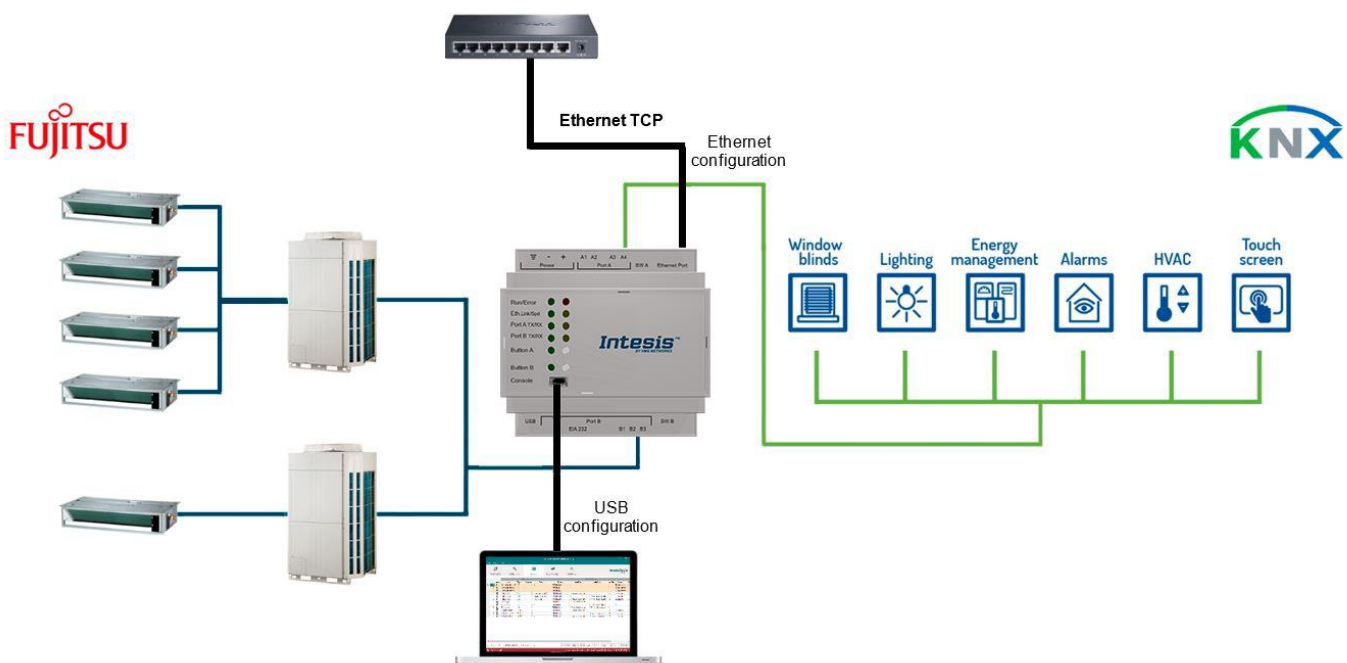

Integration of Fujitsu VRF systems into KNX control systems

1.1 Functionality

Intesis™ continuously monitors Fujitsu VRF network for all configured signals and keeps the updated status of all of them in its memory. It triggers updates on configured group addresses to KNX network on value change.

Each indoor unit is offered as a set of KNX objects.

Element	Object supported
Outdoor Unit	<ul style="list-style-type: none"> • Communication status • Status
Indoor Unit	<ul style="list-style-type: none"> • Status • Command • Communication status
General signals (all units)	<ul style="list-style-type: none"> • Command

1.2 Capacity of Intesis

Element	Max.	Notes
Number of indoor units	16	Number of indoor units that can be controlled through Intesis

Its order code is:

- INKNXFGL016O000: Model supporting up to 16 indoor units

2 KNX System

In this section, a common description for all Intesis KNX series gateways is given, from the point of view of KNX system which is called from now on *internal system*. Connection with the Fujitsu system is also called from now on *external system*.

2.1 Description

Intesis KNX connects directly to the KNX TP-1 bus and performs as one more device into the KNX system, with the same configuration and operational characteristics as other KNX devices.

Internally, the circuit part connected to the KNX bus is opto-isolated from the rest of the electronics.

Intesis KNX receives, manages and sends all the telegrams related to its configuration to the KNX bus.

On receiving WRITE telegrams of KNX group addresses associated to communication objects, the corresponding messages are sent to the external system (Fujitsu installation).

When a change in a signal of the external system is detected, a WRITE telegram is sent to the KNX bus (addressed with the group address associated to the corresponding group object), in order to maintain both systems synchronized in every moment.

The status of the KNX bus is checked continuously and, if a bus drop-down is detected, for example due to failure in the bus power supply, after the KNX bus is restored again, Intesis will send READ telegrams to group addresses of all communication objects marked with flag 'Ri'. The behavior of each individual point into Intesis is determined by the flags configured for the communication object. See details below.

2.2 Points definition

Every group object in configuration has following KNX properties:

Property	Description
Description	Descriptive information about the communication object or signal.
Object function	Information on range of values for the group object.
DPT	Datapoint type. It is the KNX data type used to encode the signal's value. It will depend on the type of signal associated in the external system in every case.
Group	It is the KNX group to which the point is associated. It is also the group to which the read (R), write (W), transmit (T), update (U) and read on init (Ri) flags are applied. It is the sending group.
Listening addresses	They are the addresses that can write on the group object, a part of the main group address.
R	Read. If this flag is activated, READ telegrams of this group address will be accepted.
Ri	Read on Init. If this flag is activated, the object will trigger corresponding READ request (on associated group address) on initialization.
W	Write. If this flag is activated, WRITE telegrams on this group object will be accepted.
T	Transmit. If this flag is activated, when the group object value changes, due to a change in the external system, a WRITE telegram of the associated group address will be sent to the KNX bus.
U	Update. If this flag is activated, UPDATE telegrams (response to READ telegrams) on this group object will be accepted.
Active	If activated, the point will be active in Intesis, if not, the behavior will be as if the point is not defined. This allows deactivating points without the need of delete them for possible future use.

These properties are common for all Intesis KNX series gateways. Although each integration may have specific properties according to the type of signals of the external system.

See list of communication objects in section 9.

3 Connections

Find below information regarding the Intesis connections available.

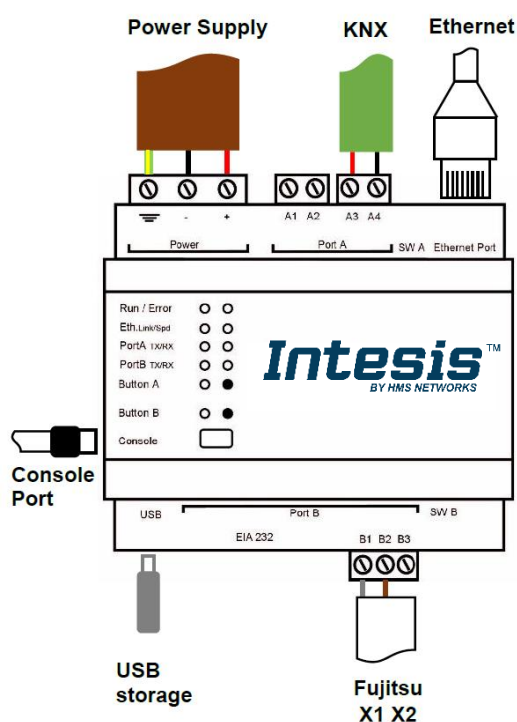

Power Supply

Must use NEC Class 2 or Limited Power Source (LPS) and SELV rated power supply.

If using DC power supply:

Respect polarity applied of terminals (+) and (-). Be sure the voltage applied is within the range admitted (check table below). The power supply can be connected to earth but only through the negative terminal, never through the positive terminal.

If using AC power supply:

Make sure the voltage applied is of the value admitted (24 Vac). Do not connect any of the terminals of the AC power supply to earth, and make sure the same power supply is not supplying any other device.

Ethernet

Connect the cable coming from the IP network to the connector ETH of the gateway. Use an Ethernet CAT5 cable. If communicating through the LAN of the building, contact the network administrator and make sure traffic on the port used is allowed through all the LAN path (check the gateway user manual for more information). Default IP is 192.168.100.246. DHCP is enabled by default.

PortA / KNX

Connect the KNX TP1 bus to connectors A3 (+) and A4 (-) of gateway's PortA. Respect the polarity.

PortB / Fujitsu VRF

Connect the terminals (X1 X2) of Fujitsu Outdoor Unit to the connectors B1 and B2 of gateway's PortB. There is no polarity to be respected.

Console Port

Connect a mini-type B USB cable from your computer to the gateway to allow communication between the Configuration Software and the gateway. Remember that Ethernet connection is also allowed. Check the user manual for more information.

USB

Connect a USB storage device (not a HDD) if required. Check the user manual for more information.

Ensure proper space for all connectors when mounted (see section 6)

3.1 Power device

The first step to perform is to power up the device. To do so, a power supply working with any of the voltage range allowed is needed (check section 0). Once connected the ON led will turn on.

WARNING! In order to avoid earth loops that can damage the gateway, and/or any other equipment connected to it, we strongly recommend:

- The use of DC power supplies, floating or with the negative terminal connected to earth. **Never use a DC power supply with the positive terminal connected to earth.**
- The use of AC power supplies only if they are floating and not powering any other device.

3.2 Connect to Fujitsu installation

Use the Port B connector of the Intesis device in order to connect Fujitsu VRF bus to the Intesis. Remember to follow all safety precautions indicated by Fujitsu.

Connect the terminals (X1 X2) of Fujitsu Outdoor Unit to the connectors B1 and B2 of gateway's PortB. Bus is not sensitive to polarity.

3.3 Connection to KNX

Connect the KNX TP1 bus to connectors A3 (+) and A4 (-) of gateway's PortA. Respect the polarity.

3.4 Connection to the configuration tool

This action allows the user to have access to configuration and monitoring of the device (more information can be found in the configuration tool User Manual). Two methods to connect to the PC can be used:

- **Ethernet:** Using the Ethernet port of Intesis.
- **USB:** Using the console port of Intesis, connect a USB cable from the console port to the PC.

4 Set-up process and troubleshooting

4.1 Pre-requisites

It is necessary to have a KNX installation, device or interface operative and well connected to the corresponding KNX port of Intesis. It is also required to have a Fujitsu VRF installation, with accessible X1 X2 port for connection of Intesis.

Connectors, connection cables, PC to use the configuration tool and other auxiliary material, if needed, are not supplied by HMS Industrial Networks S.L.U for this standard integration.

Items supplied by HMS Networks for this integration are:

- Intesis gateway.
- Link to download the configuration tool.
- USB Console cable to communicate with Intesis.
- Product documentation.

4.2 Intesis MAPS. Configuration & monitoring tool for Intesis KNX series

4.2.1 Introduction

Intesis MAPS is a Windows® compatible software developed specifically to monitor and configure Intesis new generation gateways.

The installation procedure and main functions are explained in the *Intesis MAPS KNX User Manual*. This document can be downloaded from the link indicated in the installation sheet supplied with the Intesis device or in the product website at www.intesis.com

In this section, only the specific case of Fujitsu to KNX systems will be covered.

Please check the Intesis MAPS KNX User Manual for specific information about the different parameters and how to configure them.

4.2.2 Connection

To configure the Intesis connection parameters press on the **Connection** button in the *menu bar*.

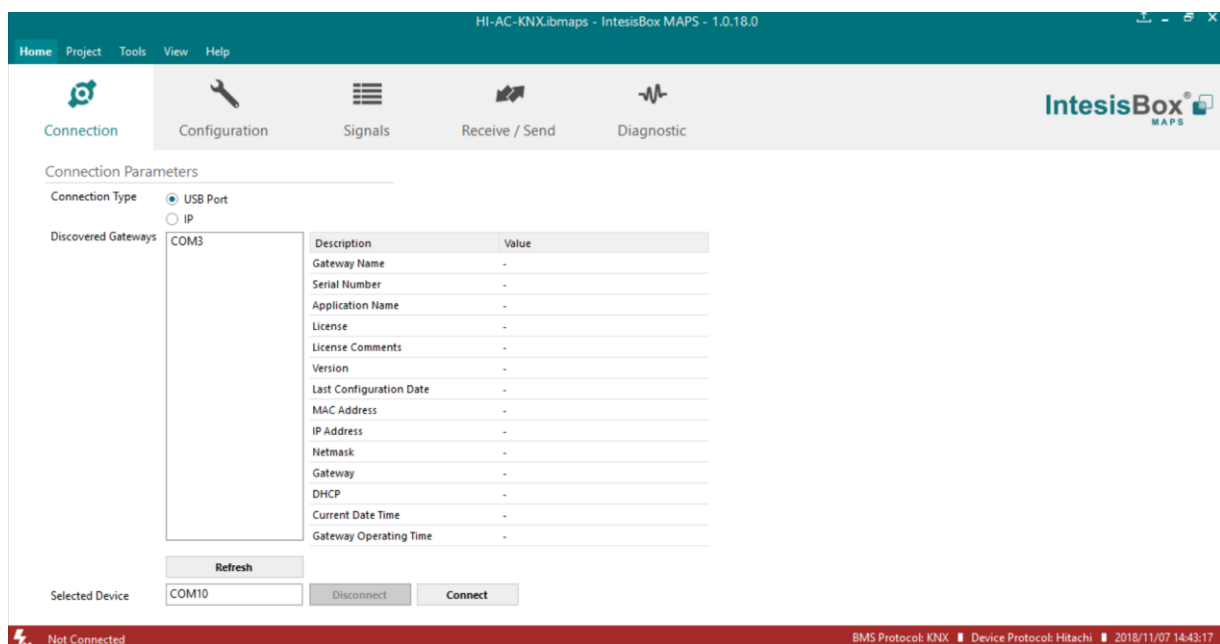

Figure 4.1 MAPS connection

4.2.3 Configuration tab

Select the **Configuration** tab to configure the connection parameters. Three subsets of information are shown in this window: General (Gateway general parameters), KNX (KNX interface configuration) and Fujitsu (Fujitsu interface parameters).

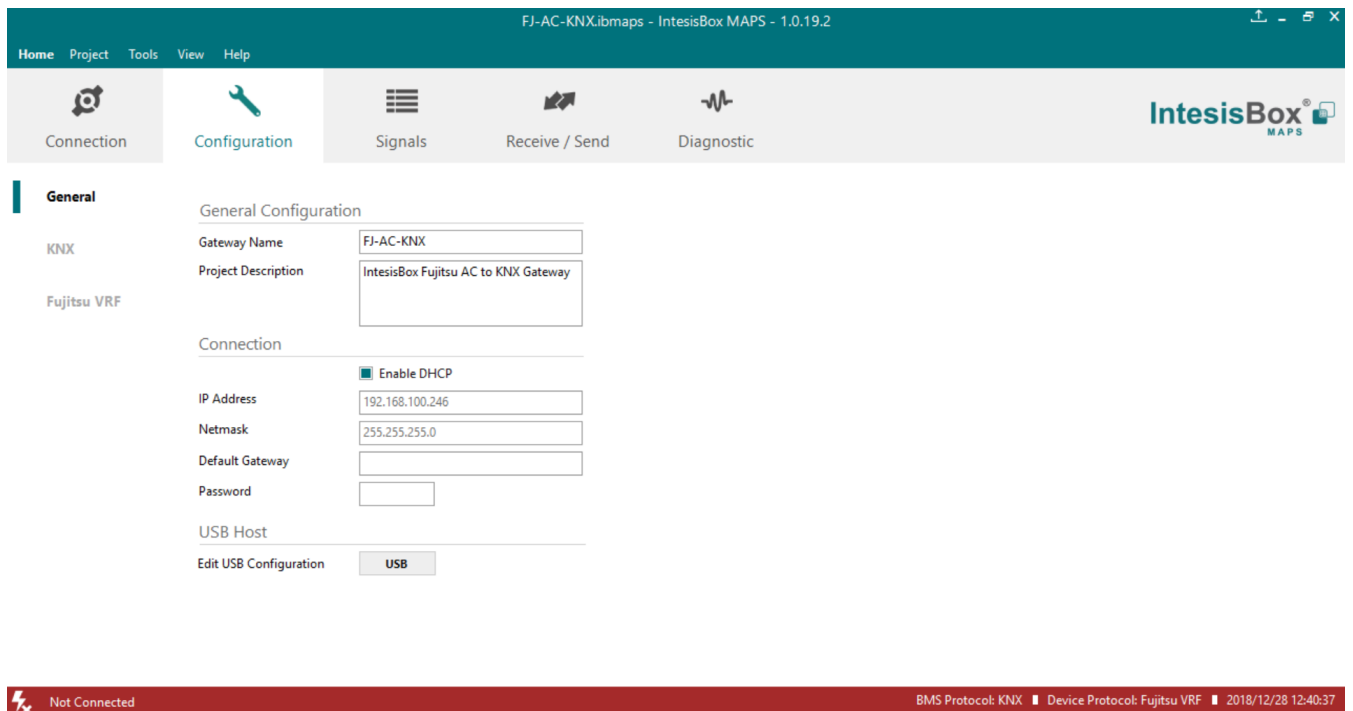

Figure 4.2 Intesis MAPS configuration tab

4.2.4 KNX configuration

Set parameters of KNX interface of Intesis.

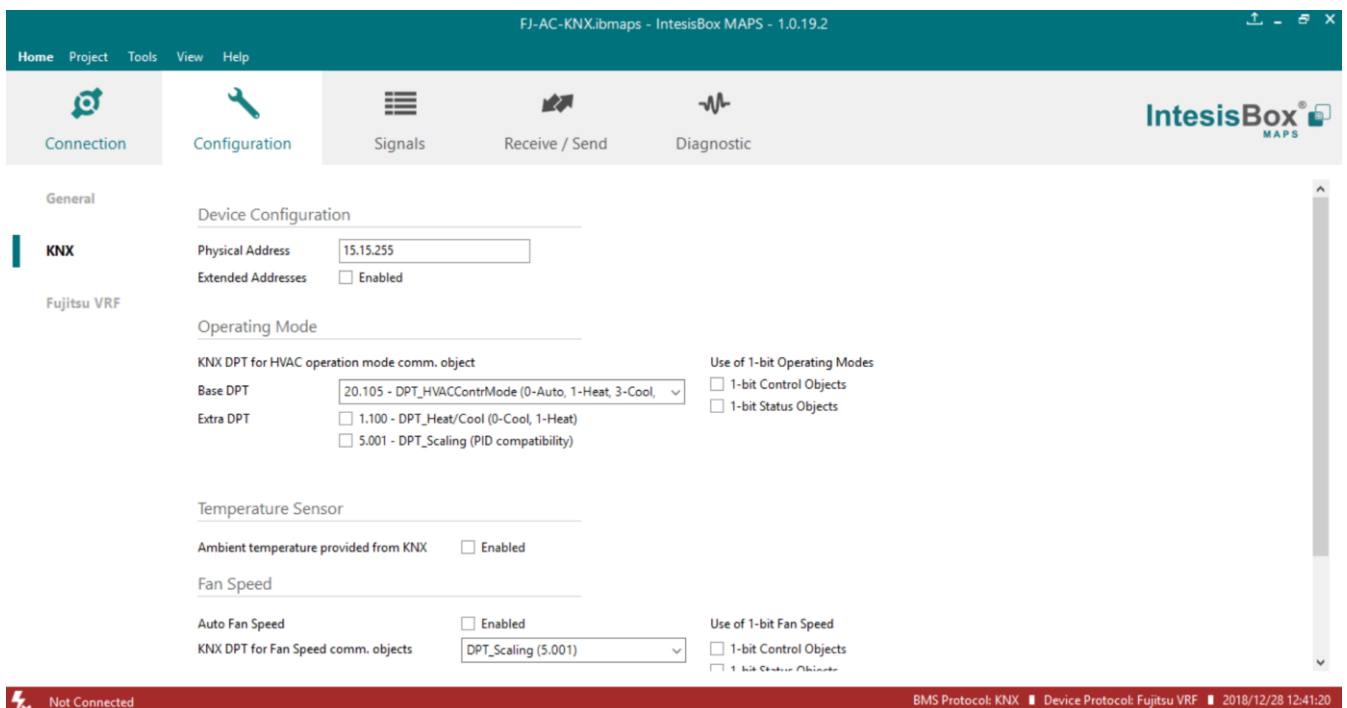

Figure 4.3 Intesis MAPS KNX configuration tab

1. Device configuration

1.1. Physical Address. KNX physical address of the device in the network

1.2. Extended Addresses. Enables usage of KNX Extended addresses (range from 16/0/0 to 32/7/255).

2. Operating Mode. Settings related to KNX interface for control and feedback of AC unit's operating mode.

2.1. KNX DPT for HVAC operation mode comm object. Base DPT. Base DPT to use for control/monitor the operating mode. Following DPT types are offered:

- DPT_20.105. DPT_HVACContrMode: 0-Auto, 1-Heat, 3-Cool, 9-Fan, 14-Dry
- DPT_5.x (non-standarized): 0-Auto, 1-Heat, 2-Dry, 3-Fan, 4-Cool

2.2. KNX DPT for HVAC operation mode comm object. Extra DPT. Additional DPT to use for control/monitor the operating mode.

- DPT_1.100. DPT_Heat/Cool: 0-Cool, 1-Heat.
- DPT_5.001. DPT_Scaling: Enables objects "Control_Heat Mode & On" and "Control_Cool Mode & On". Their type is DPT_Scaling (0..100%), and their ending is to be able to control parameters On/Off, Cool/Heat of indoor unit from a single percentage object. They are meant to provide compatibility with certain thermostats oriented to the operation of valves for Heating/Cooling. Whenever a value > 0% is received at each of these two objects, the corresponding operating mode and ON operation is sent to the indoor unit. Whenever both values are 0%, indoor unit is set to OFF

2.3. Use of 1-bit Operating Modes. 1-bit Control Objects. Enables a bit-type object for the control of each operating mode.

2.4. Use of 1-bit Operating Modes. 1-bit Status Objects. Enables a bit-type object for monitoring each operating mode.

3. Temperature Sensor.

3.1. Ambient temperature provided from KNX. Enables object Control_KNX ambient temperature.



NOTE: Indoor unit does not accept, by itself, that an ambient temperature for control of operation of the indoor unit is provided. To allow regulation of indoor unit according to a temperature reference from KNX, what Intesis does is passing a different temperature setpoint to the indoor unit than the one required by the user. The passed setpoint is such that the difference 'Ambient temperature reported by Fujitsu IU – AC setpoint' is equal to 'Ambient temperature reported by KNX – AC setpoint required by KNX', using the following formula:

$$\text{"AC Setp. Temp"} = \text{"AC Ret. Temp"} - (\text{"KNX Amb. Temp."} - \text{"KNX Setp. Temp"})$$

Where:

- AC Setp. Temp: AC indoor unit setpoint temperature
- AC Ret. Temp: AC indoor unit return temperature
- KNX Amb. Temp.: Ambient temperature provided from KNX
- KNX Setp. Temp: Setpoint temperature provided from KNX

Consequently, when using this feature (Ambient temp provided from KNX), setpoint at AC and setpoint in KNX will not necessarily be the same (actually, user will not be able to operate setpoint from AC System controllers as the remote controller).

4. Fan Speed. Settings related to KNX interface for control and feedback of AC unit's fan speed.

4.1. Auto Fan Speed. Configures availability of Auto Fan Speed control/monitoring objects. Necessary if your indoor unit has auto fan speed.

- 4.2. KNX DPT for Fan Speed comm objects. DPT_5.001, DPT_Scaling.** Control/monitoring of Fan Speed is performed by means of scaling (percentage) objects. Thresholds for control object and values for status object will vary according to number of fanspeeds of the unit.
- 4.2. KNX DPT for Fan Speed comm objects. DPT_5.010, DPT_Value_1_Ucount.** Control/monitoring of Fan Speed is performed by means of enumerated values.
- 4.4. Use of 1-bit Fan Speed. 1-bit Control Objects.** Enables a bit-type object for control of fan speed.
- 4.5. Use of 1-bit Fan Speed. 1-bit Status Objects.** Enables a bit-type object for monitoring of each fan speed.
- 5. Vanes Position.** Settings related to KNX interface for control and feedback of AC unit's vanes position.
- 4.1. Auto&Swing Vanes.** Configures availability of Auto and Swing control/monitoring objects.
- 4.2. KNX DPT for Vane Position comm objects. DPT_5.001, DPT_Scaling.** Control/monitoring of Vanes Positions is performed by means of scaling (percentage) objects. Thresholds for control object and values for status object will vary according to number of vanes positions of the unit.
- 4.2. KNX DPT for Vane Position comm objects. DPT_5.010, DPT_Value_1_Ucount.** Control/monitoring of Vanes Positions is performed by means of enumerated values.
- 4.4. Use of 1-bit Fan Speed. 1-bit Control Objects.** Enables a bit-type object for control of Vanes Positions.
- 4.5. Use of 1-bit Fan Speed. 1-bit Status Objects.** Enables a bit-type object for monitoring of each Vanes Position.

4.2.5 Fujitsu configuration

Set parameters for connection with Fujitsu's installation.

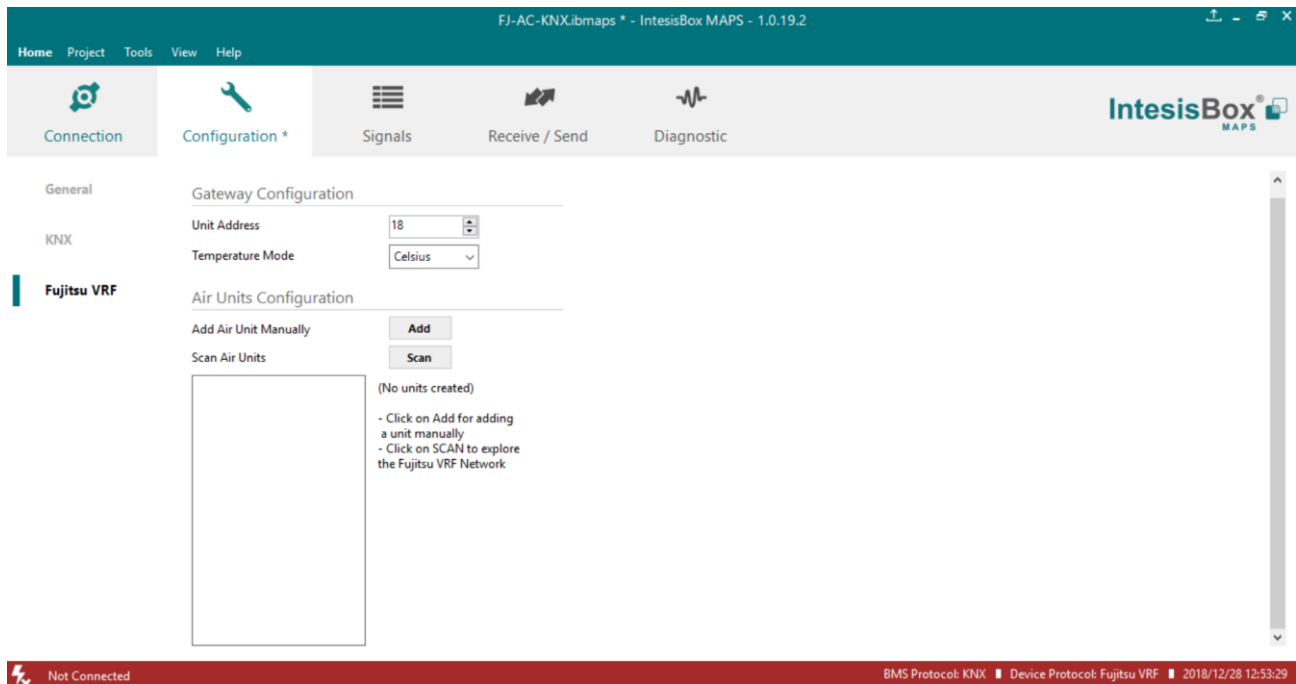

Figure 4.4 Intesis MAPS Fujitsu configuration tab

- 1. Unit Address:** Enter the gateway unit address of Fujitsu's network (values from 3 to 18 with no duplication within the same VRF network).
- 2. Temperature Mode:** Enter the desired temperature units to be used (Celsius or Fahrenheit).
- 3. Add Air Unit Manually:** Use this option to introduce units manually in the configuration.

Figure 4.5 Add units manually

1. Scan Air Units:

Use this function to scan the VRF network automatically to look for the current units connected to the system. Error window will appear if there is a problem in the connection with VRF bus (units not powered, bus not connected, ...).

A progress bar will appear during the scan, which will take up to a few minutes.

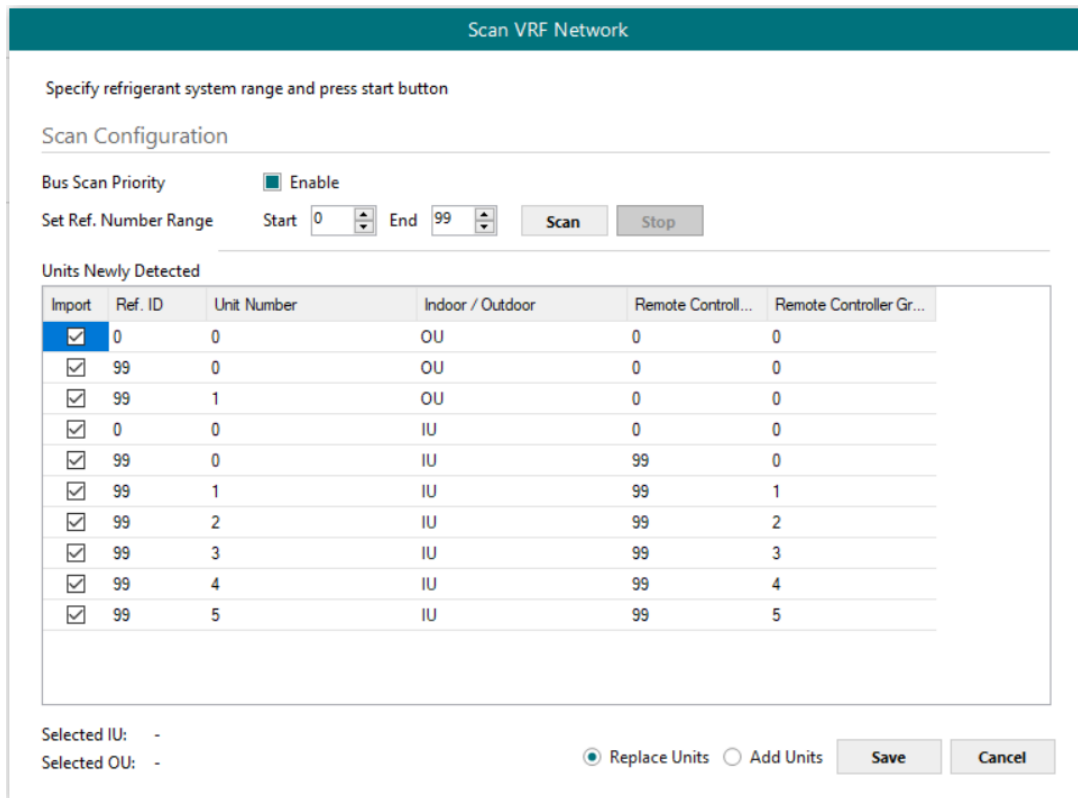

Figure 4.6 Intesis MAPS Scan Fujitsu Units window

Select with its checkbox units to add (or replace) in installation, according to selection **Replace Units / Add Units**. After units to be integrated are selected, click button **Apply**, and changes will appear in previous **Units Configuration** window.

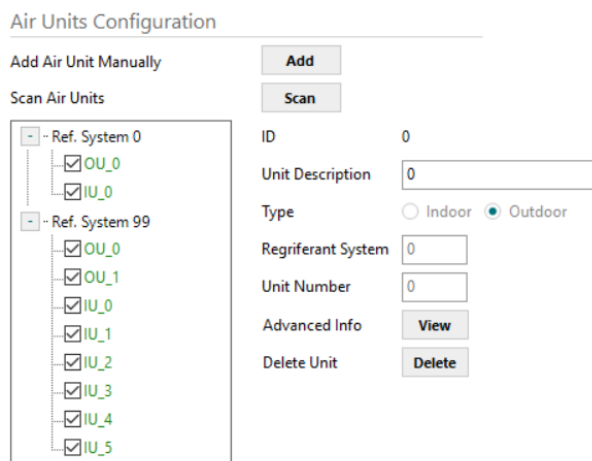

Figure 4.7 Intesis MAPS Fujitsu configuration tab after importing scan results

4.2.6 Signals

All available KNX objects, its corresponding description and other main parameters are listed in the signals tab.

#	Active	Description	Object Function	DPT	Sending	Listening	U	T	Ri	W	R	Unit Descripti...	Ref. System	Unit Number	Type of Unit
1	<input checked="" type="checkbox"/>	Control_Gateway ES	0-Disable energ...	1.003: enable	0/0/15					W	R	-	-	-	-
2	<input checked="" type="checkbox"/>	Status_Gateway ES	0-Disable energ...	1.003: enable	0/0/16			T		R	R	-	-	-	-
3	<input checked="" type="checkbox"/>	Status_Gateway error	0-No error, 1-Er...	1.005: alarm	0/0/17			T		R	R	-	-	-	-
4	<input checked="" type="checkbox"/>	Status_Gateway error code	0-No error, X-Er...	8.x	0/0/18			T		R	R	-	-	-	-
5	<input checked="" type="checkbox"/>	On/Off (all units)	0-Off, 1-On	1.001: switch	0/0/19					W	R	-	-	-	-
6	<input checked="" type="checkbox"/>	Operating mode (all units)	0-Auto, 1-Heat...	20.105: HVAC ContrMode	0/0/20					W	R	-	-	-	-
7	<input checked="" type="checkbox"/>	Fan speed (all units)	1-Quiet, 2-Low...	5.x	0/0/22					W	R	-	-	-	-
8	<input checked="" type="checkbox"/>	Fan speed AUTO (all units)	1-Set auto fan...	1.001: switch	0/0/23					W	R	-	-	-	-
9	<input checked="" type="checkbox"/>	Temperature setpoint (°C) (all units)	Cool:19..30 °C; ...	9.001: temperature (C)	0/0/24					W	R	-	-	-	-
10	<input checked="" type="checkbox"/>	Remote control disablement	0-No disabled, ...	1.002: boolean	0/0/25					W	R	-	-	-	-
11	<input checked="" type="checkbox"/>	Control_Capacity save	Thresholds (0%...	5.001: percentage (0..100%)	0/1/1					W	R	0	0	0	OU
12	<input checked="" type="checkbox"/>	Status_Capacity save	Thresholds (0%...	5.001: percentage (0..100%)	0/1/2			T		R	R	0	0	0	OU
13	<input checked="" type="checkbox"/>	Control_Forced off	0-Not forced, 1...	1.002: boolean	0/1/3					W	R	0	0	0	OU
14	<input checked="" type="checkbox"/>	Status_Forced off	0-Not forced, 1...	1.002: boolean	0/1/4			T		R	R	0	0	0	OU
15	<input checked="" type="checkbox"/>	Status_Error	0-No error, 1-Er...	1.005: alarm	0/1/5			T		R	R	0	0	0	OU
16	<input checked="" type="checkbox"/>	Status_Error code	0-No error, 1-Er...	8.x	0/1/6			T		R	R	0	0	0	OU
17	<input checked="" type="checkbox"/>	Status_Exists	0-Not exist,1-Ex...	1.001: switch	2/1/2			T		R	R	0	0	0	IU
18	<input checked="" type="checkbox"/>	Control_On/Off	0-Off,1-On	1.001: switch	2/1/3					W	R	0	0	0	IU
19	<input checked="" type="checkbox"/>	Status_On/Off	0-Off,1-On	1.001: switch	2/1/4			T		R	R	0	0	0	IU
20	<input checked="" type="checkbox"/>	Control_Operation mode	0-Auto, 1-Heat...	20.105: HVAC ContrMode	2/1/5					W	R	0	0	0	IU
21	<input checked="" type="checkbox"/>	Status_Operation mode	0-Auto, 1-Heat...	20.105: HVAC ContrMode	2/1/6			T		R	R	0	0	0	IU
22	<input checked="" type="checkbox"/>	Control_Fan speed scaling	Thresholds (0%...	5.001: percentage (0..100%)	2/1/25					W	R	0	0	0	IU
23	<input checked="" type="checkbox"/>	Status_Fan speed scaling	Thresholds (25...	5.001: percentage (0..100%)	2/1/26			T		R	R	0	0	0	IU
24	<input checked="" type="checkbox"/>	Control_Vanes U-D scaling	Thresholds (0%...	5.001: percentage (0..100%)	2/1/47					W	R	0	0	0	IU
25	<input checked="" type="checkbox"/>	Status_Vanes U-D scaling	Thresholds (25...	5.001: percentage (0..100%)	2/1/48			T		R	R	0	0	0	IU
26	<input checked="" type="checkbox"/>	Control_Vanes U-D swing	0-Swing off; 1-S...	1.001: switch	2/1/57					W	R	0	0	0	IU
27	<input checked="" type="checkbox"/>	Status_Vanes U-D swing	0-Swing off; 1-S...	1.001: switch	2/1/58			T		R	R	0	0	0	IU
28	<input checked="" type="checkbox"/>	Control_Vanes L-R scaling	Thresholds (0%...	5.001: percentage (0..100%)	2/1/61					W	R	0	0	0	IU
29	<input checked="" type="checkbox"/>	Status_Vanes L-R scaling	Thresholds (20...	5.001: percentage (0..100%)	2/1/62			T		R	R	0	0	0	IU

Figure 4.8 Intesis MAPS Signals tab

4.2.7 Sending the configuration to Intesis

When the configuration is finished, follow the next steps.

1.- Save the project (Menu option **Project->Save**) on your hard disk (more information in Intesis MAPS User Manual).

2.- Go to tab '**Receive / Send**' of MAPS, and in **Send** section, press **Send** button. Intesis will reboot automatically once the new configuration is loaded.

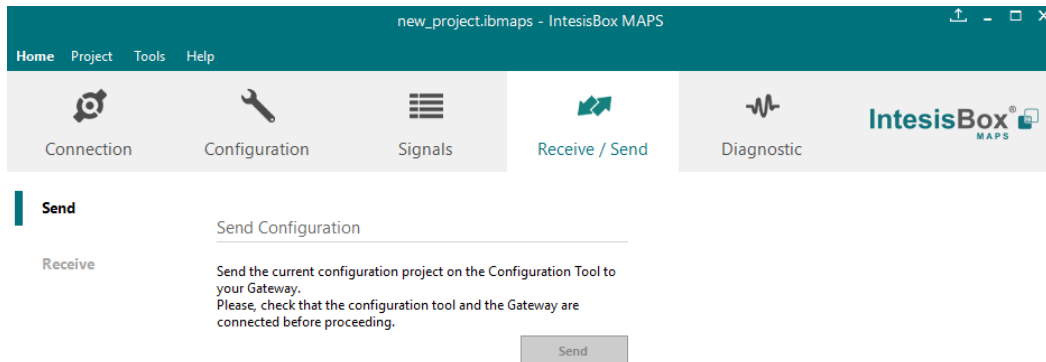

Figure 4.9 Intesis MAPS Receive/Send tab

After any configuration change, do not forget to send the configuration file to the Intesis using the Send button in the Receive / Send section.

4.2.8 Diagnostic

To help integrators in the commissioning tasks and troubleshooting, the Configuration Tool offers some specific tools and viewers.

In order to start using the diagnostic tools, connection with the Gateway is required.

The Diagnostic section is composed by two main parts: Tools and Viewers.

- **Tools**
Use the tools section to check the current hardware status of the box, log communications into compressed files to be sent to the support, change the Diagnostic panels' view or send commands to the gateway.
- **Viewers**
In order to check the current status, viewer for the Internal and External protocols are available. It is also available a generic Console viewer for general information about communications and the gateway status and finally a Signals Viewer to simulate the BMS behavior or to check the current values in the system.

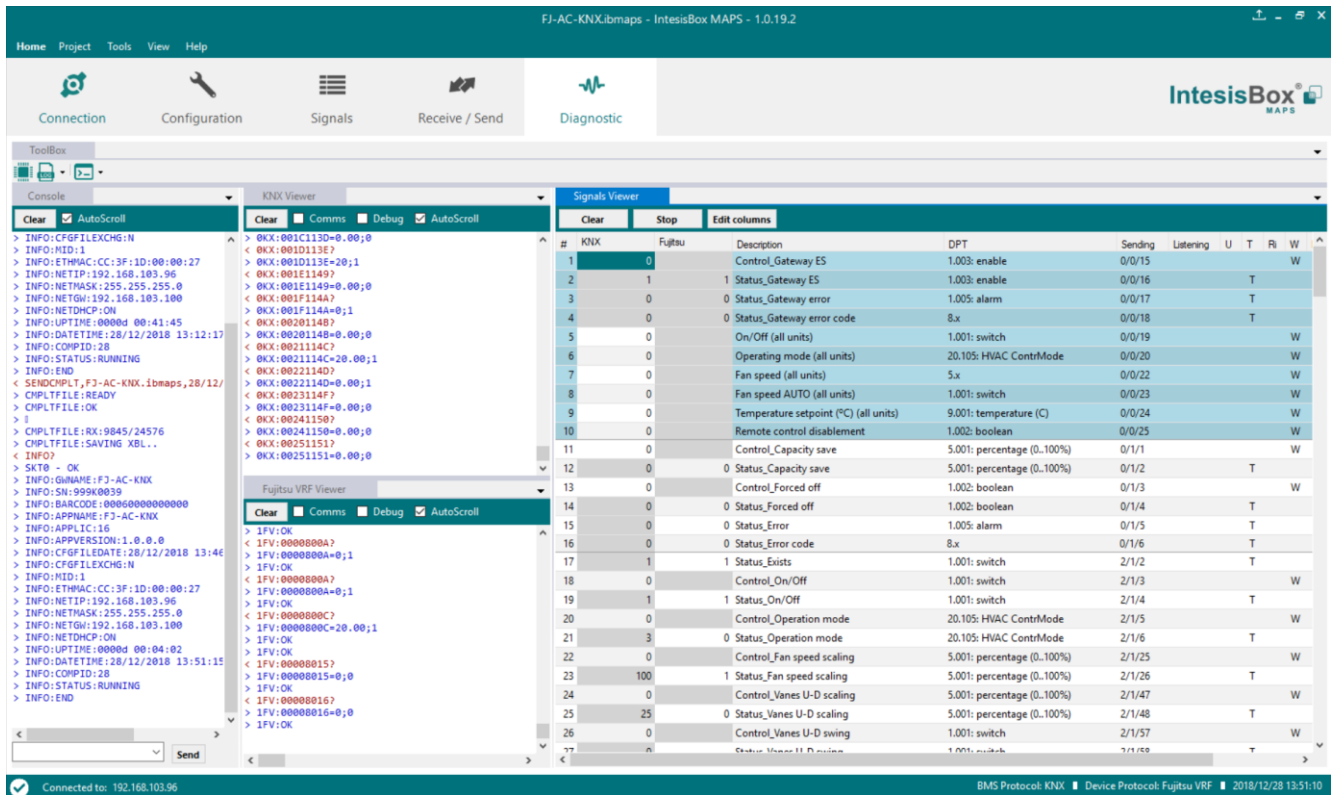

Figure 4.10 Diagnostic

More information about the Diagnostic section can be found in the Configuration Tool manual.

4.2.9 Set-up procedure

1. Install Intesis MAPS on your laptop, use the setup program supplied for this and follow the instructions given by the Installation wizard.
2. Install Intesis in the desired installation site. Installation can be on DIN rail or on a stable not vibrating surface (DIN rail mounted inside a metallic industrial cabinet connected to ground is recommended).
3. Connect the KNX communication cable coming from the KNX network to the port marked as Port A on Intesis (More details in section 3).
4. Connect the communication cable coming from the Fujitsu VRF installation to the port marked as Port B of Intesis (More details in section 3).
5. Power up Intesis. The supply voltage can be 9 to 36 Vdc or just 24 Vac. Take care of the polarity of the supply voltage applied.

WARNING! In order to avoid earth loops that can damage Intesis and/or any other equipment connected to it, we strongly recommend:

- The use of DC power supplies, floating or with the negative terminal connected to earth. **Never use a DC power supply with the positive terminal connected to earth.**
 - The use of AC power supplies only if they are floating and not powering any other device.
6. If you want to connect using IP, connect the Ethernet cable from the laptop PC to the port marked as Ethernet of Intesis (More details in section 3).

If you want to connect using USB, connect the USB cable from the laptop PC to the port marked as Console of Intesis (More details in section 3).

7. Open Intesis MAPS, create a new project selecting a copy of the one named **INKNXFGL0---000**.
8. Modify the configuration as desired, save it and download the configuration file to Intesis as explained in the Intesis MAPS user manual.
9. Visit the Diagnostic section and check that there is communication activity, some TX frames and some other RX frames. This means that the communication with the KNX installation and Fujitsu installation is OK. In case there is no communication activity between Intesis and the KNX side and/or Fujitsu units, check that those are operative: check communication cable used to connect all devices and any other communication parameter.

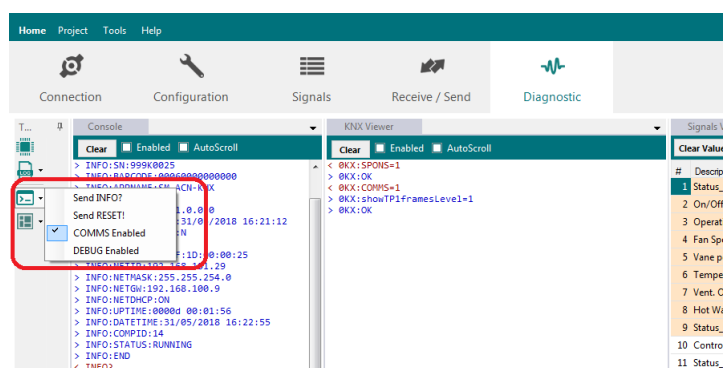

Figure 4.11 Enable COMMS

5 Electrical & Mechanical Features



Enclosure	Plastic, type PC (UL 94 V-0) Net dimensions (d×w×h): 90x88x56 mm Recommended space for installation (d×w×h): 130x100x100mm Color: Light Grey. RAL 7035	Battery	Size: Coin 20mm x 3.2mm Capacity: 3V / 225mAh Type: Manganese Dioxide Lithium
Mounting	Wall. DIN rail EN60715 TH35.	Console Port	Mini Type-B USB 2.0 compliant 1500VDC isolation
Terminal Wiring (for power supply and low-voltage signals)	Per terminal: solid wires or stranded wires (twisted or with ferrule) 1 core: 0.5mm ² ... 2.5mm ² 2 cores: 0.5mm ² ... 1.5mm ² 3 cores: not permitted	USB port	Type-A USB 2.0 compliant Only for USB flash storage device (USB pen drive) Power consumption limited to 150mA (HDD connection not allowed)
Power	1 x Plug-in screw terminal block (3 poles) 9 to 36VDC +/-10%, Max.: 140mA. 24VAC +/-10% 50-60Hz, Max.: 127mA Recommended: 24VDC	Push Button	Button A: Check the user manual Button B: Check the user manual
Ethernet	1 x Ethernet 10/100 Mbps RJ45 2 x Ethernet LED: port link and activity	Operation Temperature	0°C to +60°C
Port A	1 x KNX TP-1 Plug-in screw terminal block orange (2 poles) 2500VDC isolation from other ports KNX power consumption: 5mA Voltage rating: 29VDC 1 x Plug-in screw terminal block green (2 poles) Reserved for future use	Operational Humidity	5 to 95%, no condensation
Switch A (SWA)	1 x DIP-Switch for PORT A configuration: Reserved for future use	Protection	IP20 (IEC60529)
PORT B	1 x Serial EIA232 (SUB-D9 male connector) Reserved for future use 1 x Fujitsu Plug-in screw terminal block (3 poles) 1500VDC isolation from other ports	LED Indicators	10 x Onboard LED indicators 2 x Run (Power)/Error 2 x Ethernet Link/Speed 2 x Port A TX/RX 2 x Port B TX/RX 1 x Button A indicator 1 x Button B indicator
Switch B (SWB)	1 x DIP-Switch for PORT B configuration: Reserved for future use (leave OFF, default)		

6 Dimensions

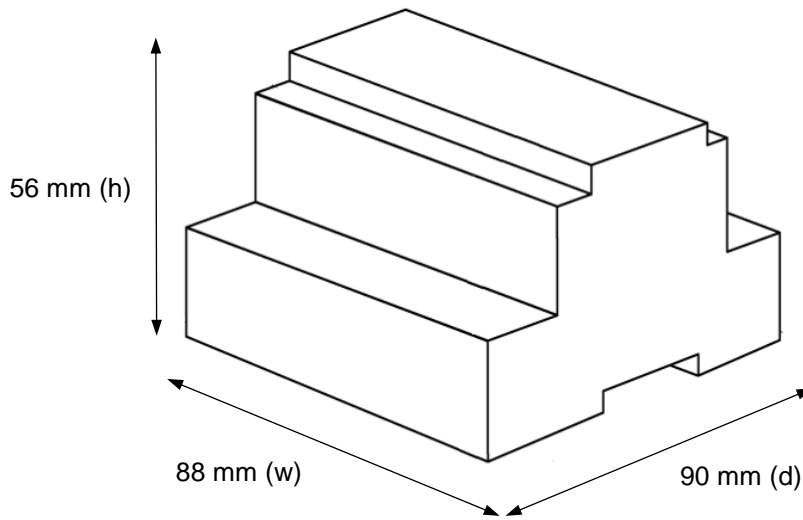

Recommended available space for its installation into a cabinet (wall or DIN rail mounting), with space enough for external connections

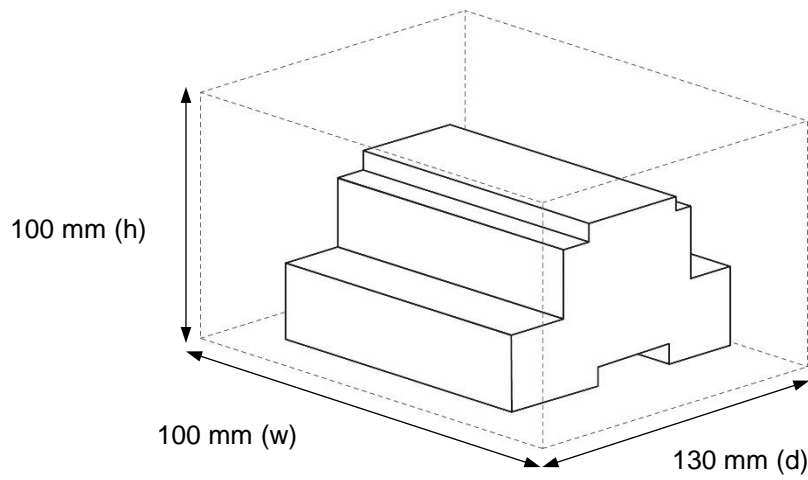

7 AC Unit Types compatibility

The gateway is compatible with Fujitsu VRF units after the VRF-II series (included).

8 Error codes for Indoor and Outdoor Units

Below you can find a list of error codes from Fujitsu air conditioning system.

V-II/J-II/VR-II Series

KNX Value	Error Code	Error Description
1	-	-
2	12	Remote controller communication error
3	13	Communication error between Outdoor unit
4	14	Network communication error
5	15	Scan error
6	16	Peripheral device communication error
7	21	Initial setting error
8	26	Address setting error
9	27	Master unit, slave unit set-up error
10	28	Other setting error
11	31	Indoor unit power supply abnormal
12	32	Indoor unit main PCB error
13	35	Manual auto switch error
14	37	Indoor unit transmission PCB error
15	38	Network convertor PCB error
16	41	Room temp. sensor error
17	42	Indoor unit Heat Ex. sensor error
18	51	Indoor unit fan motor1 error
19	53	Water Drain Abnormal
20	5U	Indoor unit error
21	61	Outdoor unit power supply abnormal
22	62	Outdoor unit main PCB error
23	63	Inverter PCB error
24	67	Short interruption detection protected operation
25	68	Magnetic relay error
26	69	Outdoor unit transmission PCB error
27	71	Discharge Temp Sensor Error
28	72	Compressor Temp Sensor Error
29	73	Outdoor unit Heat Ex. sensor error
30	74	Outdoor Temp Sensor Error
31	75	Suction Gas Temp Sensor Error
32	77	Heat sink temp. sensor error
33	82	Sub-cool Heat Ex. gas temp. sensor error
34	83	Liquid pipe temp. sensor error
35	84	Current sensor error
36	86	Pressure sensor error
37	92	Compressor 2 error
38	93	Compressor start up error
39	94	Trip detection
40	95	Compressor motor control error
41	97	Outdoor unit fan motor 1 error
42	99	4-way valve error
43	9U	Outdoor unit error
44	A1	Discharge temperature 1 abnormal
45	A2	Discharge temperature 2 abnormal
46	A3	Compressor temperature abnormal
47	A4	Pressure abnormal 1
48	A5	Pressure abnormal 2
49	AA	Special operation error

50	AC	Ambient temperature abnormal
51	C1	Main PCB error
52	C2	Transmission PCB error
53	C3	PCB 1 error
54	C4	PCB 2 error
55	C5	PCB 3 error
56	C6	PCB 4 error
57	C7	PCB 5 error
58	C8	Input device error
59	C9	Display device error
60	CA	EEPROM error
61	CC	Sensor error
62	CF	External connector error (USB memory)
63	CJ	Other parts error
64	-	Unknown
65	17	Electricity charge apportionment error
66	98	Outdoor unit fan motor 2 error
67	9A	Coil (Expansion Valve) error
68	52	Coil (Expansion Valve) error
69	J1	RB unit error
70	A6	Outdoor heat exchanger temperature abnormal
71	29	Connection unit number error in wired remote controller system
72	3A	Indoor unit communication circuit (wired remote controller) error

9 Appendix A – Communication Objects Table

TOPIC	NAME	LEN	DATAPOINT TYPE		FLAGS				FUNCTION
			DPT_NAME	DPT_ID	R	W	T	U	
GLOBAL SIGNALS	ENERGY SAVING	Control_Gateway ES	1 bit	DPT_Enable	1.003		W		0-Disable energy saving, 1-Enable energy saving
		Status_Gateway ES	1 bit	DPT_Enable	1.003	R		T	0-Disable energy saving, 1-Enable energy saving
	GATEWAY ERROR	Status_Gateway error	1 bit	DPT_Alarm	1.005	R		T	0-No error, 1-Error
		Status_Gateway error code	2 byte	Non-standarized	8.x	R		T	0-No Error, X-Error
	ON/OFF	On/Off (all units)	1 bit	DPT_Switch	1.001		W		0-Off, 1-On
	OP MODE	Operating Mode (all units)	1 byte	DPT_HVACContrMode	20.105		W		0-Auto, 1-Heat, 3-Cool, 9-Fan, 14-Dry
		Operating Mode (all units)	1 byte	Non-standarized	5.x		W		0-Auto, 1-Heat, 2-Dry, 3-Fan, 4-Cool
	FAN SPEED	Fan Speed (all units)	1 byte	Non-standarized	5.x		W		1-Quiet, 2-Low, 3-Med-Low, 4-Med-High, 5-High
		Fan Speed AUTO (all units)	1 bit	DPT_Switch	1.001		W		1-Set auto fan; 0-Stop auto fan
SETP TEMP	Temperature Setpoint (°C) (all units)	2 byte	DPT_Value_Temp	9.001		W		0..63.5 °C	
REMO.C.	Remote control disablement	1 bit	DPT_Bool	1.002		W		0-No disabled, 1-Disabled	
OUTDOOR UNIT SIGNALS	CAPACITY SAVE	Control_Capacity save	1 byte	DPT_Scaling	5.001		W		Thersholds (0%; 1%..40%; 41%..50%; 51%..60%; 61%..70%; 71%..80%; 81%..90%; 91%..100%)
		Status_Capacity save	1 byte	DPT_Scaling	5.001	R		T	Thersholds (0%; 40%; 50%; 60%; 70%; 80%; 90%; 100%)
	FORCE OFF	Control_Forced off	1 bit	DPT_Bool	1.002		W		0-Not forced, 1-Forced off
		Status_Forced off	1 bit	DPT_Bool	1.002	R		T	0-Not forced, 1-Forced off
	ERROR	Status_Error	1 bit	DPT_Alarm	1.005	R		T	0-No error, 1-Error
Status_Error code		2 byte	Non-standarized	8.x	R		T	0-No Error, X-Error	
EXISTES	EXISTES	Status_Exists	1 bit	DPT_Switch	1.001	R		T	0-Not exist,1-Exists
	ON / OFF	Control_On/Off	1 bit	DPT_Switch	1.001		W		0-Off,1-On
		Status_On/Off	1 bit	DPT_Switch	1.001	R		T	0-Off,1-On
	OP MODE	Control_Operation mode	1 byte	DPT_HVACContrMode	20.105		W		0-Auto, 1-Heat, 3-Cool, 9-Fan, 14-Dry
		Status_Operation mode	1 byte	DPT_HVACContrMode	20.105	R		T	0-Auto, 1-Heat, 3-Cool, 9-Fan, 14-Dry
		Control_Operation mode	1 byte	Non-standarized	5.x		W		0-Auto, 1-Heat, 2-Dry, 3-Fan, 4-Cool

INDOOR UNIT SIGNALS	Status _Operation mode	1 byte	Non-standarized	5.x	R		T	0-Auto, 1-Heat, 2-Dry, 3-Fan, 4-Cool	
	Control _Mode Cool/Heat	1 bit	DPT_Heat/Cool	1.100		W		0-Cool, 1-Heat	
	Status _Mode Cool/Heat	1 bit	DPT_Heat/Cool	1.100	R		T	0-Cool, 1-Heat	
	Control _Heat mode&ON	1 byte	DPT_Scaling	5.001		W		0%-Off, 1%-100%-On+Heat	
	Control _Cool mode&ON	1 byte	DPT_Scaling	5.001		W		0%-Off, 1%-100%-On+Cool	
	Control _Auto mode	1 bit	DPT_Switch	1.001		W		1-Set auto mode	
	Status _Auto mode	1 bit	DPT_Switch	1.001	R		T	1-Auto mode active, 0-Auto mode not active	
	Control _Heat mode	1 bit	DPT_Switch	1.001		W		1-Set heat mode	
	Status _Heat mode	1 bit	DPT_Switch	1.001	R		T	1-Heat mode active, 0-Heat mode not active	
	Control _Cool mode	1 bit	DPT_Switch	1.001		W		1-Set cool mode	
	Status _Cool mode	1 bit	DPT_Switch	1.001	R		T	1-Cool mode active, 0-Cool mode not active	
	Control _Fan mode	1 bit	DPT_Switch	1.001		W		1-Set fan mode	
	Status _Fan mode	1 bit	DPT_Switch	1.001	R		T	1-Fan mode active, 0-Fan mode not active	
	Control _Dry mode	1 bit	DPT_Switch	1.001		W		1-Set dry mode	
	Status _Dry mode	1 bit	DPT_Switch	1.001	R		T	1-Dry mode active, 0-Dry mode not active	
	FAN SPEED	Control_Fan speed enumerated	1 byte	Non-standarized	5.x		W		1-Quiet, 2-Low, 3-Med, 4-High
		Status _Fan speed enumerated	1 byte	Non-standarized	5.x	R		T	1-Quiet, 2-Low, 3-Med, 4-High
		Control _Fan speed scaling	1 byte	DPT_Scaling	5.001		W		Thersholds (0%..37%; 38%..62%; 63%..87%; 88%..100%)
		Status _Fan speed scaling	1 byte	DPT_Scaling	5.001	R		T	Thersholds (25%; 50%; 75%; 100%)
		Control_Fan speed enumerated	1 byte	Non-standarized	5.x		W		1-Quiet, 2-Low, 3-Med-Low, 4-Med-High, 5-High
		Status _Fan speed enumerated	1 byte	Non-standarized	5.x	R		T	1-Quiet, 2-Low, 3-Med-Low, 4-Med-High, 5-High
		Control _Fan speed scaling	1 byte	DPT_Scaling	5.001		W		Thersholds (0%..29%; 30%..49%; 50%..69%; 70%..89%; 90%..100%)
		Status _Fan speed scaling	1 byte	DPT_Scaling	5.001	R		T	Thersholds (20%; 40%; 60%; 80%; 100%)
		Control_ Fan speed low	1 bit	DPT_Switch	1.001		W		1-Set fan speed low
Status_Fan speed low		1 bit	DPT_Switch	1.001	R		T	1-Speed low active, 0-Speed low not active	
Control_ Fan speed med-low		1 bit	DPT_Switch	1.001		W		1-Set fan speed med-low	
Status_Fan speed med-low		1 bit	DPT_Switch	1.001	R		T	1-Speed med-low active, 0-Speed med-low not active	
Control_Fan speed med	1 bit	DPT_Switch	1.001		W		1-Set fan speed med		

INDOOR UNIT SIGNALS		Status_Fan speed med	1 bit	DPT_Switch	1.001	R		T	1-Speed med active, 0-Speed med not active
		Control_Fan speed med-high	1 bit	DPT_Switch	1.001		W		1-Set fan speed med-high
		Status_Fan speed med-high	1 bit	DPT_Switch	1.001	R		T	1-Speed med-high active, 0-Speed med-high not active
		Control_Fan speed high	1 bit	DPT_Switch	1.001		W		1-Set fan speed high
		Status_Fan speed high	1 bit	DPT_Switch	1.001	R		T	1-Speed high active, 0-Speed high not active
		Control_Fan speed quiet	1 bit	DPT_Switch	1.001		W		1-Set fan speed quiet
		Status_Fan speed quiet	1 bit	DPT_Switch	1.001	R		T	1-Speed quiet active, 0-Speed quiet not active
		Control_Fan speed Man/Auto	1 bit	DPT_Switch	1.001		W		0-Manual; 1-Auto
		Status_Fan speed Man/Auto	1 bit	DPT_Switch	1.001	R		T	0-Manual; 1-Auto
	VANE POS	Control_Vanes UD enumerated	1 byte	Non-standarized	5.x		W		1-Position 1..4-Position 4
		Status_Vanes UD enumerated	1 byte	Non-standarized	5.x	R		T	1-Position 1..4-Position 4
		Control_Vanes UD scaling	1 byte	DPT_Scaling	5.001		W		Thersholds (0%..37%; 38%..62%; 63%..87%; 88%..100%)
		Status_Vanes UD scaling	1 byte	DPT_Scaling	5.001	R		T	Thersholds (25%; 50%; 75%; 100%)
		Control_Vanes UD pos-1	1 bit	DPT_Switch	1.001	R		T	1-Set position-1 vanes
		Status_Vanes UD pos-1	1 bit	DPT_Switch	1.001		W		1-Vane position-1 active, 0-Vane position-1 not active
		Control_Vanes UD pos-2	1 bit	DPT_Switch	1.001	R		T	1-Set position-2 vanes
		Status_Vanes UD pos-2	1 bit	DPT_Switch	1.001		W		1-Vane position-2 active, 0-Vane position-2 not active
		Control_Vanes UD pos-3	1 bit	DPT_Switch	1.001	R		T	1-Set position-3 vanes
		Status_Vanes UD pos-3	1 bit	DPT_Switch	1.001		W		1-Vane position-3 active, 0-Vane position-3 not active
		Control_Vanes UD pos-4	1 bit	DPT_Switch	1.001	R		T	1-Set position-4 vanes
		Status_Vanes UD pos-4	1 bit	DPT_Switch	1.001		W		1-Vane position-4 active, 0-Vane position-4 not active
		Control_Vanes UD swing	1 bit	DPT_Switch	1.001	R		T	0-Swing off; 1-Swing on
		Status_Vanes UD swing	1 bit	DPT_Switch	1.001		W		0-Swing off; 1-Swing on
		Control_Vanes LR enumerated	1 byte	Non-standarized	5.x		W		1-Position 1..5-Position 5
		Status_Vanes LR enumerated	1 byte	Non-standarized	5.x	R		T	1-Position 1..5-Position 5
		Control_Vanes LR scaling	1 byte	DPT_Scaling	5.001		W		Thersholds (0%..29%; 30%..49%; 50%..69%; 70%..89%; 90%..100%)
Status_Vanes LR scaling	1 byte	DPT_Scaling	5.001	R		T	Thersholds (20%; 40%; 60%; 80%; 100%)		
Control_Vanes LR pos-1	1 bit	DPT_Switch	1.001	R		T	1-Set position-1 vanes		

INDOOR UNIT SIGNALS		Status_Vanes LR pos-1	1 bit	DPT_Switch	1.001		W		1-Vane position-1 active, 0-Vane position-1 not active	
		Control_Vanes LR pos-2	1 bit	DPT_Switch	1.001	R		T	1-Set position-2 vanes	
		Status_Vanes LR pos-2	1 bit	DPT_Switch	1.001		W		1-Vane position-2 active, 0-Vane position-2 not active	
		Control_Vanes LR pos-3	1 bit	DPT_Switch	1.001	R		T	1-Set position-3 vanes	
		Status_Vanes LR pos-3	1 bit	DPT_Switch	1.001		W		1-Vane position-3 active, 0-Vane position-3 not active	
		Control_Vanes LR pos-4	1 bit	DPT_Switch	1.001	R		T	1-Set position-4 vanes	
		Status_Vanes LR pos-4	1 bit	DPT_Switch	1.001		W		1-Vane position-4 active, 0-Vane position-4 not active	
		Control_Vanes LR pos-5	1 bit	DPT_Switch	1.001	R		T	1-Set position-5 vanes	
		Status_Vanes LR pos-5	1 bit	DPT_Switch	1.001		W		1-Vane position-5 active, 0-Vane position-5 not active	
		Control_Vanes LR swing	1 bit	DPT_Switch	1.001	R		T	0-Swing off; 1-Swing on	
		Status_Vanes LR swing	1 bit	DPT_Switch	1.001		W		0-Swing off; 1-Swing on	
		TEMPERATURES	Control_Temperature Setpoint (°C)	2 byte	DPT_Value_Temp	9.001		W		0..63.5 °C
			Status_Temperature Setpoint (°C)	2 byte	DPT_Value_Temp	9.001	R		T	0..63.5 °C
			Status_AC Ambient Temperature (°C)	2 byte	DPT_Value_Temp	9.001	R		T	0..63.5 °C
			Control_KNX ambient Temperature (°C)	2 byte	DPT_Value_Temp	9.001		W		°C
		ERROR CODE	Status_Unit error	1 bit	DPT_Alarm	1.005	R		T	0-No error, 1-Error
			Status_Unit error code	2 byte	Non-standardized	8.x	R		T	0-No Error, X-Error
		EMERGENCY	Status_Emergency	1 bit	DPT_Switch	1.001	R		T	0-Off, 1-On
		FILTER	Status_FilterSign	1 bit	DPT_Alarm	1.005	R		T	0-Normal, 1-Alarm
			Control_FilterReset	1 bit	DPT_Reset	1.015		W		0-No reset, 1-Reset
		REMOC.	Control_Remote controll disablement (all)	1 bit	DPT_Bool	1.002		W		0-No disabled, 1-Disabled
			Status_Remote controll disablement (all)	1 bit	DPT_Bool	1.002	R		T	0-No disabled, 1-Disabled
			Control_On/Off Remote controll disablement	1 bit	DPT_Bool	1.002		W		0-No disabled, 1-Disabled
			Status_On/Off Remote controll disablement	1 bit	DPT_Bool	1.002	R		T	0-No disabled, 1-Disabled
			Control_Mode Remote controll disablement	1 bit	DPT_Bool	1.002		W		0-No disabled, 1-Disabled

		<i>Status_Mode Remote controll disablement</i>	<i>1 bit</i>	<i>DPT_Bool</i>	<i>1.002</i>	<i>R</i>		<i>T</i>	<i>0-No disabled, 1-Disabled</i>
		<i>Control_Setpoint Remote controll disablement</i>	<i>1 bit</i>	<i>DPT_Bool</i>	<i>1.002</i>		<i>W</i>		<i>0-No disabled, 1-Disabled</i>
		<i>Status_Setpoint Remote controll disablement</i>	<i>1 bit</i>	<i>DPT_Bool</i>	<i>1.002</i>	<i>R</i>		<i>T</i>	<i>0-No disabled, 1-Disabled</i>
	OTHERS	<i>Control_Thermostat off</i>	<i>1 bit</i>	<i>DPT_Switch</i>	<i>1.001</i>		<i>W</i>		<i>0-Thermostat on, 1-Thermostat off</i>
		<i>Status_Thermostat off</i>	<i>1 bit</i>	<i>DPT_Switch</i>	<i>1.001</i>	<i>R</i>		<i>T</i>	<i>0-Thermostat on, 1-Thermostat off</i>