



WS1000 Connect

Building control system

Article numbers 60241-60246



elsner

Installation, setting, operation

1. Description	7
1.1. Area/field of application	8
Overview of connection and control options	10
Scope of delivery	10
Automatic functions of the motors and devices	10
1.1.1. Technical Data, central unit WS1000 Connect	14
2. Operation	15
2.1. Start page	16
2.1.1. Weather data display	17
2.2. The touch display	19
2.3. Operate motors and devices manually	19
2.3.1. The manual menu	19
Examples of manual pages	20
Key functions and display fields	21
Info icons	23
2.3.2. External keys	26
2.3.3. Internal keys (group keys)	26
2.3.4. Remote control	26
2.3.5. WS1000 Connect App	27
2.3.6. Navigate in the system menu	28
2.4. Internet (browser)	29
2.5. Slide show	30
3. Automatic	31
3.1. Set-up automatic	32
3.1.1. Safety notice for automatic and alarm functions	33
Power failure, maintenance works, etc. (restart of control)	33
3.2. Adjust general automatic settings	34
3.2.1. Change twilight	34
3.2.2. Change travel delay (shades)	34
3.2.3. Set timer	34
3.2.4. Adjust ventilation lock (air-conditioning unit)	35
3.2.5. Set night back cooling (ventilation)	35
3.2.6. Adjust frost alarm	36
3.2.7. Set movement limit (windows)	37
3.2.8. Set wind delay (shades)	37
3.2.9. Specify automatic reset	38
3.3. Set automatic for motors and devices	38
3.3.1. Motors and devices without automatic functions	38
3.3.2. Set automatic sun protection	38

Alarm functions	39
Shade settings	39
Set-up automatic	39
3.3.3. Set automatic window controls	45
Alarm functions	45
Ventilation settings	46
Set-up automatic	46
3.3.4. Set automatic ventilation	51
Alarm functions	51
Ventilation settings	52
Set-up automatic	52
Ventilation modes, radio roof fan	56
3.3.5. Set automatic heating	56
3.3.6. Set automatic air-conditioning	57
3.3.7. Set automatic light controls	59
3.3.8. Set automatic gutter heating	59
3.3.9. Set alarm	60
Alarm output	60
Set motion detector	60

4. Installation and commissioning 63

4.1. Procedure	64
4.1.1. Operating system	64
4.1.2. Protective film	64
4.1.3. Installation notes	64
4.1.4. Notes on wireless equipment	65
4.1.5. Safety notice for automatic and alarm functions	65
Power failure, maintenance works, etc. (restart of control)	66
4.1.6. Installation of the weather station: see leaflet	66
4.2. Installation of the indoor sensor: see leaflet	66
4.3. Installation of the Control System: see leaflet	66
4.3.1. Connect motors and devices	66
Connect motor groups	66
Connect device to multifunction outputs	67
Connect device to multifunction inputs	67
Connect hand button	68
Connect motors and devices wirelessly with the Control System	68
4.3.2. Start Control System	69
4.3.3. Check function of the sensors	69

5. Basic setting 71

5.1. The "Installation" menu	72
5.1.1. Set motors and motor groups	73
Tips on connecting windows	76

5.1.2. Set multifunction outputs	76
5.1.3. Set multifunction inputs	77
5.1.4. Wireless connections	78
5.1.5. Allocate external keys	85
5.1.6. Allocate internal keys (group keys)	86
5.1.7. Scenes	87
5.1.8. Start page	87
5.1.9. Manual page	88
5.1.10. Weather display	89
5.1.11. Presence simulation	90
5.2. Set up WS1000	91
5.2.1. Settings	92
Enter time and date manually	92
Change language	92
Set up screen	92
Switch key tone off/on	94
Select time zone	94
Enter location	94
5.2.2. Service settings	94
Cleaning mode	94
Reset (restart)	95
Factory settings	95
Internal area	95
Remote set up/remote maintenance	95
5.2.3. Access code	96
5.2.4. Using an SD card	97
Save and load configuration data	97
Show pictures on the display	98
Internet	99
Device information	100

6. Tables, plans, maintenance 101

6.1. Maintenance and care	102
Maintenance of the weather station	102
Maintenance of the Control System	102
6.2. Units for sun and wind	103
6.3. Disposal	104
6.4. Alarm and error messages	104
Network error	104
Alarm display in the weather data area	105
Smoke alarm	106
Weather station errors	107
6.5. Wiring diagrams	108
Connection examples for multifunction outputs	112

6.6. Personal automatic settings data	113
--	------------

This manual is amended periodically and will be brought into line with new software releases. The change status (software version and date) can be found in the contents footer. If you have a device with a later software version, please check **www.elsner-elektronik.de** in the menu area "Service" to find out whether a more up-to-date version of the manual is available.

Clarification of signs used in this manual



Safety advice.



Safety advice for working on electrical connections, components, etc.

DANGER!

... indicates an immediately hazardous situation which will lead to death or severe injuries if it is not avoided.

WARNING!

... indicates a potentially hazardous situation which may lead to death or severe injuries if it is not avoided.

CAUTION!

... indicates a potentially hazardous situation which may lead to trivial or minor injuries if it is not avoided.



ATTENTION! ... indicates a situation which may lead to damage to property if it is not avoided.



"Control unit"

The symbol is followed by a menu path. In this menu the settings just described can be changed.



"Manual"

The symbol is followed by chapter information with a page number. In this chapter you will find additional information about the setting just described.

1. Description

1.1. Area/field of application

The various technical facilities installed in the building are controlled automatically and operated manually using the **WS1000 Connect Control System**. In order to be able to set up the system flexibly, both cable connections and wireless channels are available.

The **WS1000 Connect** is delivered as a set, which includes the sensors needed for room climate and weather data as well as the central unit (display with control electronics). The sensor values are shown in the display and are the basis of the automatic controls.

Functions and properties of the central unit WS1000 Connect:

- **Colour touch display** 10.1 inch, for manual operation, system set up and for setting the basic and automatic functions
- **Network connection** by LAN or WLAN
- **Browser** for viewing websites, etc.
- **Remote access** via network for system setup, diagnostics etc. Approval by the user required
- Slide show from SD card as screen saver
- Data storage on SD card (storage of settings)
- Integrated loudspeaker (4 tweeters, 1 broadband speaker)
- Individually settable **presence simulation**
- **Motor outputs** (4-10 pcs, depending on model) for electrically powered
 - Awnings, blinds, shutters
 - Windows/sliding roofs
- **4 multifunction outputs** for
 - Lights (on/off)
 - Dimmer of one light
 - Heating (on/off), cooling (on/off), ventilators (on/off)
 - Alarms
 - Gutter heating
- **16 scenes** for calling individually set movement positions and switch states
With a scene, several motors and devices are addressed simultaneously so a suitable ambience is created with one press of a button ("TV", "Eating", etc.).
- **4 multifunction inputs** for
 - Motion detector
 - Smoke detector
 - Climate detector (prevent ventilation if external air-conditioning/heating is active)
 - Safety contact (motors in safe position, prevent exhaust air, start incoming air)
 - Impulse for automatic reset
 - Binary contact for free use
- **10 key inputs** for additional conventional wind sensor for operating motors and devices on site
- **32 radio channels** for devices with Elsner RF radio protocol
 - Sensors WGTH-UP for room temperature, humidity (from version 1.3),

- WG AQS/TH-UP for room temperature, humidity, CO₂,
WGT (indoor temperature) for measuring at other locations in the room
- Remote control Remo 8 (from version 1.8), Remo pro
 - Sensor Corlo P RF, sensor interface RF-B2-UP
 - WL400, WL800 and WL-Z ventilation units
 - RF-VM ventilation module for connecting fans/circulation air heaters from other manufacturers
 - Wireless relay RF relay for on/off (each from version 5.5), Heating module RF-HE-ST (from version 5)
 - Wireless motor control device RF-MSG for up/down (from version 3.7)
 - RF-L wireless dimmer:

The wireless actuators with a production date after 14.01.2016 are compatible with the **WS1000 Connect** system. The production date can be found as part of the serial number which has the following structure "DD MM YY consecutive number".

**WARNING!**

The radio transmission takes place over a non-exclusively available transmission channel!

The device is not suited for applications outside the field of safety equipment, such as emergency stop and alarm equipment.

Functions and properties of the indoor sensor:

- Temperature measurement
- Humidity measurement

Functions and properties of the weather station:

- Brightness measurement (sun sensor)
- Temperature measurement
- Wind speed measurement
- Precipitation detection
- GPS receiver for date/time and installation coordinates (for sun position calculation)

Overview of connection and control options

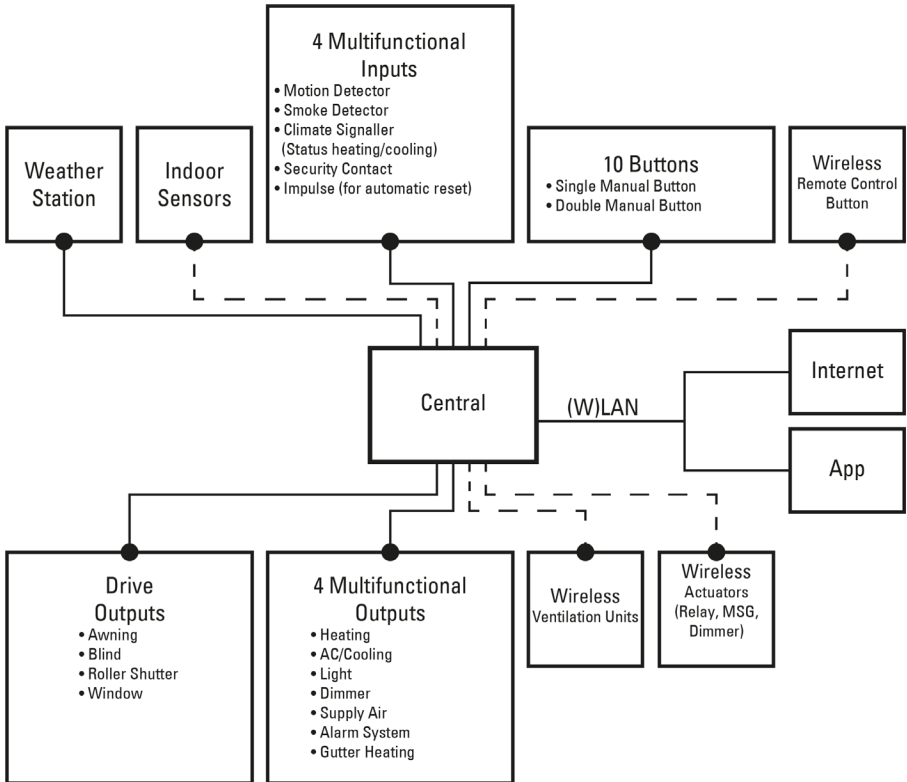

Scope of delivery

- Central control and operating unit with flush installation box and installation accessories
- SD card in card slot
- Weather station with connection accessories
- Indoor sensor with frame
(In addition, you need a device socket \varnothing 60 mm, 42 mm deep)

Automatic functions of the motors and devices

Devices (e.g. lights) connected via the **"Dimming" output** do not have automatic functions. However, they can be operated manually via the display.

Automatic functions for windows/sliding roofs:

- Open from a selectable indoor temperature (can be switched off)
- Open from a selectable humidity in the room (can be switched off)
- Open according to the CO₂ content of the room (only with CO₂ sensor, can be switched off)
- Close if the incoming air temperature is higher than the room temperature (can be switched off)
- Night back cooling (period can be set)
- Daily force ventilation (period can be set)
- Outside temperature block: Block below a selectable outside temperature (can be switched off)
- Keep closed in a settable period
- Frost alarm: Close during precipitation below a selectable outside temperature (can be switched off)
- Wind alarm: Close if a selectable wind speed is exceeded (can be switched off)
- Rain alarm: Close completely or to only provide a gap during rainfall (can be switched off)
- Close if the cooling/air-conditioning is active

If a motion sensor is connected, windows are closed automatically if there is a burglary alarm. If a smoke detector is connected, windows are closed automatically if there is a fire alarm.

Step windows are opened gradually. An opening position can be selected for sliding windows.

Automatic functions for awnings:

- Extend depending on brightness and sun position
or retract irrespective of brightness (extension only manual)
or extend irrespective of brightness (privacy protection, automatic retraction only if there is a rain or wind alarm)
- Movement position can be set
- Retract until a selectable indoor temperature is reached (can be switched off)
- Outside temperature block: Block below a selectable outside temperature (can be switched off)
- Frost alarm: Retract during precipitation below a selectable outside temperature (can be switched off)
- Wind alarm: Retract if a selectable wind speed is exceeded (can be switched off)
- Rain alarm: Retract during rainfall (can be switched off)

If a smoke detector is connected, awnings are retracted automatically if there is a fire alarm.

Automatic functions for blinds:

- Close depending on brightness and sun position
or keep open irrespective of brightness (closing only time-controlled or

manual)

or keep closed irrespective of brightness (privacy protection, automatic retraction only if there is a rain or wind alarm) with reversal in order to let in light

- Movement position and blind position can be set (slat adjustment possible according to sun height)
- Keep open until a selectable indoor temperature is reached (can be switched off)
- Close at night/twilight (can be switched off)
- Close daily (period can be set)
- Outside temperature block: Block below a selectable outside temperature (can be switched off)
- Frost alarm: Retract during precipitation below a selectable outside temperature (can be switched off)
- Wind alarm: Retract if a selectable wind speed is exceeded (can be switched off)
- Rain alarm: Retract during rainfall (can be switched off)

If a smoke detector is connected, blinds are closed automatically if there is a fire alarm.

Automatic functions for shutters:

- Close depending on brightness and sun position
or keep open irrespective of brightness (closing only time-controlled or manual)
or keep closed irrespective of brightness (privacy protection, automatic retraction only if there is a rain or wind alarm)
- Movement position can be set
- Keep open until a selectable indoor temperature is reached (can be switched off)
- Close at night/twilight (can be switched off)
- Close daily (period can be set)
- Outside temperature block: Block below a selectable outside temperature (can be switched off)
- Frost alarm: Retract during precipitation below a selectable outside temperature (can be switched off)
- Wind alarm: Retract if a selectable wind speed is exceeded (can be switched off)
- Rain alarm: Retract during rainfall (can be switched off)

If a smoke detector is connected, shutters are closed automatically if there is a fire alarm.

Automatic functions for heating:

- Switch on during the day below a selectable indoor temperature
- Lowering at night (period and temperature can be set, to which it should be lowered)

If a smoke detector is connected, the heating switches off automatically if there is a smoke alarm.

Automatic functions for cooling and air-conditioners:

- Switch off during the day below a selectable indoor temperature
- Night mode (period and temperature can be set, to which it should be cooled)
- Prevent ventilation if cooling/air-conditioning is active

If a smoke detector is connected, the cooling switches off automatically if there is a smoke alarm.

Automatic functions for ventilation:

- Ventilation from a selectable indoor temperature (can be switched off)
- Ventilate from a selectable air humidity in the room (can be switched off)
- Ventilation according to the CO₂ content of the room (only with CO₂ sensor, can be switched off)
- Winter switching: Incoming air is closed below a selectable outside temperature (can be switched off)
- Summer switching: Incoming air is closed if the outside temperature is higher than the room temperature.
- Minimum and maximum speed of motorised fans can be set
- Night back cooling (period can be set)
- Daily force ventilation (period can be set)
- For roof ventilators WL400/800 also: Circulating air for heat recovery; circulating air for preventing condensation
- Prevent ventilation if cooling/air-conditioning is active

If a smoke detector is fitted, the ventilation is activated automatically if there is a fire alarm.

Automatic functions for light:

- Switch on daily (period can be set, with and without twilight detection)
- Switch on at twilight
- Switch on if there is an alarm (motion/smoke detector)

Automatic functions for gutter heating:

- Switch on within a settable temperature range

Automatic alarms:

- Motion detector: Period when alarm is active can be set. If the alarm is triggered during this period, all windows close. Normal automatic mode is restored after 5 minutes if there is no new alarm signal
- Smoke detector: If there is an alarm, shades retract (escape routes), windows open, fans open/switch on (smoke removal) and heating and air-conditioning

switch off. Manual operation is not possible. An acoustic warning signal is issued by the control

Presence simulation:

- Sequence of up to 16 events (e.g. switch on light, move blind, etc.)
- Event start at a specific time with or without random delay

1.1.1. Technical Data, central unit WS1000 Connect

Housing	Glass, plastic
Colour	black
Assembly	Flush / cavity wall
Degree of protection	IP 20
Dimensions	Display front approx. 279 x 185 (W x H, mm), Installation depth approx. 29 mm, Concealed box approx. 254 x 171 x 85 (W x H x D, mm)
Display resolution	1280 x 800 px
Weight	approx. 2.2 kg for model WS1000 Connect-10
Ambient temperature	Operation 0...+45°C, Storage -30...+70°C
Ambient humidity	5...95% RH, avoid condensation
Operating voltage	230V AC, 50 Hz
Power consumption	Readiness max. 17 W
Load capacity Motor outputs	<u>230 V outputs:</u> per motor output, max. 400 W, total max. 1.5 kW <u>Potential-free outputs (PF model):</u> per motor output max. 5 A / 230 V
Radio frequency radio channels	868.2 MHz (Elsner RF).
WLAN frequency band	2.4 GHz and 5 GHz
Loudspeaker	integrated
Moving parts	none (fanless)

The product is compliant with the provisions of EU Directives.

2. Operation

2.1. Start page

With the **WS1000 Connect Control System** you can control the connected technology centrally, e.g. raise and lower shades, switch devices on and off and dim lights. All the settings are also made on the display.

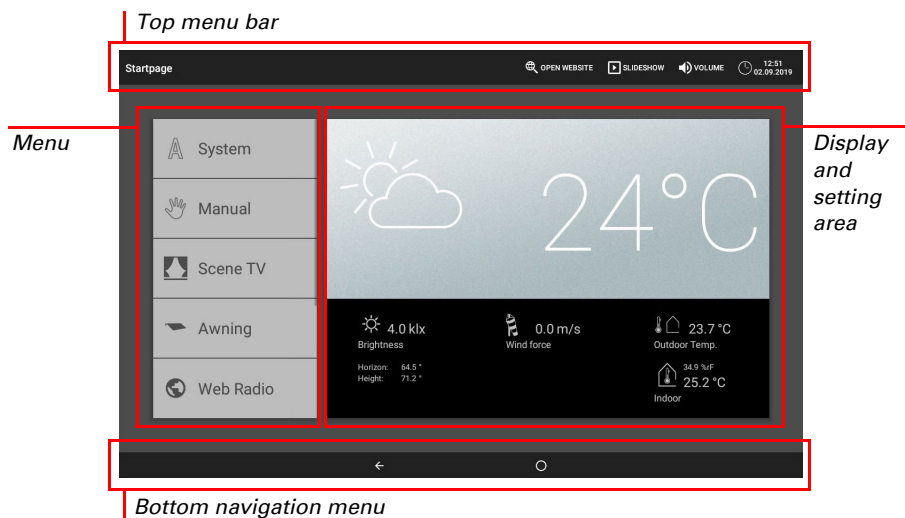

Top menu bar:

The Internet browser (*open website*) and *Volume* functions can be accessed at any time via the top menu bar. Time and date are displayed. Additionally, the start key for the slide show appears here as soon as an SD card with pictures is loaded.

Menu on left (Start menu):

The menu on the left-hand side contains the *System* menu, with which you can reach all the basic and automatic settings.

Connected motors and devices are operated by hand using the *Manual* menu.

The menu item *Presence simulation* is displayed in the start menu depending on the setting. The *presence simulation* can be switched on or off there.

This includes the selected *Favourites* for manual operation and the websites saved as *Bookmarks*.

So that a motor/device is displayed in the Manual menu and/or as a Favourite, the display has to be activated in the setting "Manual menu" in the installation settings.

☐ System > Installation > Motor/Multif.output > Manual menu

Right-hand display and settings area:

The control unit displays the current *weather data* as its start page .

The functions / parameters are displayed here when navigating in the settings (sub-menus).

Bottom navigation menu:

On the **bottom edge of the display** you will see a **Navigation menu** with "Back" arrow and a circle, which takes you back directly to the start page. Stay longer on the circle to activate the screen saver.

2.1.1. Weather data display

The current weather and indoor data is displayed in the large display area on the right.

General weather symbol and outside temperature:**Sunny or cloudy****Rain**

If there is a rain message and there are temperatures above -3 °C it is raining

Snow

If there is a rain message and there are temperatures below -3 °C it is snowing.

Night**Sun data:**

Light intensity: Brightness in lux (lx) or kilolux (klx)

Direction: Compass direction (azimuth) in degrees

Height: Elevation above the horizon in degrees

Wind:

The wind speed is displayed in metres per second (m/s) and the windssock changes:



Calm: up to 1.9 m/s



Weak wind: 2.0 to 9.9 m/s



Strong wind: from 10.0 m/s



If a wind alarm has been triggered for a motor, a warning is displayed next to the wind symbol.

Outside temperature:

Outside temperature at the weather station in degrees Celsius (°C)

For the outside temperature value, **night back cooling**, **frost alarm** and **window movement limit** are shown alternately as soon as the corresponding function is active.

 3.3. Set night back cooling (ventilation)

 3.3. Adjust frost alarm

 3.3. Set movement limit (windows)

Indoor data:



Temperatures in degrees Celsius (°C)
Humidity in %rF

You can set which indoor data should be displayed (e..g. if several sensors are connected).

- System > Installation > Weather display
-  6.1. Indoor sensor for weather data display

2.2. The touch display

The manual controls and the default setting of the automatic functions are performed via the permanently installed touch display of the Control System. The button surfaces are actuated by pressing the display in the respective area. If a key is pressed, there is optical feedback and a brief audio signal is emitted. The key tone can be switched off.

- System > Set up WS1000 > Settings > Key tone
-  5.2.1. Settings > Switch key tone off/on, Page 94

Operating the display with long fingernails will not damage the display screen or the touch function. Touching with very hard and pointed objects (e.g. made from glass, gemstone or metal) should be avoided because this can cause scratches.

2.3. Operate motors and devices manually

The start menu is on the left of the start page. Beneath the system and manual menu key, selected **favourites** are displayed for the manual operations and the websites saved as bookmarks. So that a motor/device is displayed in as a favourite, the display has to be activated in the setting "Manual menu" in the installation settings.

You can change the display sequence in the start menu:

- System > Installation > Start page
-  5.1.8. Start page

2.3.1. The manual menu

- Start menu > Manual

The page for manual operation is reached via the **Manual menu** key on the start page.

So that a motor/device is displayed here, the display has to be activated in the setting "Manual menu" in the installation settings. Either individual motors/devices and group keys are displayed, or subject groups.

A **group key** summarises a motor or device with the same function (e.g. all blinds in a room). These motors/devices are operated simultaneously with the key.

-  5.1.6. Allocate internal keys (group keys), Page 86

Different functions are collated in a **subject group** in order to create more overview in the manual menu. The following groups are available:

- Central function: for group keys and scenes
- All visible functions: all functions, not selection possible
- Room control: for heating, air-conditioning and fans
- Floors: for different floors in a building
- Output for motors and devices
- Input: for sensors

You can change the display sequence in the manual menu here:

- System > Installation > Manual page
-  Building on automatic:, Page 88



As soon as a subject group has been activated, motors and devices are no longer displayed in the manual menu!

Examples of manual pages

Blinds in automatic mode:

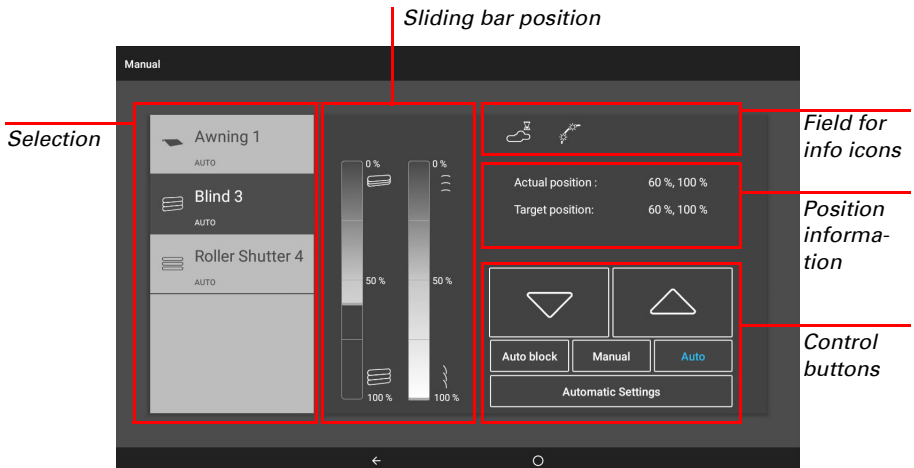

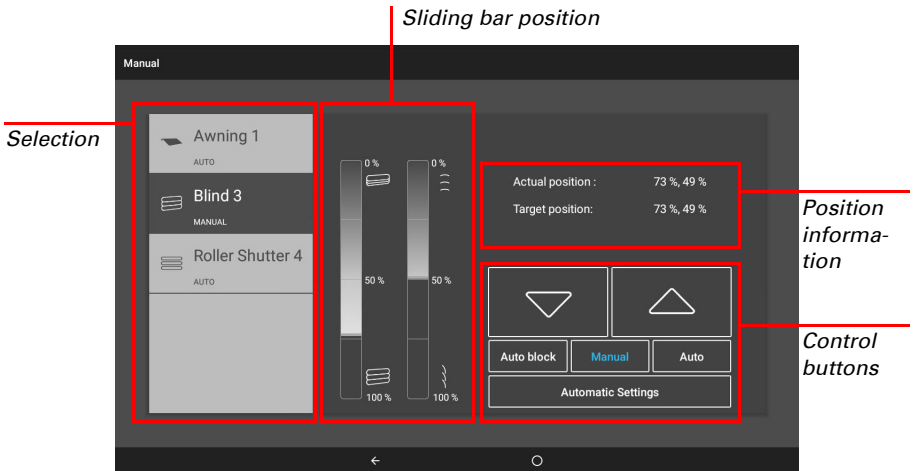
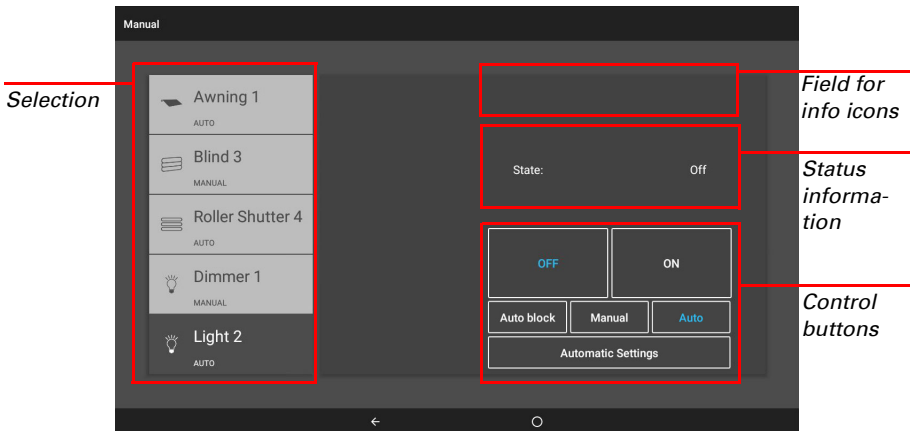
Blind after manual movement:**Switch lights to automatic mode:****Key functions and display fields****Up/down keys:**

The keys **Up** and **Down** have a timer automatic.

A **motor** can be precisely positioned by briefly pressing it (less than 1 second, short audio signal). For blinds and shutters, only a brief step movement command is issued. If the key is held for more than 1 second (higher audio signal: state signal), the motor moves automatically to the end position. Brief pressing of the opposite direction stops the motor.

For shades and windows, the movement position is shown in percent above the Up-/Down buttons (for blinds, also the slat position). For radio motor control units, the position shown can deviate from the movement position set in the automatic mode by up to 2%.

Ventilators WL400 and WL800 are switched by briefly pressing (less than 1 second, short audio signal) in 10%-steps (total of 10 ventilation steps). Pressing a key for longer continuously changes the speed. If the key is released, the change in speed stops. The ventilation is switched off by pressing the stop button.

In rare cases, the speed continues to change after the key has been released because of radio problems. The please press the opposite direction briefly.

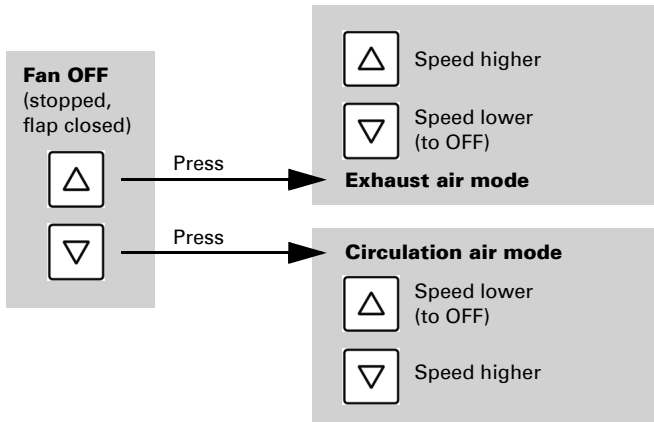

Each time the **OFF** state is reached, the speed change stops automatically, so that a direct change between exhaust and circulation modes is impossible.

Automatic block/Manual/Automatic:

Whether a motor or device is in automatic mode or has been operated manually, can be detected from the blue marking on the key and the text in the list on the left. You can switch mode by pressing a key.

After any manual operation, the drive or unit remains in manual mode. The automatic functions are then switched off, only rain and wind protection are executed. The respective automatic mode can be reactivated by hand ("Auto" button) or for all motors and devices (Building on automatic:, Page 88). In addition, an automatic reset can be activated in the automatic settings of each motor group and each device, both at a fixed

time and after a manual operation. You can access these and other settings of a drive/unit directly with the "Automatic Settings" button.

Pressing the "Auto block" button deactivates the automatic system (blue button font). Pressing the button again reactivates the automatic system (white button text).

Info icons

Alongside position and status information, icons on the manual page show how automatic mode is currently working and whether there is a block, which inhibits manual operation for example.

Icon GREY: Function has been set up in the automatic menu but is not currently active.

Icon WHITE: Function is active.

Icon RED: Alarm active.

Block by the rain, wind or frost alarm



If a motor group is currently blocked for manual operation by a rain, wind or frost alarm, no Up/down arrow keys are displayed. The red icons show the alarm for the relevant motor groups.

If there is a **frost alarm**, the icon for the key is identified by a surrounding. Press the key for approx. 1 second in order to release manual mode again. The frost lock will then only be active for this drive again when it is reactivated manually or the next time the frost alarm is triggered.



ATTENTION

Damage to property if frozen shades move!

Motor and curtain can be damaged if a frozen outside shade is moved.

- Before switching off the frost alarm manually, ensure that the rails are not frozen.

Icons for various functions:



Smoke alarm!
Manual operation blocked.



Wind alarm!
Manual operation blocked.



Rain alarm!
Manual operation blocked.



Frost alarm!
Manual operation blocked.



Block active!
E.g. ventilation prevented because of active fire, block as a result of safety contact.



Motion detector alarm!



Automatic block.
E.g. after wind alarm



The indoor sensor selected for automatic mode is defective.



The drive performs a reference run.

Icons for shades:



Brightness to low.
No shading



Shading active, because the position of the sun is appropriate.



Indoor temperature too low.
No shading



Outside temperature too low.
No shading



Brightness requires shade.



Night closing active.



Time closing active



Time opening active



Retraction and extension delay has not yet expired.

Icons for windows/ventilation:

CO2/VOC value too high.
Ventilation active.



Humidity too high.
Ventilation active.



Outside temperature too high.
No ventilation



Outside temperature too low.
No ventilation



Night back cooling active



Indoor temperature too high.
Ventilation/air-conditioning active.



Night temperature for ventilation active.



Waiting time between steps at the step window.



Gap ventilation active.



Time ventilation active.



Time closing active.



Outside temperature too low.
Limited opening position for windows.



Air-conditioning unit in use.
Ventilation prevented.



Circulation air for heat gain



Circulation air for preventing condensation.

Icons for light:



Twilight/night.
Light on.



Time switching.

Icons for heating:



Indoor temperature too low.
Heating on.

Icons for roof heating:



Outside temperature in the heating range.

2.3.2. External keys

Apart from operations via the display, it is possible to connect external buttons (wall buttons) to the Control System. The individual buttons can be assigned in the system menu to any motors or devices.

- System > Installation > Ext. keys
- 5.1.2. Set multifunction outputs, Page 76

2.3.3. Internal keys (group keys)

It is possible to operate several motors or devices at the same time via a joint group key (internal software key). For example, all windows can be closed by pressing just one key. You can set up these group keys in the system menu.

- System > Installation > Int. keys
- 5.1.6. Allocate internal keys (group keys), Page 86

2.3.4. Remote control

Motors and devices can be controlled by using the remote controller Remo 8 and Remo pro, which can be ordered among the accessories. The manual transmitter has to be taught as a radio participant in the Control System, then the motors and devices are allocated to the eight remote control channels. Several Remo 8 (pro)s can be taught to the Control System.

- System > Installation > Radio connection
- 5.1.4. Wireless connections, Page 78

2.3.5. WS1000 Connect App

The **WS1000 Connect App** is available for Android and iOS free of charge in the respective APP store.

Install the App on the mobile device. As soon as the mobile device and WS1000 Connect are on the same network (WLAN), the **WS1000 Connect Control System** can be controlled via the App.

Up to nine mobile devices can be connected to the **WS1000 Connect Control System** at the same time.

Access via the App to the Control System can be password-protected or completely prevented.

□ System > Set up WS1000 > Access codes

📖 5.2.3. Access code

If you want to operate the Control System and your building technology on the go, then use the **WS1000 Connect App** and set up a secure VPN connection for your home network. App access via VPN only works after the app has already been used once in the internal WLAN. In the Internet router, DHCP IP address assignment should be set to always assign the same IP address.

If two **WS1000 Connect Control Systems** are installed in one building, so that the App control is possible they have to be connected to different WLAN networks.

2.3.6. Navigate in the system menu

All settings for motors and devices for automatic mode and the Control System are changed in the system menu, which you reach via the **system** key. The menu can be protected with a password, see 5.2.3. Access code, Page 96.

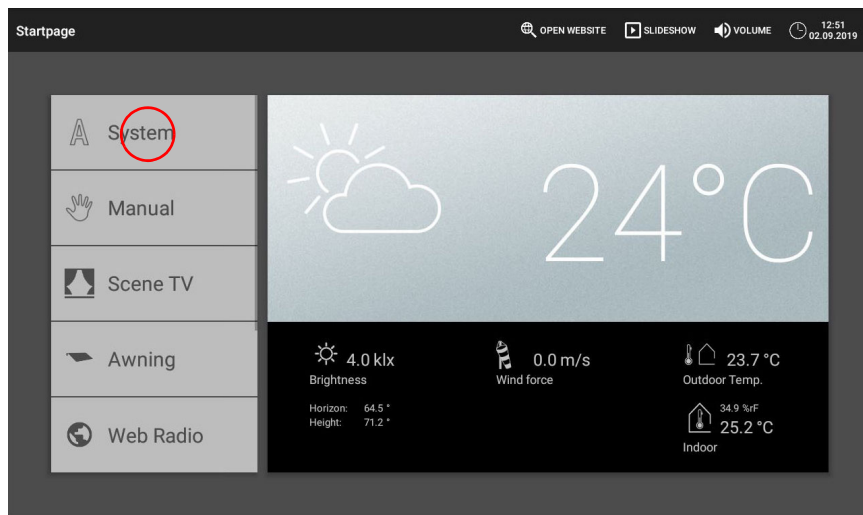

You can enter the following settings in three submenus.

Installation:

- Input basic properties of the motors and devices at the inputs/outputs
- Assign wall switches
- Set up group switches and scenes for the manual menu
- Teach radio connections to devices
- Weather data
- Set up the start page and the manual menu
- Configure presence simulation

Set-up automatic:

- Specify automatic functions of the individual motors and devices
- Adjust general automatic settings: Twilight value, travel delays, timer, ventilation block, night back cooling, frost alarm, movement limit, wind delay and automatic reset

Set up WS1000:

- Change individual data such as time/date and time and match the screen display to your personal desires (settings)
- Restart the Control System, reset to factory settings, change internal settings and start remote maintenance (service)

- Set an access code to protect the menus "Installation" and "Set-up automatic" against unauthorised change (access code)
- Save the setting details for the Control System on SD card or read from SD card (SD card)
- Set up the internet/network connection (internet)
- Load updates and check the software versions of the Control System (device information)

On the **bottom edge of the display** you will see a **Navigation menu** with "Back" arrow and a circle, which takes you back directly to the start page.

2.4. Internet (browser)

The **WS1000 Connect Control System** includes a browser for accessing internet pages on the WorldWideWeb. Note, however, that the control is not suitable for rendering resource-intensive web pages.

There must be an internet connection in order to use the browser (see chapter *Network connection (internet)*).

Start the browser via "Open website" in the top menu bar. Enter the web address (URL). Navigate by touching the screen (touch display).

Web sites can be displayed in the display area on the right or as a full screen. The switch field is located on the lower edge of the display. The "Create bookmark" button is also located here. This creates a link (bookmark button) in the start menu below system and manual functions, with which the website can be accessed quickly.

You can subsequently edit the name of the bookmark in the menu:

System > Installation > Homepage > Bookmarks

You can also delete the individual bookmarks here.

You cannot display or download PDF documents in the browser of the **WS1000 Connect Control System**.

2.5. Slide show

The **WS1000 Connect** can display digitally saved picture data as a slide show. The picture data for this must be saved on an SD card.

The card socket is located on the right-hand side of the device. The SD card is pushed into the slot, until it clicks into place.

To remove, briefly press the card into the socket so that it jumps out.



The picture files must meet the following requirements:

- The files must be saved in the highest directory level of the card (master directory)
- File format: Bitmap (BMP, without RLE compression), Jpeg (JPG), GIF or PNG (without transparency)
- For pictures with a page ratio other than 16:10, black bars are added at the top/bottom or right/left. The display has a resolution of 1280 × 800 pixels
- Colour intensity 24 bit or 16 bit

If picture data is saved on the card, the "Slide show" key is displayed on the right of the upper menu bar, with which you can directly start it. The image changes approx. every 45 seconds (for images with 24-bit colour intensity). To interrupt the screen saver, touch the screen or remove the SD card.

3. Automatic

3.1. Set-up automatic

☐ System > Set-up automatic

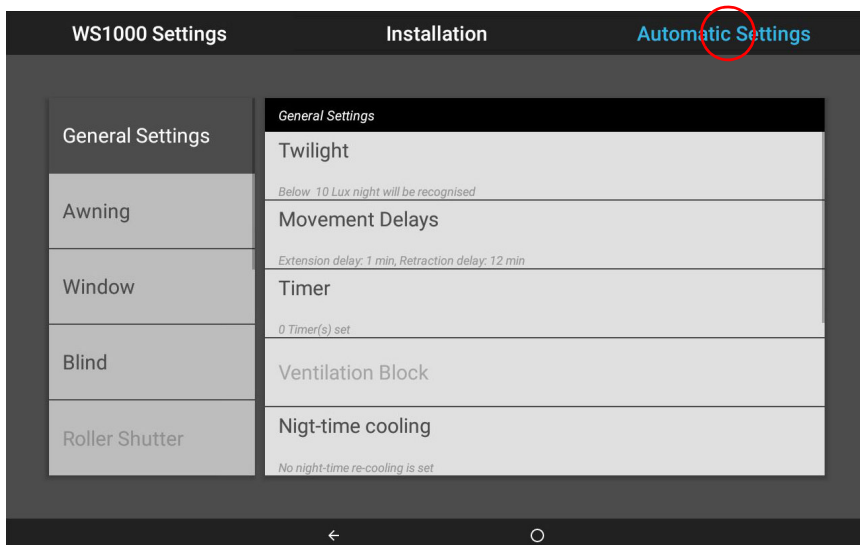
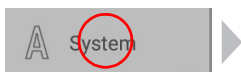

You can make the following settings in the menu **System > Set-up automatic**:

- Specify automatic functions of the individual motors and devices
- Adjust general automatic settings: Twilight value, travel delays, timer, ventilation block, night back cooling, frost alarm, movement limit, wind delay and automatic reset

In order to be able to set the automatic functions, the basic setting must already be complete.

📖 5. Grundeinstellung, Page 73

Adjust the settings for motors and devices to the individual situations. This is the only way alarm and block functions such as rain or wind warnings can help to protect external awnings, for example, or prevent rain entering the window.

3.1.1. Safety notice for automatic and alarm functions

**WARNING!****Risk of injury due to automatically moved components!**

The automatic control may cause parts of the system to travel and pose a danger to humans.

- No persons may remain in the travelling range of parts driven by an electric motor.
 - Adhere to the relevant building regulations (see guideline for power-operated windows, doors and gates BGR 232 et al).
 - Always disconnect the system from the mains power before maintenance or cleaning (e.g. switch off/remove fuse).
-

Precipitation warning for automatically controlled windows:

Some time can pass before falling rain is recognised by the sensors in the system, depending on the rain amount and outdoor temperature. Furthermore, a closure time must be calculated for electrically-actuated windows or sliding roofs. Humidity-sensitive items should therefore not be placed in an area where they might be damaged by incoming precipitation. Please also bear in mind that in the event of a power failure and rainfall, a window will not be automatically closed if no emergency generator is installed.

Running rails of shades icing up:

Note that the rails of shutters, awnings and blind which are externally mounted can ice up. Operating the drive under such conditions can damage the shades and drives.

Power failure, maintenance works, etc. (restart of control)

If a power outage occurs, the control unit can no longer control the connected drives! If the functional scope must be guaranteed even during a power cut, an emergency power unit with a corresponding switch from network power to emergency operation should be installed by the customer.

Settings saved in the control unit programme will be maintained even during a power outage.

Note: After every re-start (e. g. return of voltage after mains failure or manual reset) all drives and devices with active automatic reset are in automatic mode.

If cleaning or maintenance work is to be carried out in the conservatory/building, the control system must be de-energised and secure against restart by disconnection of the customer-installed fuse. This ensures that the connected drives cannot start.

3.2. Adjust general automatic settings

System > Set-up automatic > General settings

The settings made here are used for all motors and devices or they apply to specific motor types named in the corresponding chapter (e.g. to all shades).

3.2.1. Change twilight

System > Set-up automatic > General settings > Twilight

The twilight value is the brightness limit, below which twilight/night is detected. Note that brightness values of just below 10 Lux can be achieved with a full moon. If the twilight value is set below 10 Lux, shades set for "Night closing" can remain open or extend during the night because of the moonlight.

Twilight:

Displays the twilight limit. Touch the field to adjust the value using a slider.
Default: 10 lx.

3.2.2. Change travel delay (shades)

System > Set-up automatic > General settings > Travel delays

The travel delay prevents the sun protection system from continuously extending and retracting in the event of rapid changes in lighting conditions.

The brightness must remain uninterrupted above the extension delay time set for sun protection for a set delay time (e.g. 1 minute) before the blind will extend. The light intensity for the set retraction delay time (e.g. 12 minutes) must be below this value uninterrupted before the blind retracts again. Through a clever selection of the delay, passing clouds are "disregarded" and the shading still reacts quickly to the sun.

Travel delays:

Shows the extension and retract delay in minutes. Touch the field to use the slider to adjust the delay for extending when the sun is out and retracting.
Default: Extension 1 minute, retraction 12 minutes.

3.2.3. Set timer

System > Set-up automatic > General settings > Timer

16 periods can be set in the weekly clock, which can be used for different automatic functions. A start and end point, as well as a week of the day must be set for each time period.

Timer:

Shows how many timers are set. Touch the field to set up timers.

Select a timer from the list on the right and set it. The fields show **Timer 1...16** until settings have been entered. The entered name is displayed later.

Enter a **name** to help you assign the motor or device later.

Select **Begin** and **End**.

Select the **week days**, for which the time is to apply.

3.2.4. Adjust ventilation lock (air-conditioning unit)

System > Set-up automatic > General settings > Ventilation block

Windows are closed and fans switched off as soon as a cooling unit / air-conditioner is activated. When the cooling is switched off again, the ventilation remains inactive for some time to ensure that cooled air is not immediately passed out through windows or fans. You can adjust the delay time for this.

The ventilation block is also triggered by devices that are connected to a multifunction input as air-conditioning alarm.

Ventilation block:

Shows how long the ventilation remains blocked after a air-conditioning unit has switched off. Touch the field to adjust period value using a slider.

Default: 120 minutes.

3.2.5. Set night back cooling (ventilation)

System > Set-up automatic > General settings > Night back cooling

The night back cooling by window and ventilation device is activated if a set outside temperature is exceeded for a longer period.

"Night back cooling" is then displayed on the start page.

 6.4. Alarm and error messages > Night back cooling, Page 106

The window(s) and ventilator(s) which are used for the night-time re-cooling, as well as the time period over which these are activated, can be set in the automatic operation functions for the individual windows and ventilators.

Night back cooling:

Shows the settings for the night back cooling as soon as the back cooling has been set up. Touch the field to perform the configuration.

Switch the night back cooling **On** in order to set up and use for windows / fans.

Use the slider to set how high the **outside temperature** must have been in the last few hours in order to start the cooling.

Default: 16°C.

Set the **duration**, for which the outdoor temperature must have been above the minimum temperature (trigger period).

Default: 48 hours.

The night back cooling is ended when the set outside temperature is undercut by 2°C for a set period. This period depends on the trigger period set and the duration of the temperature exceedance. It is a maximum of one third of the set trigger period (e.g. max. 12 hours for a 48-hour trigger period).

3.2.6. Adjust frost alarm

☐ System > Set-up automatic > General settings > Frost alarm

The frost alarm for blinds and windows will be active when during or after precipitation the outdoor temperature falls below a defined level.

"Frost alarm" is then displayed on the start page.

📖 6.4. Alarm and error messages > Frost alarm, Page 106

You can set which shades are retracted and which windows are closed if there is a frost alarm in the automatic functions of the individual shades and windows. The frost alarm blocks all automatic functions and manual operation for these motors.

The frost alarm is triggered by the following situations:

- The outdoor temperature is below the set frost alarm temperature and it is beginning to rain/snow.
- The outdoor temperature drops below the set frost alarm temperature while it is raining/snowing.
- It has rained/snowed. During the set readiness period after the end of rainfall period, the outside temperature falls below the frost temperature set.

The frost alarm ends in the following situation:

- The outdoor temperature remains above the set dew point temperature for the period of time.

Frost alarm:

Shows the settings for the frost alarm as soon as it has been set up. Touch the field to perform the configuration.

Switch the frost alarm **On** in order to set it up and use it for motors.

First determine when the frost alarm is to be triggered.

Use the slider to set the **outside temperature** which must be **undercut** in order to trigger the frost alarm.

Default: 2.0°C.

Then set how many **hours** after precipitation the frost alarm standby mode should be active. Select the standby period in a way ensuring that the humidity left from the previous precipitation has all dried up.

Default: 5 h.

Now select the conditions for stopping the frost alarm.

Set which **external temperature** must be **exceeded**.

Default: 5.0°C.

And for how many **hours** this temperature has to be exceeded. Select the period such that ice is then fully thawed.

Default: 5 h.

3.2.7. Set movement limit (windows)

□ System > Set-up automatic > General settings > Movement limit

The movement limit determines that a window only opens partly when the outdoor temperature is low. This prevents excessive cooling of the room.

"Travel delay" is then displayed on the start page.

📖 6.4. Alarm and error messages > Window movement limit, Page 106

The degree to which the opening should be limited is set within the automation functions for the different windows.

Movement limit:

Shows the settings for the movement limit as soon as it has been set up. Touch the field to perform the configuration.

Switch the movement limit **On** in order to set up and use for windows.

First set the **outside temperature** beneath which the movement range of the windows should be limited.

Default: 2.0°C.

Then set how many **hours** the outside temperature must be above the set outside temperature so that the movement limit is lifted again.

Default: 8 hours.

3.2.8. Set wind delay (shades)

□ System > Set-up automatic > General settings > Wind delay

If the wind limit for a motor is exceeded, the wind alarm is triggered for 5 minutes. If the wind value is exceeded again during this period, the waiting time of 5 minutes starts again.

For shades, a delay time after the wind alarm can also be set, during which the shade controls is blocked. This means the controls initially remain switched off after the wind

alarm if the shade was in automatic mode before the wind alarm. Manual operation is possible again, however.

Wind delay:

Shows the duration of the wind delay. Touch the field to adjust the duration using a slider.

Default: 0 minutes.

3.2.9. Specify automatic reset

System > Set-up automatic > General settings > Automatic reset

After a manual operation, the relevant motor or device always remains in manual mode, automatic mode is switched off. However, you can set automatic mode to switch on again after a certain period. Motors and devices are also reset to automatic with the general automatic reset.

The automatic reset prevents motors being operated manually and then remaining in an unfavourable position (window inadvertently remains open, blind remains retracted despite the sun).

The general automatic reset and reset after a manual operation can be activated and deactivated in the automatic menu for each working group and each device separately.

Automatic reset:

Shows the time of the automatic reset and the period to reset after manual operation. Touch the field to change the two settings.

Set the **time for the daily automatic reset**.

Default: 3:00 a.m.

Set the **period after a manual operation**, after which automatic mode is to be activated again.

Default: 60 minutes.

3.3. Set automatic for motors and devices

3.3.1. Motors and devices without automatic functions

Devices (e.g. lights) connected via the "**Dimming**" output do not have automatic functions. However, they can be operated manually via the display.

3.3.2. Set automatic sun protection

System > Set-up automatic > Awning | Blind | Shutters

You can change the following Set-up automatic for connected awnings, blinds and shutters:

- Light intensity
- Direction of sun
- Height of sun
- Actuation position
- Slat position (for blinds)
- Indoor sensor which is evaluated
- Indoor temperature block
- Night closing
- Rain automation
- Time closing
- Actuation position for time closing
- Outside temperature block
- Behaviour during outside temperature block
- Time opening
- Frost alarm
- Wind sensor which is evaluated and delay
- Wind alarm
- Rain alarm
- Automatic reset

Alarm functions

The alarm functions are applied to shades in manual mode and automatic mode.

Fire alarm from a smoke detector has the highest priority. All shades are retracted and cannot be affected by automatically or manually.

If there is a **frost, wind or rain alarm**, shades are retracted and cannot be extended manually.

Shade settings

The settings are only executed if a blind is in automatic mode and none of the alarm functions named above is active.

The **outside temperature block** has the highest priority, followed by **time closing** (extend), **night closing** (extend) and **temperature block** (keep retracted).

The **automatic shading according to light intensity** is performed only when the direction and height of the sun are correct.

Set-up automatic

Light intensity:

Shows the brightness from which shades are deployed. Touch the field to set the shading.

Set whether the sun protection is extended **never, always or depending on brightness**. In the setting "Never", the sun protection does not react to the brightness and remains retracted. In the setting "Always", it remains extended. The controls are time and twilight-dependent, if applicable, and it is also controlled through manual movement.

Default: Brightness-dependent.

You set the **light intensity** limit value for the "Brightness-dependent" setting.

Default: 40 klx.

So that the automatic controls react, the light intensity value must be exceeded or undercut for the duration of the delay times. This prevents constant extension and retraction of the shades if the light conditions are rapidly alternating. The travel delays can be adjusted.

System > Set-up automatic > General settings > Travel delays

 3.2.2. Change travel delay (shades), Page 34

Direction of sun:

Shows the area (direction of the sky) where the sun must be so that the shade is opened. Touch the field to set the direction of the sun. The setting is only active if shading is deployed depending on the brightness.

Use the keys to select: from **All sides, West, South-West, South, South-East or East**. Or enter the angle range numerically in °.

Default: All sides.

If no time signal has been received and the time has not been set manually ("Please set the time!" is displayed on the start screen, shades are only controlled according to light intensity, temperature and alarm messages; the position of the sun is disregarded.

Height of sun:

Shows the area (height above the horizon) where the sun must be so that the shade is opened. Touch the field to set the angle using a slider. The setting is only active if shading is deployed depending on the brightness.

Default: 0-90°.

If no time signal has been received and the time has not been set manually ("Please set the time!" is displayed on the start screen, shades are only controlled according to light intensity, temperature and alarm messages; the position of the sun is disregarded.

Actuation position:

Shows the actuation position in percent for automatic mode. Touch the field to set the position using a slider. 0% = fully retracted, 100% = fully extended.

Default: 75%.

Select whether a reference run is to be carried out before the shading position.

If **No** is selected, the shade moves directly to the set position.

If **Yes** is selected, the shade first retracts completely and then moves to the set position.

Slat position (only blinds)

Shows the behaviour of the slats in automatic mode. Touch the field to adjust the setting.

Select whether the slats should follow the sun.

If **No** is selected, set the position using the slider. 0% = horizontal, 100% = closed. Default: 75%.

If **Yes** is selected, sun position tracking is active. Set the slat position for the four predefined sun angles.

Default: 0° to 15°: 100% (closed), 15° to 30°: 75%, 30° to 45°: 50%, 45° to 90°: 0% (horizontal).

Sensor selection:

Shows the indoor sensor, which is evaluated for controlling the shades. Touch the field and select a sensor.

Default: No sensor.

If no sensor is selected, the indoor temperature is not taken into account for the controls of the shading.

Indoor temperature:

Shows the setting for the indoor temperature block. The setting is only active if an indoor sensor is selected. Touch the field to adjust the indoor temperature block.

Select **OFF** if the shading should be independent of the indoor temperature (default).

Change to **ON** to set the desired temperature.

Default: 25.0 °C.

By using the indoor temperature block, the sun's energy is used to heat the room. If the indoor temperature is below the set value, e.g. in the morning, then the shades remain retracted despite the sun.

As soon as the set indoor temperature is exceeded, the block is lifted and the shades released.

If the indoor temperature decreases, the block is activated as soon as the temperature is more than 3.0°C below the set value (hysteresis). Note that the shades are only retracted when the travel delay time has passed.

System > Set-up automatic > General settings > Travel delays

 3.2.2. Change travel delay (shades), Page 34

Night closing:

Shows whether the shades are extended or not at night. Touch the field and switch the night closing on or off.

The limit value, from which twilight/night is detected, can be adjusted.

- System > Set-up automatic > General settings > Twilight
-  3.2.1. Change twilight, Page 34

Rain automation:

Shows whether the rain automatic is switched on. Touch the field and turn the rain automatic on or off for this shade and adjust the driving position and slat position if necessary.

Default: No.

The rain automatic is used to clean the curtains by rain and/or to protect the window panes from wetness by moving the shade to a selectable position.

The rain automatic can only be activated when the rain alarm is deactivated.

Time closing:

Touch the field to select periods when the shade should be extended. Activate one or more periods in the list.

If you want to change the periods, touch the tool icon.

-  3.2.3. Set timer, Page 34

Actuation position timer:

Shows the actuation position in percent for the time closing, also the slat position for blinds. Touch the field to set the position using a slider. Actuation position: 0% = fully retracted, 100% = fully extended.

Default: 100%.

Slat position: 0% = horizontal, 100% = closed.

Default: 100%

Outside temperature:

Shows the setting for the outside temperature block. Touch the field to adjust the block.

Select **OFF** if the shading should be independent of the outside temperature (default).

Change to **ON** to set the desired temperature. Default: 5.0 °C. The block is lifted again when the temperature rises more than 2.0 °C over the pre-set value (hysteresis).

The block only applies to automatic operation; no shading based on light intensity or the position of the sun takes place. The output still reacts to wind, rain and frost alarm even when the outdoor temperature block is active, as well as to night and timed travel commands and manual travel commands.

This is different to the frost alarm which retracts the shading and locks it against manual operation. When using the outdoor temperature block, please note that the shade rails or other mechanical components can remain iced even when the outdoor temperature has already risen to a relatively high value.



ATTENTION

Damage to property if frozen shades move!

Motor and curtain can be damaged if a frozen outside shade is moved.

- Use the frost alarm function to achieve reliable protection against damage due to freezing.

Behaviour:

Shows the behaviour of the shade if the outside temperature block is triggered. The setting is only active if an outside temperature has been specified.

Select whether the shade should retract if the blocked outside temperature is undercut. If **Yes** (retract), the shade is retracted after the end of the travel delay time (default) If **Non** (do not move), the shade remains in the current position. When the rain or wind alarm is triggered, the shade will still be retracted (the alarm has priority over temperature block).

Time opening:

Touch the field to select periods when the shade should be retracted. Activate one or more periods in the list.

If you want to change the periods, touch the tool icon.

 3.3. Set timer

The shade is raised at the time start of the open time but can still be lowered again manually. After the opening time, the normal automatic shade controls are executed.

Frost alarm:

Shows whether the shade is retracted if there is a frost alarm. Touch the field in order to switch the frost alarm on or off for this shade.

The frost alarm retracts the sun shade if the outdoor temperature is low and it is raining/snowing at the same time. This protects external shades from damage due to freezing and movement if the rails are frozen.

The conditions for triggering the frost alarm (outside temperature, period) are specified in the menu "General settings".

 System > Set-up automatic > General settings > Frost alarm

 3.2.6. Adjust frost alarm, Page 36

If there is a frost alarm, manual operation of the shade is initially blocked. You can remove the manual block by hand however. To do this, select the corresponding shade

in the Manual menu and hold down the key with the frost alarm icon for approx. 1 second. Manual operation is released again. The block will then be first active for this drive again when it is reactivated manually or the next time the frost alarm is triggered.

Note that the running rails of the shade or other mechanical parts may still be frozen even if the outside temperature has already risen to quite high values.



ATTENTION

Damage to property if frozen shades move!

Motor and curtain can be damaged if a frozen outside shade is moved.

- For sensitive curtains, set frost alarm range generously.
- Before switching off the frost alarm manually, ensure that the rails are not frozen.

Wind sensor:

Shows the delay for the wind sensor. Touch the field to select the sensor (if there are several wind sensors), and to set how long the wind limit value must be exceeded before the wind alarm is triggered.

Default: 5 seconds

Wind alarm:

Shows the value, from which the wind alarm is triggered. Touch the field and set the wind speed. Default: 6.0 m/s. If the shade should not react to the wind (e.g. for indoor awnings, shutters), switch the wind alarm **OFF**.

The wind alarm protects sensitive curtains from wind damage by retracting the shades.

A wind alarm actuated for the drive will remain active for 5 minutes. In addition, a wind delay can be set for the shades. After the end of the wind alarm, the automatic controls are switched off for the specified period. Manual operation is possible again, however.

System > Set-up automatic > General settings > Wind delay

3.2.8. Set wind delay (shades), Page 37

Rain alarm:

Shows whether the rain alarm is switched on. Touch the field and switch the rain alarm on or off for this shade.

Default: No.

The rain alarm protects sensitive curtains from rain by retracting the shades.

The rain alarm can only be activated if the rain automatic is deactivated.

Automatic reset:

Shows which automatic resets apply to this shade. Touch the field in order to activate the daily automatic reset and/or reset after a manual operation.

The general Automatic Reset occurs daily at the same time. Additionally, the automatic controls can be reactivated a certain period after a manual operation. You can set the time or period for automatic resets.

System > Set-up automatic > General settings > Automatic reset

 3.2.9. Specify automatic reset, Page 38

3.3.3. Set automatic window controls

System > Set-up automatic > Windows

For connected windows, you can change the following automatic settings.

- Indoor sensor which is evaluated
- Indoor temperature
- Humidity
- CO₂ (only if a CO₂ sensor is installed)
- Incoming air temperature
- Number of steps
- Actuation position
- Night back cooling
- Indoor temperature for actuation position for night back cooling
- Time ventilation
- Movement limit and position for time ventilation
- Outside temperature
- Time closing
- Wind sensor which is evaluated and delay
- Wind alarm
- Rain alarm
- Gap ventilation
- Position during gap ventilation
- Frost alarm
- Automatic reset

Alarm functions

The alarm functions are applied to windows in manual mode and automatic mode.

Fire alarm from a smoke detector has the highest priority. All windows are opened and cannot be affected by automatically or manually.

If there is a **burglary alarm** from a motion detector, all windows are closed. The windows can immediately be operated again after the burglary alarm.

If there is a **frost, wind or rain alarm**, all windows are closed and cannot be opened manually. Gap ventilation during a rain alarm is an exception; in automatic mode it only restricts the window's range of motion.

As soon as a connected **air-conditioning unit** is **activated**, all windows are closed. They are then in automatic mode but can immediately be operated again. The delay time for the ventilation block can be set via the air-conditioning unit.

System > Set-up automatic > General settings > Ventilation block

 3.2.4. Adjust ventilation lock (air-conditioning unit), Page 35

Ventilation settings

The settings are only executed if a window is in automatic mode and none of the alarm functions named above is active.

Time closing, has the highest priority, followed by the **outside temperature block** (keep closed), **time ventilation** (open), **incoming air temperature block** (keep closed) and **night back cooling** (open).

This means that e.g. timed ventilation or night-time re-cooling will only occur, when the exterior temperature lies over the pre-set value for the outdoor temperature block.

Automatic ventilation according to temperature or humidity is only performed if no block is active.

Set-up automatic

Sensor selection:

Shows the indoor sensor, which is evaluated for controlling the windows. Touch the field and select a sensor.

Default: No sensor.

If no sensor is selected, the indoor temperature and humidity are not taken into account for the controls of the window.

Indoor temperature:

Shows the indoor temperature from which ventilation is active. The setting is only active if an indoor sensor is selected. Touch the field to adjust the indoor temperature.

Select **OFF** if the window should not react to the indoor temperature (default).

Change to **ON** to set the desired temperature. Default: 21.0 °C. The window is opened as soon as the temperature lies above the pre-set value. However, it is only closed again when the temperature sinks by more than 2.0 °C under the pre-set value (hysteresis).

Humidity:

Shows the humidity from which ventilation is active. The setting is only active if an indoor sensor is selected. Touch the field to adjust the humidity.

Select **OFF** if the window should not react to the humidity (default).

Change to **ON** to set the desired humidity. Default: 80%. The window is opened as soon as the air humidity lies above the pre-set value. However, it is only closed again when the humidity sinks by more than 3.0% under the pre-set value (hysteresis).

CO₂:

Shows the CO₂ concentration from which ventilation is active. The setting is only active if an indoor sensor with CO₂ sensor is selected. Touch the field to adjust the CO₂ value.

Select **OFF** if the window should not react to CO₂ (default).

Switch to **ON** in order to set the CO₂ concentration range. Default: Open above 1000 ppm, close below 700 ppm.

Incoming air temperature:

Shows whether the window is closed if the incoming air temperature is greater than the room temperature (heat protection). Touch the field and switch the incoming air temperature sensor on or off. Default: No (off).

The supply air temperature-block becomes active as soon as the supply air temperature lies above the room temperature. The block is however only deactivated again when the supply air temperature sinks more than 3.0 °C below the room temperature (hysteresis).

Number of steps:

Shows the number of opening steps for the window. Touch the field in order to activate the **step windows** and set the number of steps.

Default: No step mode.

With step windows, in automatic mode the window first opens one step wide when the limit values are exceeded. Then every 3 minutes the Control System check whether a set room temperature or humidity is still exceeded and then, if applicable, move the window by another step.

Actuation position:

Shows the actuation position in percent for automatic mode. Touch the field to set the position using a slider. 0% = closed, 100% = fully open.

Default: 100%.

Night back cooling:

Touch the field to set the times for night back cooling. The setting is only active if the general settings for the night back cooling have already been made.

System > Set-up automatic > General settings > Night back cooling

 3.2.5. Set night back cooling (ventilation), Page 35

Activate one or more periods in the list. If you want to change the periods, touch the tool icon.

 3.2.3. Set timer, Page 34

Be careful that your timer settings do not prevent night-time re-cooling operations!

NBC indoor temperature (night back cooling):

Shows the indoor temperature, to which room is cooled. Touch the field to set the indoor temperature, until which the window remains open during the night back cooling. The setting will only be activated once a night-time re-cooling temperature has been set.

Default: 20.0°C.

NBC actuation position (night back cooling):

Shows the actuation position in percent during night back cooling. Touch the field to set the position using a slider (0% = closed, 100% = fully open). The setting will only be activated once a night-time re-cooling temperature has been set.

Default: 30%.

Time ventilation:

Touch the field to set the ventilation period. Activate one or more periods in the list. If you want to change the periods, touch the tool icon.

 3.2.3. Set timer, Page 34

The window is only opened if the specified outside temperature is reached. At the end of the ventilation time, normal automatic ventilation takes place according to temperature and humidity.

Movement limit:

Shows whether the movement limit is switched on for lower outside temperatures for this window. Touch the field to change the setting.

The conditions for triggering the movement limit (outside temperature, period) are specified in the menu "General settings".

System > Set-up automatic > General settings > Movement limit

 3.2.7. Set movement limit (windows), Page 37

To position (movement limit):

Shows the position to which the window opens if the movement limit is on. The setting is only active if the movement limit has been switched on. Touch the field and set the maximum open position (0% = closed, 100% = fully open).

Default: 50%.

The window can still be fully opened manually.

Outside temperature:

Shows the setting for the outside temperature block. Touch the field to adjust the block.

Select **OFF** if the window should be independent of the outside temperature (default).

Change to **ON** to set the desired temperature. Default: 1.0 °C. The block is lifted again when the temperature rises more than 2.0 °C over the pre-set value (hysteresis).

The effect of the block is that the window remains in the current position. The outside temperature block can be used, for example, if the window should not be used for ventilation (cold protection for plants).

The outdoor temperature block only applies for automatic operation; no ventilation then takes place. When the rain or wind alarm is triggered, the window will be closed despite the outdoor temperature block (the alarm has priority over temperature block).

Manual operation remains possible, even if the window is clocked because of a low outside temperature.

Time closing:

Touch the field to select periods when the window should be closed. Activate one or more periods in the list.

If you want to change the periods, touch the tool icon.

 3.3. Set timer

Shut-off times prevent the windows, for example, from opening and closing at night, and thus causing noise. Note that night back cooling is not possible during the set period.

Wind sensor:

Shows the delay for the wind sensor. Touch the field to select the sensor (if there are several wind sensors), and to set how long the wind limit value must be exceeded before the wind alarm is triggered.

Default: 5 seconds

Wind alarm:

Shows the value, from which the wind alarm is triggered. Touch the field and set the wind speed. Default: 8.0 m/s. If the window should not react to wind, switch the wind alarm **OFF**.

The wind alarm protects the system and equipment from damage by closing the window. Manually opened windows are also closed if there is a wind alarm.

A wind alarm actuated for the drive will remain active for 5 minutes. If the saved value is exceeded in these 5 minutes, the stoppage time will be restarted.

Rain alarm:

Shows whether the rain alarm is switched on. Touch the field and switch the rain alarm on or off for this window.

Default: No.

The rain alarm provides protection from humidity damage by closing the window. Manually opened windows are also closed if there is a rain alarm.



ATTENTION

Damage from entering rain!

Depending on the amount of rain and the temperature, some time may pass until the Weather station rainfall is detected.

- Do not place items that are sensitive to humidity near automatic windows.
- Calculate movement time for closing the window.

Gap ventilation:

Shows whether the window remains ajar when it is raining. This setting is only active when the rain alarm has been switched on. Touch the field in order to switch off gap opening if there is a rain alarm.

When gap opening, the window can still be opened slightly despite a rain alarm.

Gap ventilation is not possible if MSG control (continuous signal) has been activated in the window's basic settings in the installation menu.

5.1.1. Set motors and motor groups, Page 73

Gap position:

Shows the position to which the window opens for gap ventilation. The setting is only active if gap ventilation has been switched on. Touch the field and set the open position (0% = closed, 100% = fully open).

Default: 5%.

Frost alarm:

Shows whether the window is closed if there is a frost alarm. Touch the field in order to switch the frost alarm on or off for this window.

The frost alarm closes the window if the outdoor temperature is low and it is raining/snowing at the same time. This prevents damage from ice (e.g. at the seal).

The conditions for triggering the frost alarm (outside temperature, period) are specified in the menu "General settings".

System > Set-up automatic > General settings > Frost alarm

3.2.6. Adjust frost alarm, Page 36

If there is a frost alarm, there is no timed ventilation or night back cooling.

If there is a frost alarm, manual operation of the window is initially blocked. You can remove the manual block by hand however. To do this, select the corresponding window in the Manual menu and hold down the key with the frost alarm icon for approx. 1 second. Manual operation is released again. The block will then be first active for this drive again when it is reactivated manually or the next time the frost alarm is triggered.

Automatic reset:

Shows which automatic resets apply to this window. Touch the field in order to activate the daily automatic reset and/or reset after a manual operation.

The general Automatic Reset occurs daily at the same time. Additionally, the automatic controls can be reactivated a certain period after a manual operation. You can set the time or period for automatic resets.

System > Set-up automatic > General settings > Automatic reset

 3.2.9. Specify automatic reset, Page 38

3.3.4. Set automatic ventilation

System > Set-up automatic > Ventilation

For connected roof ventilation units, supply air units and fresh air/heating combination units, you can change the following automatic settings:

- Indoor sensor evaluated for the fan
- Indoor temperature
- Humidity
- CO₂ (only if a CO₂ sensor is installed)
- Incoming air temperature (only for supply air units)
- Ventilation steps or exhaust air intensity (only for roof ventilators WL400/800 and fans on RF-VM)
- Circulation air for heat gain (only roof ventilator WL400/800)
- Circulation air for reducing condensation (only roof ventilator WL400/800)
- Night back cooling (and indoor temperature for night back cooling) or night mode
- Time ventilation (and intensity for time ventilation)
- Outside temperature (only for WL-Z and supply air units at multifunction outlets)
- Temperature for heating (only for fresh air/heating combination units on RF-VM)
- Automatic reset

Alarm functions

If there is a **fire alarm** from a smoke detector, ventilation is activated and cannot be influenced either by the automatic controls or manually.

As soon as a connected **air-conditioning unit** is activated, the ventilation is stopped, along with the manually started fans. The fans can immediately be operated manually again. The delay time for the ventilation block can be set.

System > Set-up automatic > General settings > Ventilation block

 3.2.4. Adjust ventilation lock (air-conditioning unit), Page 35

Ventilation settings

Ventilation according to **temperature, humidity and CO₂** is checked every second. For exhaust units (radio roof ventilators, fans on RF-VM) the power is increased as the values above the setpoint increase. The power is only reduced again, however, if the new required ventilation intensity is 20% lower than the current (delay/hysteresis). The set minimum and maximum ventilation intensity is maintained.

For supply air units (WL-Z fan at the MF output or radio relay), the ventilation flap is opened as soon as one of the values is above the specified setpoint. It is only closed again, however, if the new required ventilation intensity is 20% lower than the current (delay/hysteresis).

Set-up automatic

Sensor selection:

Shows the indoor sensor, which is evaluated for the Control System. Touch the field and select a sensor.

Default: No sensor.

If no sensor is selected, the indoor temperature and humidity are not taken into account for the Control System.

Indoor temperature (ventilation/heating):

Shows the indoor temperature, above which ventilation is active (and below which the fan heaters are active). The setting is only active if an indoor sensor is selected. Touch the field to adjust the indoor temperature.

Select **OFF** if the ventilation should be on irrespective of the indoor temperature.

Change to **ON** to set the desired temperature. The ventilation starts as soon as the temperature exceeds the set value. The ventilation is stopped if the temperature sinks by more than 2.0°C below the pre-set value (hysteresis).

For fan heaters, the heating is activated as soon as the temperature falls below the pre-set value. The heating stops when the temperature rises more than 0.5 °C over the pre-set value (hysteresis).

Night mode (fan heater):

Touch the field to adjust the times for night operation of the circulating air heating. Activate one or more periods in the list. If you want to change the periods, touch the tool icon.

 3.3. Set timer

Indoor temperature, night (fan heater):

Shows the indoor temperature below which the heating is engaged during the night. The setting will only be activated once a night operation time has been set. Touch the field to set the temperature.

Default: 20.0°C.

Humidity:

Shows the humidity from which ventilation is active. The setting is only active if an indoor sensor is selected. Touch the field to adjust the humidity.

Select **OFF** if the ventilation should be on irrespective of the humidity.

Change to **ON** to set the desired humidity. The ventilation starts as soon as the humidity exceeds the set value. The ventilation is stopped if the humidity sinks by more than 3.0% under the pre-set value (hysteresis).

CO₂:

Shows the CO₂ concentration from which ventilation is active. The setting is only active if an indoor sensor with CO₂ sensor is selected. Touch the field to adjust the CO₂ value.

Select **OFF** if the ventilation should be on irrespective of the CO₂ concentration.

Switch to **ON** in order to set the CO₂ concentration range. At the start value, ventilation begins at the smallest preset speed. The speed increases to the second value (maximum speed).

Default: Start above 1000 ppm, end below 700 ppm.

Exhaust air intensity (exhaust units):

For exhaust units, shows the speed range for automatic exhaust air. Touch the field and set the start and maximum values.

The higher the indoor temperature, humidity (and CO₂) above the set values, the faster the fan.

Ventilation intensity, heating (fan heater):

For fan heaters, shows the speed range for automatic heating. Touch the field and set the intensity.

Heat gain (circulation air units):

For ventilators WL400 and WL800, shows whether the circulation air function is used for heat gain. Touch the field to activate the function.

Select **Yes** in order to use the heat gain function. Set the indoor temperature, beneath which circulation should start, and the speed at which the fan should run.
Default: Indoor temperature below 9.0°C; with 3%.

With circulation, the heated air can be distributed from the first area in the entire room and thus used for heating if required. In principle, the circulation function only starts if the temperature at the fan is at least 3°C warmer than the indoor temperature.

Condensation (circulation air units):

For ventilators WL400 and WL800, shows whether the circulation air function is used to prevent condensation. Touch the field to activate the function.

Select **Yes** in order to use the condensation prevention function. Set the U value of the glass used (ask your window fitter or conservatory supplier for the value) and the speed at which the fan should run.
Default: U value 1.0; with 20%.

By circulating the air, the formation of condensation on the glass can be reduced.

Night back cooling:

Touch the field to set the times for night back cooling. The setting is only active if the general settings for the night back cooling have already been made.

System > Set-up automatic > General settings > Night back cooling

 3.2.5. Set night back cooling (ventilation), Page 35

Activate one or more periods in the list. If you want to change the periods, touch the tool icon.

 3.2.3. Set timer, Page 34

Be careful that your timer settings do not prevent night-time re-cooling operations! The set incoming air temperature block can also prevent night back cooling.

NBC indoor temperature (night back cooling):

Shows the indoor temperature, to which room is cooled. Touch the field to set the indoor temperature, until which the ventilation is active during the night back cooling. The setting will only be activated once a night-time re-cooling temperature has been set.

Default: 20.0°C.

NBC strength (night back cooling):

For exhaust air units, shows the speed during night back cooling. Touch the field to adjust the strength using a slider. The setting will only be activated once a night-time re-

cooling temperature has been set.
Default: 30%.

Incoming air temperature (supply air units):

Shows whether a supply air unit is closed if the incoming air temperature is greater than the room temperature (heat protection). Touch the field and switch the incoming air temperature sensor on or off. Default: No (off).

The supply air temperature-block becomes active as soon as the supply air temperature lies above the room temperature. The block is however only deactivated again when the supply air temperature sinks more than 3.0 °C below the room temperature (hysteresis).

For supply air units WL-Z, the incoming air temperature is recorded by a thermometer integrated in the WL-Z. For devices from other manufacturers, the outside temperature at the weather station is used as the value for the incoming air temperature.

Time ventilation:

Touch the field to set the ventilation period. Activate one or more periods in the list. If you want to change the periods, touch the tool icon.

 3.2.3. Set timer, Page 34

The ventilation flaps are only opened if the specified outside temperature is reached. At the end of the ventilation time, normal automatic ventilation takes place according to temperature and humidity.

Time ventilation intensity (exhaust units):

For exhaust units, shows the speed at which the time-controlled ventilation is performed. The setting will only be activated once a ventilation time has been set. Touch the field and adjust the intensity.

Default: 30%.

Outside temperature (supply air units):

For exhaust units, shows whether the winter switching is active. Touch the field to set the outside temperature, above which the ventilation unit should remain closed (winter switching).

Default: OFF or 1.0°C.

Automatic switch-off (fan heater):

Shows the behaviour of a fan heater after a manual operation. Touch the field and specify whether the heating remains on permanently after the manual switch-on of switches off again after how many minutes.

Automatic reset:

Shows which automatic resets apply to this ventilation. Touch the field in order to activate the daily automatic reset and/or reset after a manual operation.

The general Automatic Reset occurs daily at the same time. Additionally, the automatic controls can be reactivated a certain period after a manual operation. You can set the time or period for automatic resets.

- System > Set-up automatic > General settings > Automatic reset
-  3.2.9. Specify automatic reset, Page 38

Ventilation modes, radio roof fan

Ventilation modes with WL400 and WL800:

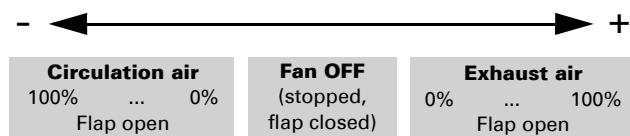

Each time the **OFF** state is reached, the speed change stops automatically, so that a direct change between exhaust and circulation modes is impossible.

3.3.5. Set automatic heating

- System > Set-up automatic > Heating

For connected heating, you can change the following automatic settings.

- Indoor sensor evaluated for the heating
- Indoor temperature, day
- Night mode (period) and indoor temperature, night
- Automatic switching-off
- Automatic reset

Sensor selection:

Shows the indoor sensor, which is evaluated for the Control System. Touch the field and select a sensor.

Default: No sensor.

If no sensor is selected, the indoor temperature is not taken into account for the Control System.

Indoor temperature, day:

Shows the indoor temperature below which the heating is engaged during the day. The setting is only active if an indoor sensor is selected. Touch the field and adjust the indoor temperature.

Default: 20.0°C.

The heating will engage as soon as the temperature drops below the set value and is shut down again when the temperature is more than 0.5°C above the set value (hysteresis).

Night mode:

Touch the field to adjust the periods for night operation using a slider. Activate one or more periods in the list. If you want to change the periods, touch the tool icon.

 3.2.3. Set timer, Page 34

Indoor temperature, night:

Shows the indoor temperature for night mode as soon as a period for night mode has been activated. Touch the field and adjust the indoor temperature.

Default: 20.0°C.

The heating will engage as soon as the temperature drops below the set value and is shut down again when the temperature is more than 0.5°C above the set value (hysteresis).

Automatic switching-off:

Shows the behaviour of the heating after a manual operation. Touch the field and specify whether the heating remains on permanently after the manual switch-on or switches off again after how many minutes.

Automatic reset:

Shows which automatic resets apply to this heating. Touch the field in order to activate the daily automatic reset and/or reset after a manual operation.

The general Automatic Reset occurs daily at the same time. Additionally, the automatic controls can be reactivated a certain period after a manual operation. You can set the time or period for automatic resets.

System > Set-up automatic > General settings > Automatic reset

 3.2.9. Specify automatic reset, Page 38

3.3.6. Set automatic air-conditioning

System > Set-up automatic > Air-conditioning unit

For connected cooling/air-conditioning units, you can change the following automatic settings.

- Indoor sensor evaluated for the cooling
- Indoor temperature, day
- Night mode (period) and indoor temperature, night
- Switch automatic reset on/off

Windows are closed automatically and fans switched off as soon as the cooling/air-conditioning is activated. The delay time can be set for this.

- System > Set-up automatic > General settings > Ventilation block
-  33.2.4. Adjust ventilation lock (air-conditioning unit), Page 35

Sensor selection:

Shows the indoor sensor, which is evaluated for the Control System. Touch the field and select a sensor.

Default: No sensor.

If no sensor is selected, the indoor temperature is not taken into account for the Control System.

Indoor temperature, day:

Shows the indoor temperature above which the cooling is engaged during the day. The setting is only active if an indoor sensor is selected. Touch the field and adjust the indoor temperature.

Default: 30.0°C.

The cooling will engage as soon as the temperature exceeds the set value and is shut down again when the temperature is more than 2°C below the set value (hysteresis).

Night mode:

Touch the field to adjust the periods for night operation using a slider. Activate one or more periods in the list. If you want to change the periods, touch the tool icon.

-  3.2.3. Set timer, Page 34

Indoor temperature, night:

Shows the indoor temperature for night mode as soon as a period for night mode has been activated. Touch the field and adjust the indoor temperature.

Default: 34.0°C.

The cooling will engage as soon as the temperature exceeds the set value and is shut down again when the temperature is more than 2°C below the set value (hysteresis).

Automatic reset:

Shows which automatic resets apply to this cooling. Touch the field in order to activate the daily automatic reset and/or reset after a manual operation.

The general Automatic Reset occurs daily at the same time. Additionally, the automatic controls can be reactivated a certain period after a manual operation. You can set the time or period for automatic resets.

- System > Set-up automatic > General settings > Automatic reset
-  3.2.9. Specify automatic reset, Page 38

3.3.7. Set automatic light controls

System > Set-up automatic > Light

For connected lights, you can change the following automatic settings.

- Timer
- Twilight switching
- Alarm reaction
- Automatic reset

If there is a smoke alarm, all lights are switched on.

Timer:

Touch the field to set the lighting periods. Activate one or more periods in the list. If you want to change the periods, touch the tool icon.

 3.2.3. Set timer, Page 34

As soon as you additionally activate the twilight setting, the light will only be turned on at twilight in the selected time periods.

Twilight:

Shows whether the light is switched on at twilight/night. Touch the field and switch the function on or off.

If the twilight setting is active, the light is only turned on at twilight in the time periods selected above.

The limit value, from which twilight/night is detected, can be adjusted.

System > Set-up automatic > General settings > Twilight

 3.2.1. Change twilight, Page 34

Alarm:

Shows whether the light is switched on if there is an alarm from a motion detector. Touch the field and select **Yes** or **No**.

Automatic reset:

Shows which automatic resets apply to these lights. Touch the field in order to activate the daily automatic reset and/or reset after a manual operation.

The general Automatic Reset occurs daily at the same time. Additionally, the automatic controls can be reactivated a certain period after a manual operation. You can set the time or period for automatic resets.

System > Set-up automatic > General settings > Automatic reset

 3.2.9. Specify automatic reset, Page 38

3.3.8. Set automatic gutter heating

System > Set-up automatic > Gutters

For connected gutter heating, you can change the following automatic settings.

- Temperature range in which the heating is switched on
- Automatic reset

Temperature range:

Shows the temperature range in which the gutter is heated. Touch the field and adjust the range.

Default: 5.0°C to -5.0°C.

If the temperatures are very low, no condensation occurs and the heating can be switched off.

Automatic reset:

Shows which automatic resets apply to this gutter heating. Touch the field in order to activate the daily automatic reset and/or reset after a manual operation.

The general Automatic Reset occurs daily at the same time. Additionally, the automatic controls can be reactivated a certain period after a manual operation. You can set the time or period for automatic resets.

System > Set-up automatic > General settings > Automatic reset

 3.2.9. Specify automatic reset, Page 38

3.3.9. Set alarm

Alarm output

System > Set-up automatic > Alarm

For multifunction outputs configured as alarms, you can set which alarms close the output.

- Motion detector (on a multifunction input)
- Rain alarm from the weather station
- Wind sensor. Select the wind sensor and set how long the wind limit value has to be exceeded before the wind alarm is triggered
- Wind alarm. Set the value for the wind speed. An actuated wind alarm will remain active for 5 minutes. If the saved value is exceeded in these 5 minutes, the stoppage time will be restarted.
- Smoke detector (on a multifunction input)
- Frost alarm from the Control System

Set motion detector

System > Set-up automatic > Alarm

If a motion detector is connected, periods can be set for when the Control System react to the motion alarms (alarm live). Activate one or more periods in the list. If you want to change the periods, touch the tool icon.

 3.2.3. Set timer, Page 34

If the alarm is triggered during this period, all windows close for approx. 5 minutes. "Motion alarm message" is displayed on the start page. Normal automatic mode is restored after 5 minutes if there is no new alarm signal.

Manually opened windows are also closed if there is a motion detector alarm.

If a multifunction output is configured as an alarm, it can forward the alarm message from the motion detector.

 3.3.9. Set alarm > Alarm output, Page 60

Light can also be switched on if there is an alarm from a motion detector.

 3.3.7. Set automatic light controls, Page 59

4. Installation and commissioning

4.1. Procedure



Installation, check, installation and troubleshooting of the Control System may only be performed by an expert electrician (according to VDE 0100).

1. The **installation** of the Control System and the sensors must be performed by a skilled electrician. Information in the installation instructions, for example also about the installation location, must be observed.
2. After completing the installation work, the Control System must be **thoroughly set up** in the menu *System > Installation*. Which connections are used for which functions, e.g. Motor 1 = Awning, is specified here.
See manual chapter *Basic setting*.
3. **More settings** for time reception, screen saver, network connection, access code, updates, etc. can be made at any time in the menu *System > WS1000 settings*.
See manual chapter *Basic setting*.
4. The **automatic functions** must be adjusted in the menu *System > Automatic settings* to the structural conditions and individual requirements of the users.
See manual chapter *Automatic*.

4.1.1. Operating system

The **WS1000 Connect** works with the Android operating system. However, the Control System work self-sufficiently and therefore no third-party Apps may be installed!

4.1.2. Protective film

Remove the protective film from the display. Otherwise, there is a risk that the touch operation will be deactivated. If this should happen, the control system must be restarted so that the touch display works again.

4.1.3. Installation notes



Installation, testing, operational start-up and troubleshooting should only be performed by an authorised electrician.



DANGER!

Risk to life from live voltage (mains voltage)!

There are unprotected live components inside the device.

- Inspect the device for damage before installation. Only put undamaged devices into operation.
 - Comply with the locally applicable directives, regulations and provisions for electrical installation.
 - Immediately take the device or system out of service and secure it against unintentional switch-on if risk-free operation is no longer guaranteed.
-

Use the device exclusively for building automation and observe the operating instructions. Improper use, modifications to the device or failure to observe the operating instructions will invalidate any warranty or guarantee claims.

Operate the device only as a fixed-site installation, i.e. only in assembled condition and after conclusion of all installation and operational start-up tasks, and only in the surroundings designated for it.

Elsner Elektronik is not liable for any changes in norms and standards which may occur after publication of these operating instructions.

4.1.4. Notes on wireless equipment

When planning facilities with devices that communicate via radio, adequate radio reception must be guaranteed. The range of wireless control will be limited by legal regulation and structural circumstances. Avoid sources of interference and obstacles between receiver and transmitter, that could disturb the wireless communication. Those would be for example:

- Walls and ceilings (especially concrete and solar protection glazing).
- Metal surfaces next to the wireless participants (e. g. aluminium construction of a conservatory).
- Other wireless devices and powerful local transmitters (e.g. wireless headphones), which transmit on the same frequency. Please maintain a minimum distance of 30 cm between wireless transmitters for that reason.

4.1.5. Safety notice for automatic and alarm functions



WARNING!

Risk of injury due to automatically moved components!

The automatic control may cause parts of the system to travel and pose a danger to humans.

- No persons may remain in the travelling range of parts driven by an electric motor.
- Adhere to the relevant building regulations (see guideline for power-operated windows, doors and gates BGR 232 et al).
- Always disconnect the system from the mains power before maintenance or cleaning (e.g. switch off/remove fuse).

Precipitation warning for automatically controlled windows:

Some time can pass before falling rain is recognised by the sensors in the system, depending on the rain amount and outdoor temperature. Furthermore, a closure time must be calculated for electrically-actuated windows or sliding roofs. Humidity-sensitive items should therefore not be placed in an area where they might be damaged by incoming precipitation. Please also bear in mind that in the event of a power failure and rainfall, a window will not be automatically closed if no emergency generator is installed.

Running rails of shades icing up:

Note that the rails of shutters, awnings and blind which are externally mounted can ice up. Operating the drive under such conditions can damage the shades and drives.

Power failure, maintenance works, etc. (restart of control)

If a power outage occurs, the control unit can no longer control the connected drives! If the functional scope must be guaranteed even during a power cut, an emergency power unit with a corresponding switch from network power to emergency operation should be installed by the customer.

Settings saved in the control unit programme will be maintained even during a power outage.

Note: After every re-start (e. g. return of voltage after mains failure or manual reset) all drives and devices with active automatic reset are in automatic mode.

If cleaning or maintenance work is to be carried out in the conservatory/building, the control system must be de-energised and secure against restart by disconnection of the customer-installed fuse. This ensures that the connected drives cannot start.

4.1.6. Installation of the weather station: see leaflet

4.2. Installation of the indoor sensor: see leaflet

4.3. Installation of the Control System: see leaflet

4.3.1. Connect motors and devices

Connect motor groups

Each motor that has to be controlled individually needs its own group. Single controls for motors, which are switched in one group, is not possible. Only motors with the same function (only windows, only awnings, only blinds, only shutters) can be formed into groups.

Shades with different alignments (east, south, west) should be installed in different motor groups. Only in this way can the shades be controlled according to the position of the sun.

Motors can be kept in a secure position through the use of safety contacts (multifunction inputs). Note that a safety contact is *not* suitable for preventing collisions (e.g. if an awning has been installed above a window).

The device works at 230 V AC 50 Hz, the power consumption depends on the number and power of the connected motors.

For version **WS1000 Connect** (for 230 V motors) each motor output can be loaded with max. 400 Watts. The total installed power must not exceed approx. 1.5 kW, however. The output voltage is 230 V AC.

For version **WS1000 Connect-PF** (with potential-free motor outputs), each relay may be loaded with max. 5 A / 230 V.

Note whether a group control relay is prescribed by the motor manufacturer if motors are switched in parallel. Group control relays can be purchased from Elsner Elektronik of the motor manufacturer. Different blind and awning motors in particular can mostly only be operated via a group control relay at an output channel.



ATTENTION

Damage due to parallel switching of unsuitable motors!

Not all drives are suitable for parallel switching in drive groups.

- Use suitable motors or connect motors via a group control relay.

Motors with a power input exceeding 400 watt must be operated through a relay or contactor with its own power supply.

For direct current motors, we offer corresponding power supply units. If necessary, please state the motor type, manufacturer and – if applicable – the technical data.

Connect device to multifunction outputs

Heating, air-conditioning, lights, fans, gutter heaters, dimmers or alarm devices (e.g. alarm system in combination with motion sensors at one multifunction input) can be connected to the multifunction outputs).

The multifunction outputs have a potential-free closer contact that can be loaded with 230 V AC/2 A.

Connect device to multifunction inputs

Devices with potential-free contacts can be connected to the multifunction inputs. These can be devices for alarms, such as motion detectors or smoke detectors (with relay output) or a different device with potential-free contact which is critical for the alarm function.

**ATTENTION**

A smoke detector at a multifunction input does not fulfil the requirements of a smoke and heat extractor (RWA system).

- In buildings where RWA is required, use an approved system.

A heater or air-conditioning unit can be operated as an air-conditioning alarm independently of the Control System can be connected to a multifunction input with its potential-free contact. Through the closed relay, the device signals the Control System that it is currently heating or cooling and the control activates the ventilation block.

A closed contact on the multifunction input can be used to test if a sliding door is closed.

An initiator for the automatic reset can also be connected here, e.g. a button or an alarm (impulse when set).

Connect hand button

Mechanical single or double buttons can be connected to the hand button inputs, which are assigned to motors and devices in the menu.

**ATTENTION**

A fixed bridging of the "Up" hand button input does not guarantee that a motor remains in the safe position.

- Use a multifunction input with configuration "safety contact" in order to keep motors in the safe position.

Connect motors and devices wirelessly with the Control System

The wireless connection of devices and motors uses the Elsner radio module (e.g. RF relay, RF-MSG motor controls, RF-L dimmer). Elsner Elektronik fans can be taught to the Control System without an additional device. Please note the installation instructions enclosed with the radio modules and fans.

5.1.4. Wireless connections, Page 78

4.3.2. Start Control System



ATTENTION

Damage to device due to short circuit!

Moisture in the device can cause a short-circuit, e.g. condensation that forms if the device is brought from a cold room to a warm one.

- If necessary, dry before commissioning.

After installation, cabling and check of all connections, switch on the mains power.

The Control System starts and first of all the model (WS1000 Connect) and operating system (Android) are displayed. When the Control System has fully booted, the Control System is in the output position with weather data display. Weather data is displayed as soon as the Control System receives data (light intensity, direction and height of the sun, precipitation, wind, temperature).

Error messages can be displayed on the start page, which hide the weather data display, for example if the weather station is defective or not connected.

Meldungen zu aktivem Alarm werden durch die entsprechenden rote gefärbten Icons auf der Manuell-Seite des betroffenen Antriebs oder Geräts angezeigt, zum Beispiel bei Windalarm oder Regenalarm., Page 110

The time is displayed automatically if the time/date are received (by GPS signal). Otherwise, the time can be set manually.

- System > Set up WS1000 > Settings > Time and date
- 5.2.1. Settings > Enter time and date manually, Page 92

The time zone must always be input manually.

- System > Set WS1/1000 > Settings > Time zone
- 5.2.1. Settings > Select time zone, Page 94

The location is received automatically by GPS. Otherwise the location can be entered manually.

- System > Set up WS1/1000 > Settings > Location
- 5.2.1. Settings > Enter location, Page 94

4.3.3. Check function of the sensors

The current values for sun, wind and outside temperature are shown on the display. First check the function of the sensors.

Light intensity (sun sensor):

The sun sensor is located under the lid of the weather station. If the current brightness is not sufficient, illuminate the weather station with a powerful torch until a value is displayed.

Direction and height (sun):

Direction and height of the sun are calculated by the Control System from the date/time and location. The time is set automatically when a time signal is received (can take up to 10 minutes). The time can be set manually if the signal is not strong enough. If a weather station with GPS receiver is connected to the Control System, the time zone has to be set in the menu.

- ☐ System > Set up WS1000 > Settings > Time and date
- 📖 5.2.1. Settings > Enter time and date manually, Page 92
- ☐ System > Set up WS1000 > Settings > Location
- 📖 5.2.1. Settings > Enter location, Page 94

Precipitation (Precipitation sensor):

Precipitation is shown in the display by the animation "Rain" or "Snow". Moisten the golden sensor surface on the lid of the weather station (often the moisture on the skin when touching the sensor surface is sufficient). The animation "Precipitation" should then start.

Please note that the precipitation message remains for 5 minutes after the sensor is dried.

Wind speed (wind sensor):

If the sensor tube on the bottom of the weather station is blown into, the corresponding speed in metres per second is displayed next to the animated wind sock.

Temperature:

The outside temperature is displayed next to the "Thermometer next to a house" icon. If plausible values are displayed, it can be assumed that it is working properly.

If the radio indoor sensor is taught, the values are displayed next to the "Thermometer in the house" icon. rF displays the relative humidity, normal values are approx. 25% rF to 65% rF in living rooms. After installation, the hygrometer may need several hours before normal values are displayed.

5. Basic setting

5.1. The "Installation" menu

□ System > Installation

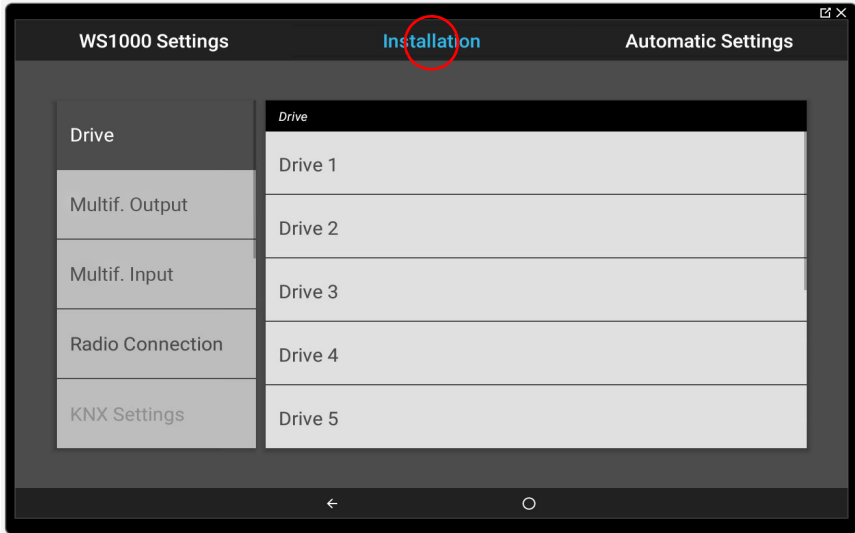

You can make the following settings in the menu area **System > Installation**:

- Input basic properties of the motors and devices at the inputs/outputs
- Assign wall switches
- Set up group switches and scenes for the manual menu
- Teach radio connections to devices
- Weather data
- Set up the start page and the manual menu
- Set up presence simulation

To do this, use the following submenus:

- Motor (with the possible settings Type, Name, Direction of rotation, Manual direction, Movement time, Canvas tightening, MSG controls, Display in manual menu, Safety contact)
- External keys (with the possible settings Type, Direction, Name, and Allocation to motor groups)
- Internal keys/group keys (with the possible settings Type, Name, Display in the manual menu, and Allocation to motor groups)
- Multifunction output (with the possible settings Type, Name, Display and he manual menu)

- Multifunction input (with the possible settings Type, Name, and Status display)
- Scene (with the possible settings Name, Display in the manual menu, and Allocation to motor groups)
- Radio connection
- Weather data (adjustment of the temperature display on the weather station and selection of the indoor sensor for the weather data display)
- Start page (channel sequence and bookmark management)
- Manual page (channel sequence and bookmark management)
- Presence simulation (with the possible settings Name, Display in the manual menu, and Configuration)

To be able to make the basic settings, the Control System must be installed correctly and commissioned.

 4. Installation and commissioning, Page 63

5.1.1. Set motors and motor groups

Windows, awnings and blinds are controlled in different ways. For example, windows are opened or closed depending on the temperature or humidity, but blinds depending on light and time. For this reason, the motor outputs must be adjusted correspondingly when the Control System is commissioned.

System > Installation > Motors

Select the motors (or motor groups) used from the list on the right and set them one after the other. If no settings are made, the fields show **Motor 1**, **Motor 2** etc. If an output has already been configured, the name of the motor is displayed instead.

Type of output:

Shows what is connected to the output. Touch the field and select:

- Reserve (unused)
- Awnings
- Windows
- Blinds
- Shutters

You can check the motor function with the keys **A** and **B**. Please also calculate the **actuation times** to fully open/extended or closed/retracted (stopwatch). For slatted blinds, also calculate the reversing time, i.e. the time the slats take to turn completely from "closed" to the other limit stop. You need the values for the setting "Actuation times" (see below).



ATTENTION

Rain and wind alarms are deactivated while this menu item is displayed.

Name:

Shows the name of the output. Touch the field and enter the desired name using the keyboard that appears.

Direction of rotation:

Shows whether the motor retracts/closes when key A or B is pressed. Touch the field to adjust the direction of rotation.

Test the behaviour of the motor by pressing the buttons **A/B**. Select **Retracts for A** (or **Closes for A**) or **Retracts for B** (or **Closes for B**).

**ATTENTION**

Rain and wind alarms are deactivated while this menu item is displayed.

Manual direction:

Shows whether the motor retracts/closes or extends/opens when "Arrow up" is pressed. Touch the field in order to adjust the assignment of the arrow keys (up/down, open/close).

Select whether the motor should **Retract** (or **Open**) or **Extend** (or **Close**) when the "Arrow up" key is pressed.

Actuation time:

Shows the retraction/extension time or opening/closing time, as well as the reverse time (blinds), zero position actuation time and dead time. Touch the field and enter the calculated actuation times in seconds (see "Type of output" above). Touch the time and change it using the keypad that is displayed.

The **zero position actuation time** defines how far the motor is extended after retracting (zero position). With this, the cable pulls of blinds can be loosened, for example (e.g. value 0.1 s). The **dead time** describes how long an electronic drive needs to actually start the motion once the control relay has been closed. Specifying the dead time allows a more precise positioning of the motor, e.g. if slats are tracking the position of the sun. Please adhere to the specifications from the motor manufacturer.

Canvas tightening (awnings):

Shows whether canvas tightening is active. Touch the field to select whether the awning canvas is to be tightened after reaching the movement position. This function may only be activated if the installed awning is suitable for this! The actuation time for canvas tightening is 1 second.

Slat turning (blinds):

Shows whether and in what case the slats are turned. Touch the field to set the slat turn.

Slat turning is recommended, for example, for blinds that are installed in a internal gap. Slats can remain hanging against each other when the curtain is moved. The slats are sorted and moved to the zero position as a result of the turning.

Never: Setting for most indoor and outdoor blinds.

For shades: Slats are only turned for automatic shading.

After every movement: Slats are turned with automatic shading, night and timed closing, and with manual closing without stop (end position).

Slats are generally only turned after the blinds are extended. They are *not* turned at a manually extended interim position.

MSG controls:

Shows whether motor control devices are controlled with the output. Touch the field if the output should be used as a central command unit for motor control devices and select **Yes**. The output relay then remains permanently closed if there is a rain or wind alarm.

If an individual motor or a group of motors is connected to the motor output, keep the default setting of **No**.

For windows where "MSG Controls Yes2 is selected, the function "Gap ventilation if there is rain" is no longer possible.

📖 3.2. Set automatic window controls

Manual menu:

Shows whether the motor is displayed in the manual menu and in the start menu. Touch the field and make your selection. Default: Display in manual mode Yes, in start menu No.

The display in the start menu is below the menu items "System" and "Manual menu".

The display sequence and other representation options can be set in the menus

📖 System > Installation > Start page or manual menu

📖 5.1.8. Start page, Page 87

📖 Building on automatic:, Page 88

Safety contact:

Shows which safety contact the motor output is assigned to. Touch the field and select the desired multifunction input configured as safety contact.

The contacts are connected to the MF inputs. If the safety contact is open, the motor moves to the safe position (window closes, shades retract) and manual operation is blocked.

Tips on connecting windows

With windows the supply of fresh air can be very well regulated using the Step window configuration. In this, the control unit checks the room temperature every 3 minutes. If the temperature is close to the reference value, the window will be opened or closed step by step. You can adjust the number of steps in the Automation menu ("Number of steps" button).

For sliding roofs, during normal operation of ventilators, it is not necessary to use the full stroke. For that reason you can adjust the size of the opening in the Automatic menu ("Movement position" button). If the sliding roof should be opened fully, this can take place manually.



ATTENTION

Material damage due to use of step/sliding roof operation with inappropriate window motors!

Not all window motors are suitable for step/sliding mode.

- Use this functions only with motors that are qualified for step/sliding operation by the manufacturer.

5.1.2. Set multifunction outputs

Switchable and dimmable devices can be connected to the multifunction outputs: Light and dimmer, heaters (also gutter heaters), air-conditioning and ventilation devices, and alarms

□ System > Installation > Multif. output

Select the outputs used from the list on the right and set them one after the other. Until the settings have been entered, the fields show **Multif. Output 1...4**. If an output has already been configured, the function or name is displayed instead.

Type of output:

Shows what is connected to the output. Touch the field and select:

- Reserve (unused)
- Heating
- Dimmer
- Air-conditioning unit
- ventilation
- Light
- Gutter
- Alarm

You can test the relay function with the key **Close**.

Name:

Shows the name of the output. Touch the field and enter the desired name using the keyboard that appears.

Manual menu:

Shows whether the output is displayed in the manual menu and in the start menu. Touch the field and make your selection. Default: Display in manual mode Yes, in start menu No.

The display in the start menu is below the menu items "System" and "Manual menu".

The display sequence and other representation options can be set in the menus

System > Installation > Start page or manual menu

 5.1.8. Start page, Page 87

 Building on automatic:, Page 88

Safety contact (ventilation):

Shows which safety contact the output is assigned to. Touch the field and select the desired multifunction input configured as safety contact.

The contacts are connected to the MF inputs. If the safety contact is open, exhaust/circulation air units are then switched off, supply air units are opened and manual operation is blocked. The safety provisions for fireplaces dependent on room air, for example, can be implemented with this.

5.1.3. Set multifunction inputs

Alarms (motion or smoke detectors) can be connected to the multifunction inputs, along with air-conditioning alarms (e.g. an air-conditioning unit/heater independent of the Control System), safety contacts, closed contacts (for sliding doors) and switches for the automatic reset.

If the **motion detector alarm** and a detected sensor signal are activated, all windows connected to the Control System are closed. "Motion alarm message" is displayed on the start page. After 5 minutes without a new sensor signal, the Control System returns to normal operation.

The **fire alarm from a smoke detector** activates various safety measures: Awnings, blinds and shutters retract in order to clear escape routes, lights go on, heaters and air-conditioners switch off, windows and ventilators are opened or switched on. During the fire alarm, an acoustic warning signal is emitted by the Control System. The fire alarm can only be switched off by a reset/restart of the Control System in the menu **System > Set up WS1000 > Service > Reset** or by disconnecting the power supply.

 6.4. Alarm and error messages > Smoke alarm, Page 106

A **heater or air-conditioning unit (air-conditioning alarm)** operated independently of the Control System can be connected to a multifunction input with its potential-

free relay contact. Through the closed relay, the device signals the Control System that it is currently heating or cooling. The Control System then closes all the windows and switch off the fans. If the device opens the relay contact again, the Control System keeps the windows closed for a set period and keep the fans off.

📖 3.2.4. Adjust ventilation lock (air-conditioning unit), Page 35

A **safety contact** can be connected to the multifunction inputs, which is then allocated to a motor output. If the safety contact is open, the motor moves to the safe position (window closes, shades retract) and manual operation is blocked.

With this it is possible, for example, to prevent blinds in front of a terrace door not to be lowered if the door has been opened. A safety contact is *not* suitable for preventing collisions (e.g. if an awning has been fitted above a window)/

The safety provisions for fireplaces dependent on room air can be implemented with this.

The multifunction inputs can be used as triggers for the **automatic reset**. The input impulse can come from a button or by setting the alarm system, for example.

☐ System > Installation > Multif. Input

Select the inputs used from the list on the right and set them one after the other. Until the settings have been entered, the fields show **Multif. Input 1...4**. If an input has already been configured, the function or name is displayed instead.

Type of input:

Shows what is connected to the input. Touch the field and select:

- Reserve (unused)
- Motion detector
- Smoke detector
- Air-conditioning alarm (e.g. an air-conditioner/heater independent of the Control System).
- Safety contact
- Automatic reset

Name:

Shows the name of the input. Touch the field and enter the desired name using the keyboard that appears.

Status of the input:

Shows whether the relay is currently open or closed.

5.1.4. Wireless connections

Devices, which communicate wirelessly with the Control System, first have to be taught to the Control System.

When teaching, always note the datasheet of the respective radio participant. The indoor sensor supplied is also a radio participant and must be taught.



WARNING!
Electric voltage!

For some devices, the programming key for teaching the wireless connection is located inside the housing and thus near unprotected live components.

- Only skilled electricians (pursuant to VDE 0100) may teach-in such devices.

System > Installation > Radio connection

Teach:

Touch the field to make the Control System ready to learn. Then follow the instructions for the corresponding radio participant (press PROG key or switch on power supply). For radio participants, for which the power supply must be switched on, you can switch on the supply for all devices simultaneously. The radio participants automatically learn in order. For radio participants, for which the PRG key must be pressed, you can teach all participants directly in order.

As soon as the wireless connection has been created, the Control System reports how many devices have just been learned and lists the individual modules.

Status:

Touch the field to see which wireless connections already exist and to configure the individual devices. If no settings have been made, the radio participants are named as the devices. The assigned names are displayed later in the keys.

Different operating data is displayed for the devices;

Sensors *WGTH-UP (gl)*, *WG AQS/TH (gl)* and *WGT*:

Radio Module Type	Display "WGTH" or "WG AQS/TH" or "WGT". Display serial number, version and RF router used
Radio Status	Displays Radio Status
Name	Shows the name. Touch the field and enter the desired name using the keyboard that appears.

Manual menu	Shows whether the radio participant is displayed in the manual menu and in the start menu. Touch the field and make your selection.
Adjust	Shows the measured and displayed values. Touch the field to adjust the values displayed. It may be necessary to correct the measured values if the temperature/humidity at the sensor does not correspond to the room average (e.g. if the sensor is installed above an above-average warm location).

Remote control Remo pro/8:

Radio Module Type	Display "Remo 8/ Remo pro". Display serial number and RF router used, if applicable
Name	Shows the name. Touch the field and enter the desired name using the keyboard that appears.
Motor groups	Touch the field to allocate motors and devices to the remote control channels. Touch the field to perform the allocation.
	ATTENTION! Only drives/devices that have the same function should be operated together by one manual transmitter channel (e.g. only blinds or only windows).

Corlo P RF key:

Radio Module Type	Display "Corlo RF P1" or "Corlo RF P2" Display serial number, version and RF router used
Key type	Shows how the key is configured. Touch the field and select: Corlo P1 RF <ul style="list-style-type: none"> • Change key • On key • Off key Corlo P2 RF <ul style="list-style-type: none"> • Double key • 2x single keys with configuration each as change, on or off key
Name	Shows the name. Touch the field and enter the desired name using the keyboard that appears.
Motor groups	Shows which motor or device is controlled by the key. Touch the field to perform the allocation. If necessary, select the key (right/left).
	ATTENTION! Only drives/devices that have the same function should be operated together with one key (e.g. only blinds or only windows).

RF-B2-UP key interface:

Radio Module Type	Display "RF-B2-UP" Display serial number, version and RF router used
Key type channel 1/2	Shows how the channel is configured. Touch the field and select: <ul style="list-style-type: none"> • Double key • 2x single keys with configuration each as change, on or off key
Name	Shows the name. Touch the field and enter the desired name using the keyboard that appears.
Motor groups	Touch the field to allocate motors and devices to the key channels. Touch the field to perform the allocation.
 ATTENTION!	Only drives/devices that have the same function should be operated together with one key (e.g. only blinds or only windows).

Roof ventilator WL400, WL800:

Radio Module Type	Display "WL400/800" Display serial number, version and RF router used
Radio Status	Displays Radio Status
Name	Shows the name. Touch the field and enter the desired name using the keyboard that appears.
Manual menu	Shows whether the radio participant is displayed in the manual menu and in the start menu. Touch the field and make your selection.
Adjust	Shows the measured and displayed temperature value. Touch the field to adjust the value displayed. It may be necessary to correct the measured value if the temperature at the sensor does not correspond to the room average (e.g. if the sensor is installed above an above-average warm location).
Safety contact	Shows which safety contact the ventilator is assigned to. Touch the field and select the desired multifunction input configured as safety contact. The contacts are connected to the MF inputs. If the safety contact is open, exhaust/circulation air units are switched off and manual operation is blocked. The safety provisions for fireplaces dependent on room air, for example, can be implemented with this.

WL-Z supply air unit:

Radio Module Type	Display "WL-Z" Display serial number, version and RF router used
Radio Status	Displays Radio Status

Name	Shows the name. Touch the field and enter the desired name using the keyboard that appears.
Manual menu	Shows whether the radio participant is displayed in the manual menu and in the start menu. Touch the field and make your selection.
Safety contact	Shows which safety contact the ventilator is assigned to. Touch the field and select the desired multifunction input configured as safety contact. The contacts are connected to the MF inputs. If the safety contact is open, supply air units are opened and manual operation is blocked. The safety provisions for fireplaces dependent on room air, for example, can be implemented with this.

RF-VM fan module:

Radio Module Type	Display "RF-VM" Display serial number, version and RF router used
Radio Status	Displays Radio Status
Type of Automatic	Shows the type of automatic controls. Touch the field and select: <ul style="list-style-type: none"> • Incoming air/exhaust air • Fresh air/heat
Name	Shows the name. Touch the field and enter the desired name using the keyboard that appears.
Manual menu	Shows whether the radio participant is displayed in the manual menu and in the start menu. Touch the field and make your selection.
Safety contact	Shows which safety contact the ventilator is assigned to. Touch the field and select the desired multifunction input configured as safety contact. The contacts are connected to the MF inputs. If the safety contact is open, exhaust/circulation air units are then switched off, supply air units are opened and manual operation is blocked. The safety provisions for fireplaces dependent on room air, for example, can be implemented with this.

Relay RF-relay, RF-heating, Heatstrip radiator:

Radio Module Type	Display "RF-Relay" Display serial number, version and RF router used
Radio Status	Displays Radio Status

Type of automatic controls (only for RF relay)	Shows the type of automatic controls (connected to the radio module). Touch the field and select: <ul style="list-style-type: none"> • None • Heating • Air-conditioning unit • Ventilation • Light • Gutter heating • Alarm • Dimmer. If "Dimmer" or "None" is selected, the device can only be operated manually, there are no automatic menus.
Name	Shows the name. Touch the field and enter the desired name using the keyboard that appears.
Manual menu	Shows whether the radio participant is displayed in the manual menu and in the start menu. Touch the field and make your selection.

Motor control unit RF-MSG:

Radio Module Type	Display "RF-MSG" Display serial number, version and RF router used
Radio Status	Displays Radio Status
Type of Automatic	Shows what is connected to the radio module. Touch the field and select: <ul style="list-style-type: none"> • Reserve (unused) • Awnings • Windows • Blinds • Shutters
Name	Shows the name. Touch the field and enter the desired name using the keyboard that appears.
Manual menu	Shows whether the radio participant is displayed in the manual menu and in the start menu. Touch the field and make your selection.
Other settings	The other possible settings for the individual motor types correspond to those for the cable-connected motors  5.1.1. Set motors and motor groups, Page 73

Dimmer RF-L:

Radio Module Type	Display "RF-dimmer" Display serial number, version and RF router used
Radio Status	Displays Radio Status
Name	Shows the name. Touch the field and enter the desired name using the keyboard that appears.

Manual menu	Shows whether the radio participant is displayed in the manual menu and in the start menu. Touch the field and make your selection.
Min. dim value	Shows the minimum dim value for manual dimming. Touch the field and adjust the value using the slider. For automatic mode, values can be set here that are outside the set dimming range.
Max. dim value	Shows the maximum dim value for manual dimming. Touch the field and adjust the value using the slider. For automatic mode, values can be set here that are outside the set dimming range.
Switch-on behaviour	Shows what happens when switching on Touch the field and select a whether the <ul style="list-style-type: none"> • On dim value • Last value should be dimmed when switching on. You can define the ON dim value in the next setting.
ON dim value (only if an ON dim value is used when switching on)	Shows the dim value when switching on manually. Touch the field to adjust the value using a slider.

RF-Router:

The RF router forwards the radio signal to other radio participants if the radio route is to long for a direct connection.

Radio Module Type	Display "RF-Router" Display of serial number, version
Radio Status	Displays Radio Status
Name	Shows the name. Touch the field and enter the desired name using the keyboard that appears.
Router channels	Touch the field to allocate a radio participant to each of the respective 16 router channels. Touch a channel and select which radio participants should be connected to the channel.

Delete:

Touch the field to delete the connection to the individual radio participants. All existing radio modules are displayed. Touch a radio participant and confirm the deletion.

Radio activity in the 868.2 MHz band:

Shows the radio capacity utilisation The higher the percentage, the more radio traffic on the band.

5.1.5. Allocate external keys

If external keys are installed locally for operating motors and devices, the settings and allocations are made here. 10 connections are available for keys. **Single keys** (toggle keys) or **double keys** (unlocked series keys) can be connected to these and configured.

□ System > Installation > Ext. keys

Select the keys used from the list on the right and set them one after the other. Until the settings have been entered, the fields show **Ext. keys 1...10**. If a key has already been configured, the function or name is displayed instead.

Type of key:

Shows the set key function. Touch the field and select:

- Reserve (unused)
- Change key (for single keys).
Switches with every press of the key. Dim by holding the key.
- Up/down key (for unlocked double keys).
For motor (shades, windows): Timer, i.e. short push of the button with dead man principle, longer push of the button (> 1 second) with self-retention for moving to the end position.
For switchable device (lighting, heating, etc.). Up key switches on, down key off.
- OFF key
- ON key

Key direction (up/down keys):

Shows whether the key direction is normal or reversed. Touch the field to check the direction and change it if necessary.

Press the up and down key of the button. The arrow shown in the display is activated. If the direction of the key corresponds to the display, leave the setting **Normal**. Otherwise, press the key **reversed**. Now the key and display would have to agree.

Name:

Shows the name of the key. Touch the field and enter the desired name using the keyboard that appears.

Motor groups:

Shows which motors/devices are allocated to the key. Touch the field and select the motor group or a device.

Only one device can be allocated to a single key (change/on/off), multiple motors or devices can be allocated to a double key (up/down).

**ATTENTION**

Only drives/devices that have the same function should be operated together with one key (e.g. only blinds or only windows).

5.1.6. Allocate internal keys (group keys)

In manual mode, multiple motors or devices can be operated simultaneously via one joint group key (internal software key). 20 internal keys are available.

System > Installation > Int. keys

Select the individual keys from the list on the right and set them one after the other. The fields show **Int. keys 1...20** until settings have been entered. If a key has already been configured, the function or name is displayed instead.

Type of key:

Shows the set key function. Touch the field and select:

- Reserve (unused)
- Int. key

Name:

Shows the name of the key. Touch the field and enter the desired name using the keyboard that appears.

Manual menu:

Shows whether the group key is displayed in the manual menu and in the start menu. Touch the field and make your selection.

The display on the start page is below the menu items "System" and "Manual menu".

The display sequence can be set in the menus

System > Installation > Start page or manual menu

5.1.8. Start page, Page 87

Building on automatic:, Page 88

Motor groups:

Shows which motors/devices are allocated to the group key. Touch the field and select the motor groups or a device.

**ATTENTION**

Only drives/devices that have the same function should be operated together with one key (e.g. only blinds or only windows).

5.1.7. Scenes

In scenes, you define the status of various motors and devices so that they can then be accessed with just one push of a button. You can also specify, for example, that the light should be dimmed and the shutters closed at the same time, and save this as "TV evening" scene.

16 scenes are available in the **WS1000 Connect Control System**.

System > Installation > Scenes

Select a scene from the list on the right and set it. The fields show **Scene 1...16** until settings have been entered. If a scene has already been configured, the name is displayed instead.

Name:

Shows the name of the scene. Touch the field and enter the desired name using the keyboard that appears.

Manual menu:

Shows whether the scene is displayed in the manual menu and in the start menu. Touch the field and make your selection. Default: Display in manual mode Yes, in start menu No.

The display in the start menu is below the menu items "System" and "Manual menu".

The display sequence and other representation options can be set in the menus

System > Installation > Start page or manual menu

 5.1.8. Start page, Page 87

 Building on automatic:, Page 88

Motor groups:

Shows which motors/devices are allocated to the scene. Touch the field and select the motor groups or a device.

Touch each individual motor that should be included in the scene and set the movement position. Set the status for each device, e.g. On or Off.

5.1.8. Start page

Favourites and bookmarks are displayed on the left of the start page. You can set different display options here.

System > Installation > Start page

Display sequence:

Touch the field to specify the display sequence of the favourites and bookmarks. All entries are shown in a list. Hold an entry by the list symbol on the right and move it to the desired position.

So that a motor is displayed as favourite, the setting "Start page" at the "Manual menu" item has to be activated.

System > Installation > Motor/Multif.output > Manual menu

Bookmarks:

The browser allows you to bookmark up to 50 web pages.

Change name:

Touch the field to change the name of the bookmark. Select the bookmark from the list, touch it and enter a name.

Delete bookmarks:

Touch the field to delete a bookmark. Select the bookmark from the list and confirm the deletion.

Building on automatic:

Select here whether the "Building on automatic" function is to be displayed on the start page.

With this function, all drives and lights for which an automatic reset has been set are put back into automatic mode.

5.1.9. Manual page

The menu item "Manual menu" is on the left side of the start page. This manual page shows motors and devices for manual operation.

System > Installation > Manual page

So that a motor or device is displayed in the manual menu, the setting "Manual menu" has to be activated in the installation settings.

System > Installation > Motor/Multif.output > Manual menu

Display sequence:

Touch the field to specify the display sequence in the manual menu. All entries are shown in a list. Hold an entry by the list symbol on the right and move it to the desired position.

Subject groups:

Touch the field to create subject groups.



As soon as a subject group has been activated, motors and devices are no longer displayed in the manual menu!

All groups are shown in a list. Hold an entry by the list symbol on the right and move it to the desired position.

Activate the groups you want to use by touching the check box. A pencil icon appears, which touch to edit the group.

- All visible channels (no selections possible)
- Central function (scenes, group keys)
- Room controls (heating, air-conditioning)
- Floors (all functions)
- Output (motors, multifunction outputs, group keys)
- Input (sensors)

You can activate, sort and edit additional subgroups in each group.

Name:

Shows the name of the subgroup. Touch the field and enter the desired name using the keyboard that appears.

Symbol:

Shows the selected symbol for the subgroup. Touch the field and select a symbol from the list.

Allocate channels:

Touch the field and select the functions to be added to the group. Only the functions that go with the subject are displayed for each group.

Display sequence:

Touch the field to specify the display sequence of the selected channels. All entries are shown in a list. Hold an entry by the list symbol on the right and move it to the desired position.

5.1.10. Weather display

The current data supplied by the weather station and indoor sensor is displayed on the start page. The displayed temperature of the weather station can be adjusted. If multiple temperature sensors are installed, select the sensor here, whose data should be displayed on the start page.

System > Installation > Weather display

Outdoor temperature:

Touch the field to set the sensor for the outdoor temperature. If the weather station is selected, you can adjust the displayed temperature value here. This adjusted value is also used for the Control System!

You can adjust the radio sensors in the menu

System > Installation > Radio connection

 Sensors WGT-UP (gl), WG AQS/TH (gl) and WGT:, Page 79

Indoor temperature:

Shows which sensor is used for the weather data supply on the start page. If several sensors are installed, touch the field to select the desired sensor.

5.1.11.Presence simulation

You can call up to 16 events with the presence simulation simultaneously or consecutively, to give the appearance that people are in the building. A settable delay for the start time makes the simulation more realistic.

System > Installation > Presence simulation

Name:

Shows the name of the presence simulation. Touch the field and enter the desired name using the keyboard that appears.

Manual menu:

Shows whether the presence simulation is displayed in the manual menu and in the start menu. Touch the field and make your selection.

Default setting: Display in manual mode "Yes", in start menu "No".

The display in the start menu is below the menu items "System" and "Manual menu".

The display sequence and other representation options can be set in the menus

System > Set screen > Start page or manual page

 5.1.8. Start page, Page 87

 Building on automatic:, Page 88

Configuration:

Touch the field to configure the presence simulation.

Select an event from the list and apply it. If no settings have been made, the fields show **Event 1...16**. If an event has already been configured, the function is also shown underneath.

Three conditions can be defined, when an event should start, e.g. when a motor (blind or shutter) is extended/retracted or when a light is switched on or off.

- Time: Event starts at specific time
- Time and brightness: Event starts if a set brightness is undercut in a defined period.
- Event X: Event starts as soon as Event X has started

With a random delay, a range can be set, from which a value is selected at random. The start time of an event is delayed by this value.

The motor / light is selected with the "Select function" button.

5.2. Set up WS1000

□ System > Set up WS1000

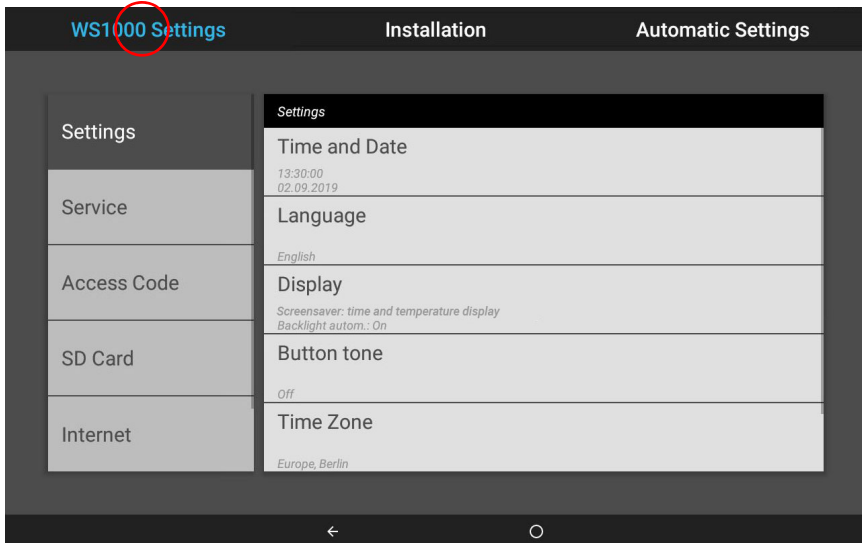
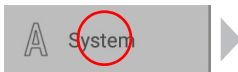

You can make the following settings in the menu area **System > Set up WS10000**:

- Change individual data such as time/date and time and match the screen display to your personal desires (settings)
- Activate the cleaning mode, restart the Control System, reset to factory settings, change internal settings and start remote maintenance (service)
- Set an access code to protect the menus "Installation" and "Set-up automatic" against unauthorised change (access code)
- Save the setting details for the Control System on SD card or read from SD card (SD card)
- Set up the internet/network connection (internet)

- Load updates and check the software versions of the Control System (device information)

5.2.1. Settings

You can make the following settings in the menu area **System > Set up WS10000 > Settings**:

- Time and date
- Language
- Display
- Key tone
- Time zone
- Location

Enter time and date manually

Date and time are displayed in the top right of the start page. Normally the data is received by the weather station via GPS. It is mostly received within approx. 10 minutes of the system starting. If there is no time signal, set the clock manually.

Time and date:

Shows the current time and date. Touch the field to enter the data manually.

Change language

The display can be set to German, English, French and Italian.

Language:

Shows the currently selected language. Touch the field to select a different language.

Set up screen

The **WS1000 Connect** can display picture file, time/temperature as a screen saver or simple a black screen. The screen saver is activated if the display has not been touched for 5 minutes.

Additionally, the display brightness can be adjusted automatically to the room brightness and the screen can switch off when dark.

Display:

Shows which screen saver is currently active and whether automatic brightness is switched on. Touch the screen to see the menu.

Screen saver:

Select the screen saver:

- Without

- Black screen
- Time and temperature display
- Pictures from SD card. "Slide show" or "Single picture" can be selected for the picture display. The "Slide show" shows all pictures on the SD card one after the other. With "Single picture", you can select the image from the SD card.

In order to show digital picture data as a slide show, save the files to a micro SD card. The picture files must meet the following requirements:

- The files must be saved in the highest directory level of the card (master directory)
- File format: Bitmap (BMP, without RLE compression), Jpeg (JPG), GIF or PNG (without transparency)
- For pictures with a page ratio other than 16:10, black bars are added at the top/bottom or right/left. The display has a resolution of 1280 × 800 pixels
- Colour intensity 24 bit or 16 bit

The card socket is located on the right-hand side of the device. The SD card is pushed into the slot, until it clicks into place. To remove, briefly press the card into the socket so that it jumps out.

If picture data is saved on the card, the "Slide show" key is displayed on the right of the upper menu bar, with which you can directly start it. The image changes approx. every 45 seconds (for images with 24-bit colour intensity). To interrupt the screen saver, touch the screen or remove the SD card.

Automatic switch-off:

With the automatic switch-off, you set whether the display lighting should be switched off when the room is dark. If no command is given for around 5 minutes when it is dark, the automatic switch-off darkens the screen again.

To do this, set the sensitivity of the brightness sensor. If the sensitivity is high, the control unit only switches off when the room is very dark. If the sensitivity is low, the room may still be relatively bright when the display lighting is switched off.

Default setting: "medium"

For the automatic switch-off, the central control unit of the **WS1000 Connect Control System** records the brightness. If it is bright in the room, the display lighting is automatically switched on. If the screen is touched, it also re-activates.

Automatic brightness:

The automatic brightness function adjusts the display screen to the light conditions in the room (the darker the room, the darker the display screen lighting). Touching the display screen increases the brightness by 30% in order to ensure excellent legibility. If no instructions are entered for around 1 minute, the screen brightness is reduced again.

If the automatic controls are off, the percentage screen brightness is set using a slider.

Switch key tone off/on

The key tone produced when a key is touched can be switched off and on again.

Key tone:

Shows whether the key tone is on or off. Touch the field to change the setting.

Select time zone

In order to be able to display the date and time, the time zone has to be set.

Time zone:

Shows the time zone currently set. Touch the field to change the setting.

The time zone can be entered "by location" or "user defined". Touch the field to switch between the options.

When selecting by location, choose the city from the list provided. For user-defined setting, enter the time zone based on GMT (Greenwich Mean Time).

Enter location

The location is received by the weather station automatically by GPS. If there is no GPS reception, set the location here.

The information on the location of the building is necessary in order to correctly indicate the position of the sun. If you do not provide this location data, the blinds will not be correctly controlled.

Location:

Shows the current location. Touch the field and select the location as **City** or as **coordinates** (longitude and latitude).

5.2.2. Service settings

You can make the following settings in the menu area **System > Set up WS10000 > Service**:

- Cleaning mode
- Reset (restart)
- Factory settings
- Internal area
- Remote maintenance

Cleaning mode

Touching the "Cleaning mode" menu item switches off the touch function of the screen for 60 seconds. During this period, the screen can be wiped with a damp cloth. Please

always use this function to clean the control unit, otherwise functions may be unintentionally triggered or adjusted by cleaning.

Reset (restart)

Reset starts the control system software again. The automatic settings are retained. After starting, the motors and devices, for which an automatic reset is set, are in automatic mode.

Reset:

Touch the key to restart the Control System.

Factory settings



ATTENTION

Damage due to incorrect use of the service functions!

The factory settings delete all settings made. There are no longer any automatic controls.

All basic and automatic settings are deleted by resetting to factory settings. The control system will be returned to its delivery condition.

Factory settings:

Touch the field if you want to reset the Control System to the delivery status. Enter code "81" and confirm. The factory settings are loaded and the Control System restarted. When resetting to factory settings, the backup file is also overwritten (See "Backup function:" on page 98.).

Internal area



ATTENTION

Property damage due to incorrect use of the internal area function!

The internal area is not needed in the normal function of the control system.

The internal area is only needed by the manufacturer's service and offers the option to change basic properties of the device.

Remote set up/remote maintenance

Access to the **WS1000 Connect Control System** is possible via the internet using the remote maintenance function. An internet connection is needed for this. A service technician can then see and change the settings without being on site.

 *Network connection (internet).*

Access to the Control System is only possible if remote maintenance is also started on the device. This is not a remote control option! If you want to operate the Control System and your building technology on the go, then use the WS1000 Connect App and set up a secure VPN connection for your home network.

Remote maintenance:

The automatic screen switch-off is deactivated during remote maintenance. Activate it again after the session, if required.

System > Set up WS1000 > Settings > Screen

Start remote maintenance software:

Touch the field to open the software. Follow the instructions. To create the connection, the device ID of the **WS1000 Connect** must be input at the PC used for the remote maintenance. Then every menu and function of the **WS1000 Connect** can be viewed and controlled from the PC.

Close remote maintenance software:

Touch the field to end the remote maintenance session.

5.2.3. Access code

In the menu area **System > Set up WS1000 > Access code** you can set up access codes in order to protect the Control System from unauthorised access. The menus "Set up WS1000", "Installation" and "Set-up automatic" can be protected.

Manual use of the Control System remains free at all times.

Access to the menus of the central unit:

Enter code:

Touch the field and enter the desired access code. The code is shown unencrypted. Confirm it. The Control System now requests this code as soon as the system menu is tapped on the start page.

If you have forgotten the current code, enter the code "123" and confirm by pressing the "OK" button for a long time (> 1 s).

Change code:

Touch the field and enter the existing code. Confirm, and enter the new access code. The control system will ask for this new code before displaying the menus.

Delete code:

Touch the field and enter the existing code. Confirm it and the Control System no longer have an access code. If you have forgotten the current code, enter the unlock code "123" in order to delete the code.

Access by App (via smartphone/tablet):

Shows whether an access code is needed for accessing the Control System by App. Touch the field and make your selection.

No, Do not allow access, prohibits any access by App to the Control System.

Access **without access code** allows free access. The control functions can be used with any smartphone, on which the App is installed and is connected to the same WLAN.

Access **with access code** allows App operation of the Control System only after a code has been entered. Enter the desired PIN number.

5.2.4. Using an SD card

The **WS1000 Connect Control System** can load data from a micro SD card. The SD card storage is needed for:

- Screen saver data
- Update files for software updates
- Saving settings (configuration file)

The card socket is located on the right-hand side of the device. The SD card is pushed into the slot, until it clicks into place.

To remove, briefly press the card into the socket so that it jumps out.



The card is automatically detected. If picture data is saved on the card, the "Slide show" key is displayed on the right of the upper menu bar, with which you can directly start it. The image changes approx. every 45 seconds (for images with 24-bit colour intensity). To interrupt the slide show, touch the screen or remove the SD card.

Information about possible picture information can be found in chapter Set up screen, Page 92.

Save and load configuration data

The SD card is also used as a storage and transmission medium for setting data (all settings in the menus "System", "Installation" and "Set Automatic"):

- for the automatic backup
- to save the personal settings, for example a summer and a winter configuration

Backup function:

The configuration data of the controller are automatically saved as a backup on the SD card supplied whenever changes are made (memory requirement approx. 5 MB). When resetting to factory settings, the backup file is also overwritten. Remove the SD card if you want to use the Configuration again later.

If you insert the SD card with the backup into a new/other device, you will be asked if you want to load the backup.

You can also select the file with the file name "Auto_ "Serial number"" in the menu area **System > System settings > SD card > Load/Restore backup** and thus load the automatically saved configuration data. The parameters are reloaded for this purpose.

Load config.:

Touch the field in order to view all the configuration files in the card's master directory. Touch an entry to load the file. The Control System is restarted.

Save config.:

Touch the field in order to save the setting data for the Control System on the SD card. Select an existing configuration from the list in order to save it. Or add a new configuration and enter the desired name it should be saved as.

Delete config.:

Touch the field in order to view all the configuration files in the card's master directory. Touch an entry to delete the file (deletion must be confirmed).

Show pictures on the display

The **WS1000 Connect** can display digitally saved picture data as a slide show or a single image. The picture data for this must be saved on an SD card.

Information about possible picture information can be found in chapter Set up screen, Page 92.

The sequence of the catalogue of individual images and of the slide show corresponds to the sequence in which the images were saved onto the card. The images are not sorted according to name.

To return to the start page, touch the screen or remove the SD card.

Slide show:

Touch the field to start the slide show. The images are displayed in the same sequence as they were saved onto the card (see note below). The image changes approx. every 45 seconds (for images with 24-bit colour intensity).

Single picture:

Touch the field if you want to display a single picture. All pictures saved on the card are displayed. Select the desired picture.

Internet

The **WS1000 Connect Control System** is internet-ready and can be connected to a network by cable (Ethernet/LAN) or WiFi (WLAN). The network connection is needed for:

- Use of Apps (with smartphones and tablets in the same network/WLAN)

If the **WS1000 Connect** is also connected to the internet via the internal network, the following functions are also possible:

- Accessing web contents in the Control System's browser
- Remote access (e.g. for system set-up, diagnosis)

The Ethernet/LAN connection terminal can be accessed after removing the display, without having to remove the touch protection (cover for 230 V power area). Note the information regarding assembly.

Connection status:

Shows the current status (disconnected or connected).

Connection type:

Shows the type of connection (Ethernet or WLAN). Touch the field to set up the connection.

WLAN: Wireless connection. If WLAN has been confirmed, the additional field "Network name" is displayed for the additional set up.

Ethernet: Cable connection via the LAN socket on the circuit board. No other settings necessary.

Network compatibility mode:

This menu item only appears if Ethernet/LAN is set for Connection type.

Shows whether the compatibility mode is activated.

The compatibility mode can be helpful in case of network problems. In this case, tap the field to activate the compatibility mode.

Network name (SSID):

The network is selected and set up here under the setting WLAN. Enter a network name or touch "Find networks" to view all available networks.

Create connection:

You can only "Create connection" using this touch field once a network has been selected. The password for the network is requested.

If necessary, use the same field to terminate the connection.



Protect your network with the latest encryption technology and change your passwords regularly!

Device information

The software for the **WS1000 Connect Control System** can be updated during normal operation. If the control is connected to the internet, the control downloads updates automatically after confirmation. Alternatively, you load the new software from the Elsner Elektronik website and save it to the SD card. After inserting the SD card into the socket on the **WS1000 Connect**, continue.

Check for updates:

Shows the currently installed version and facilitates the installation of SD card or the search for updates on the internet. Follow the download and installation instructions on the display.

Version history:

Shows the status of the version history of the Control System. Tap the field to display the version history of the **WS1000 Connect Control System**.

Manual:

Shows the status of the current Control System manual. Tap on the field to call up the individual chapters of the manual.

WS1000 Connect, display, connection boards, Elsner radio:

The current versions of the device are displayed.

6. Tables, plans, maintenance

6.1. Maintenance and care

Maintenance of the weather station

**WARNING!****Risk of injury caused by components moved automatically!**

The automatic control can start system components and place people in danger (e.g. moving windows/awnings if a rain/wind alarm has been triggered while cleaning).

- Always isolate the system from the mains for servicing and cleaning.

The device must regularly be checked for dirt twice a year and cleaned if necessary. In case of severe dirt, the sensor may not work properly anymore.

**ATTENTION**

The device can be damaged if water penetrates the housing.

- Do not clean with high pressure cleaners or steam jets.

Maintenance of the Control System

Abrasive / detergent cleaning agents and aggressive care products must not be used for cleaning. Remove fingerprints from the touchscreen ideally using a wet cloth or a microfibre cloth. Use the cleaning mode for this. This function locks the touch display

for 60 seconds and thus prevents functions from being triggered or adjusted unintentionally during cleaning.

☐ System > Set up WS1000 > Service > Cleaning mode

📖 Cleaning mode, Page 94

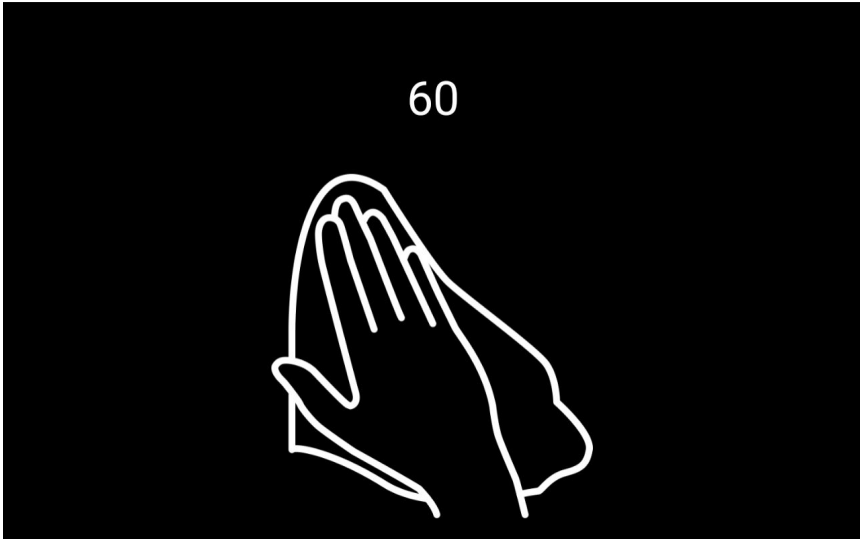

If there is a power outage, the data entered by you is saved for approx. 10 years. A battery is not needed for this. After the mains power has been restored, the clock is set automatically as soon as the weather station receives a time signal.

6.2. Units for sun and wind

The display of sun intensity is in lux or kilolux and is shortened in the display to lx or klx. The value 1 is reached even with overcast skies, 20 klx if the sun has just come out again and 100 klx is reached when there are cloudless skies at noon. Experience indicates that extending shades above 40 klx is to be recommended.

The display of wind speed is in meters per second and is shortened in the display to m/s. Depending on the position of the building and the installation position of the weather station, different values may be optimal in order to protect the shade or window. Observe the response of the awning or blinds or the window to wind and then correct the wind value accordingly.

The following table should make it easier to find the optimal values for your situation:

Description	m/s	km/h	Beaufort	Knots
Calm	< 0,3	< 1	0	< 1
Light air	0,3-1,5	1-5	1	1-3
Light breeze	1,6-3,3	6-11	2	4-6
Gentle breeze	3,4-5,4	12-19	3	7-10
Moderate breeze	5,5-7,9	20-28	4	11-16
Fresh breeze	8,0-10,7	29-38	5	17-21
Strong breeze	10,8-13,8	39-49	6	22-27
Moderate gale	13,9-17,1	50-61	7	28-33
Fresh gale	17,2-20,7	62-74	8	34-40
Strong gale	20,8-24,4	75-88	9	41-47
Whole gale	24,5-28,4	89-102	10	48-55
Storm	28,5-32,6	103-117	11	56-63
Hurricane	> 32,6	> 117	12	> 63

6.3. Disposal

After use, the device must be disposed of in accordance with the legal regulations. Do not dispose of it with the household waste!

6.4. Alarm and error messages

Messages about an active alarm are displayed by the corresponding, red icons on the manual page of the relevant motor or device, for example if there is a wind alarm or rain alarm.

 2.3.1. The manual menu > Info icons, Page 23

In addition, different alarm and error messages are shown on the start page:

Network error



If the LAN/Ethernet network connection is interrupted, a crossed-out network cable icon is displayed in the top right of the start page.

Check the function of the network and whether the cable is connected correctly.



If the network connection via WLAN is interrupted, a crossed-out radio symbol icon is displayed in the top right corner of the start page.

Check the function of the wireless network.

Alarm display in the weather data area

In the weather data area, the following alarm messages can be displayed as soon as an alarm is active.

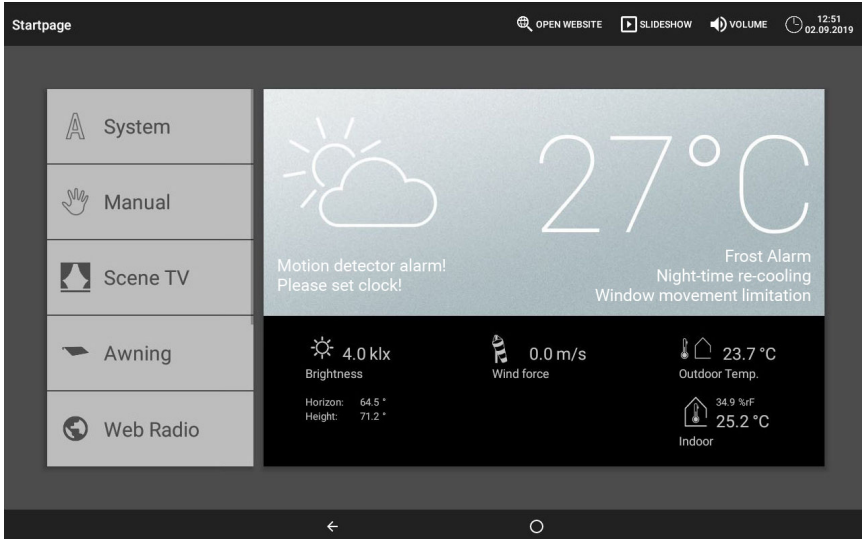

Motion detector alarm!

is displayed if a connected motion sensor has been activated. If there is a motion detector alarm, windows are automatically closed, if applicable the light is switched on. After 5 minutes without a new signal from the motion detector, the display disappears and the Control System switches the windows to the normal automatic mode again.

Please set the clock!

is displayed during commissioning or following a restart of the Control System. As soon as the weather station receives a time signal, this display disappears. If nothing is received, please set the clock manually.

- System > Automatic settings > General settings > Time and date
- Enter time and date manually, Page 92

Radio module defective!

means that the internal radio module is not working properly. Contact customer service in order to have the Control System checked.

Frost alarm

is displayed while the frost alarm is active (precipitation at low outside temperatures).

📖 3.2.6. Adjust frost alarm, Page 36

Night back cooling

is displayed while night back cooling is active.

📖 3.2.5. Set night back cooling (ventilation), Page 35

Window movement limit

is displayed while the window movement limit is active (low outside temperature over a longer period).

📖 3.2.7. Set movement limit (windows), Page 37

Smoke alarm

If there is an alarm from a connected smoke detector, the Control System emits a warning tone and a fire symbol is displayed on the start page. At the same time, awnings and blinds retract, heaters and air-conditioning units switch off, windows and ventilators open/switch on. Manual operation is blocked. The fire alarm can only be switched off by a reset/restart of the Control System in the menu **System > Set up WS1000 > Service > Reset** or by disconnecting the power supply.

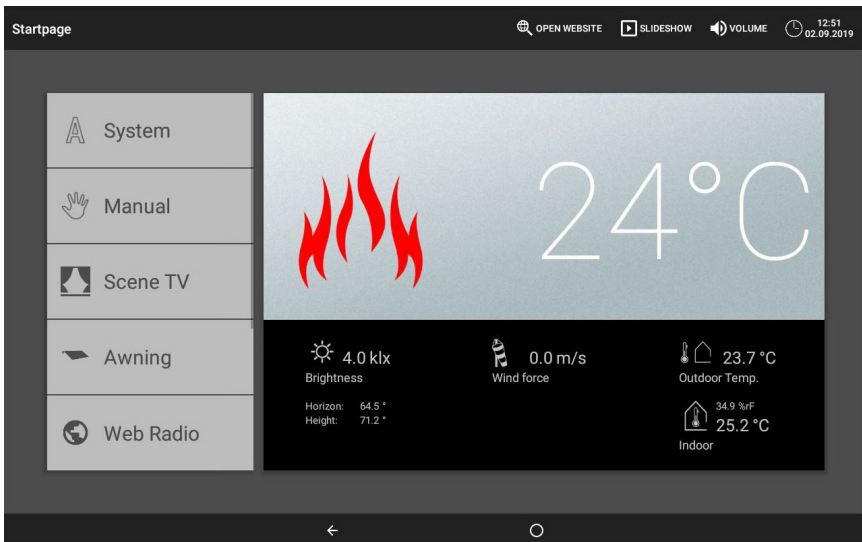

Weather station errors

If a weather station is not connected or if the weather station is defective, the wind, rain and frost alarm are activated as a precaution.

For motors and devices without a wind, rain or frost alarm, manual operation in the menu **Manual** remains possible. Motors that react to wind, rain or frost alarms move to the safe position.

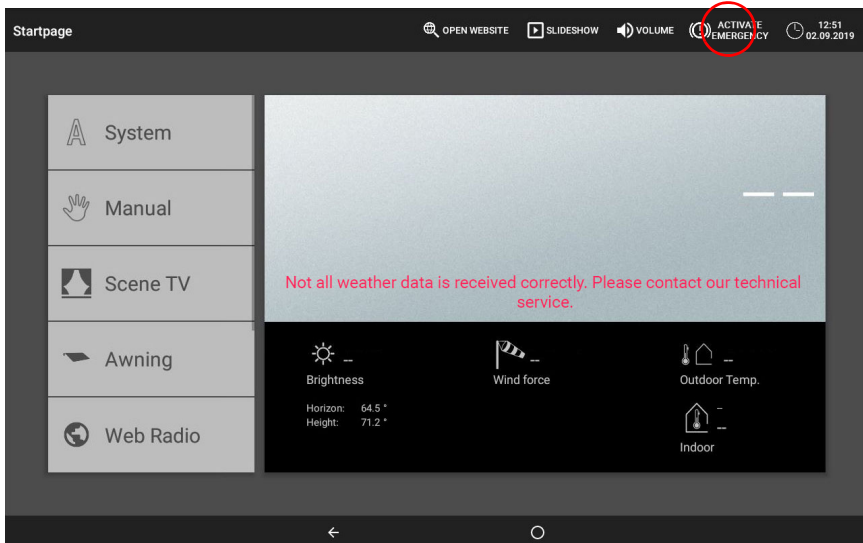

However, so that motors can still be operated manually, activate the emergency mode via the key in the top right of the display. You can deactivate the emergency mode again with the same key.



ATTENTION!

Damage from wind, rain or frost.

In emergency mode, all safety functions are disabled.

- Only use emergency mode briefly in order to position drives manually and then switch it off again.
- Emergency mode also remains active if weather data is received again. Switch it off again manually!

6.5. Wiring diagrams

Motor and MF outputs WS1000 Connect (60241-60244):

max. 400 W per motor output,
total max. 1.5 kW for all motor outputs

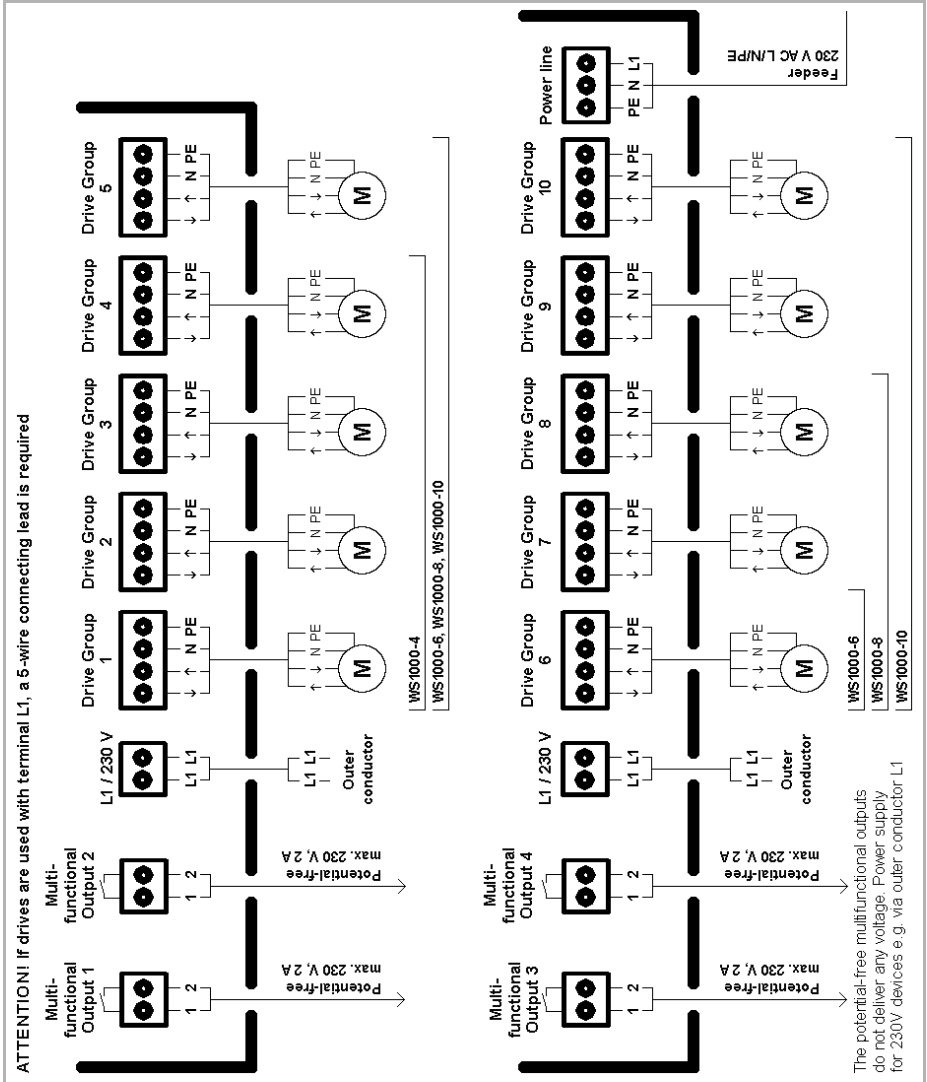

Motor and MF outputs WS1000 Connect-PF (60246):

per motor output max. 5 A / 230 V

Motors with different voltages may be operated at the drive outputs (230 V AC and low voltages SELV). The low voltage drives still correspond to the SELV specifications.

230 V and SELV must not be mixed at adjacent multifunction outputs (1 and 2 or 3 and 4). A mixed connection does not correspond to the SELV specifications. Either 230 V or extra-safety voltages are permitted here.

E.g. it is possible to connection SELV to MF outputs 1 and 2 and 230 V to MF outputs 3 and 4 (or vice versa).

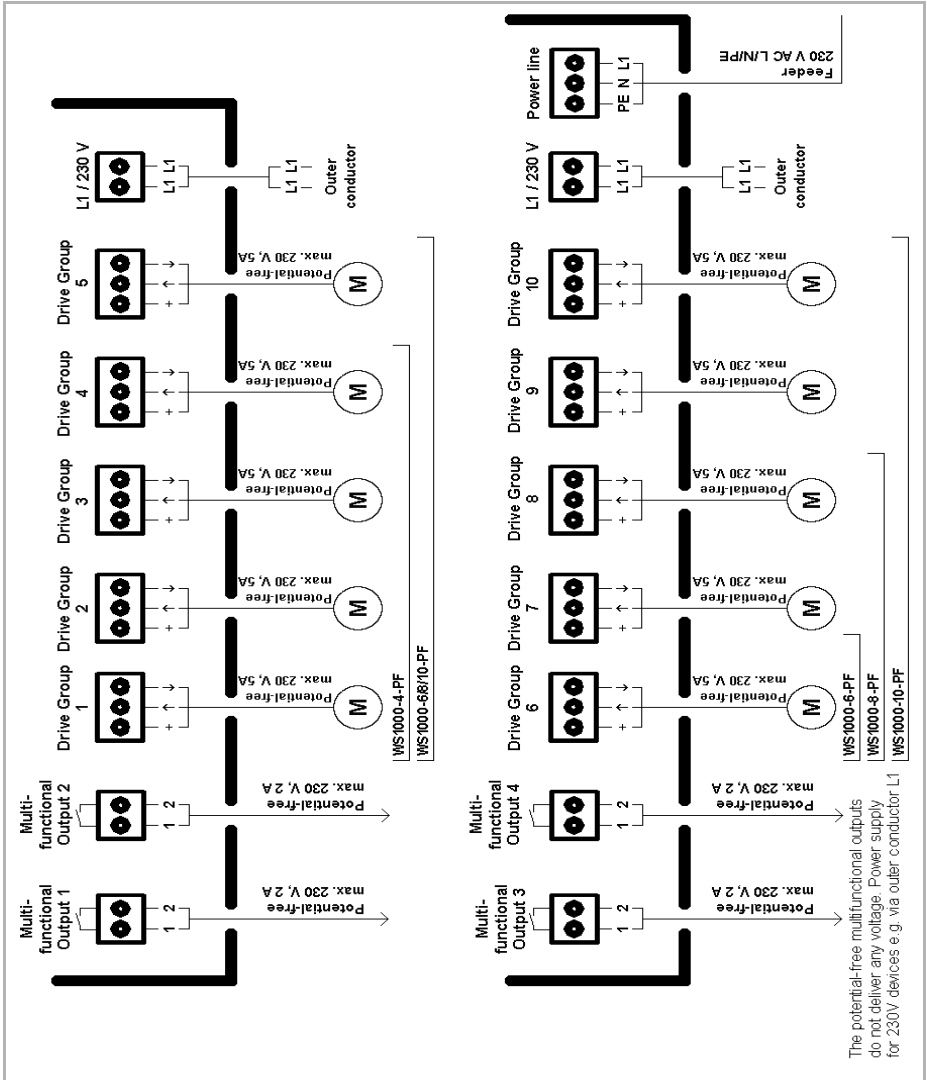

Inputs:

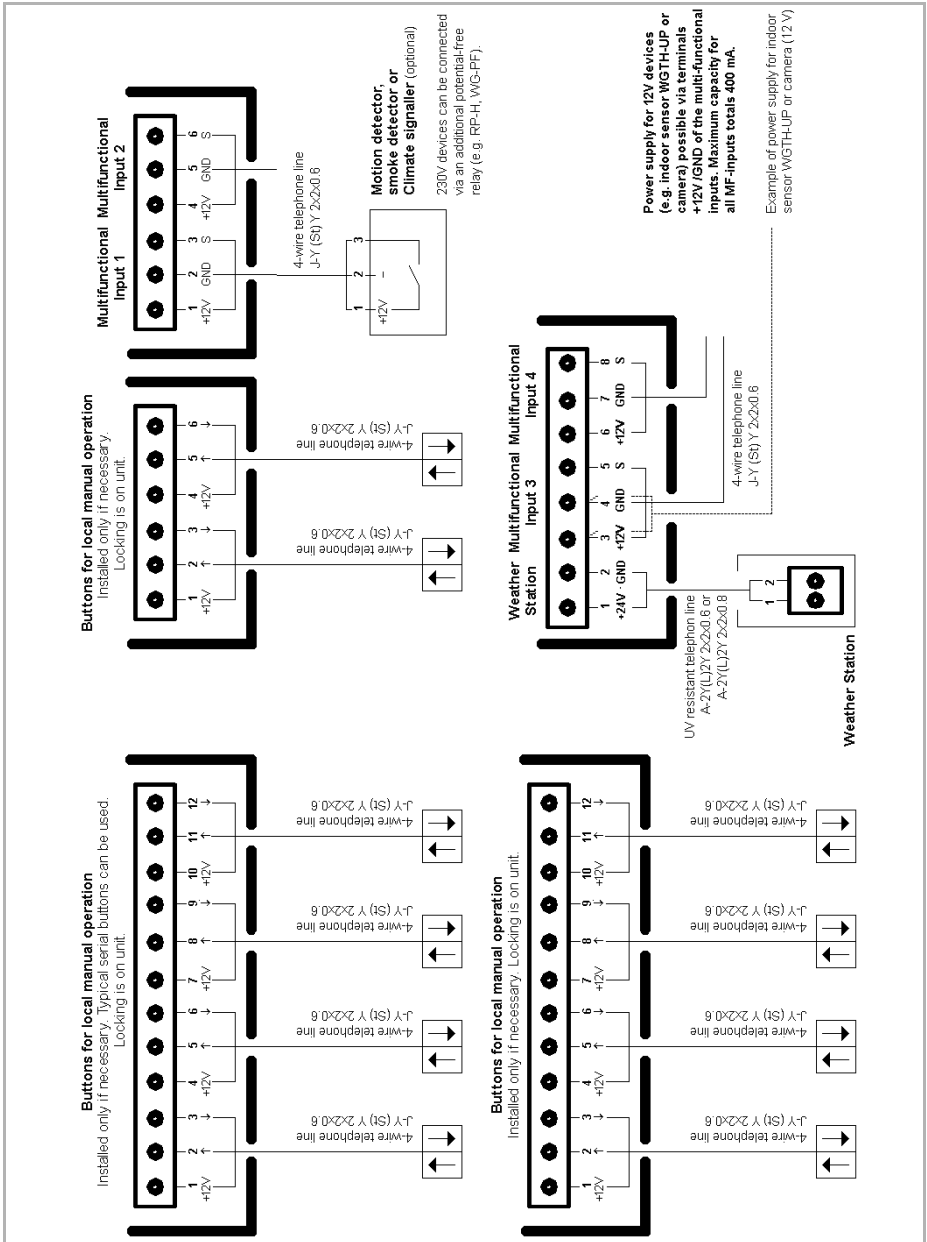

Connection examples for multifunction outputs

230 V consumers at MF outputs:

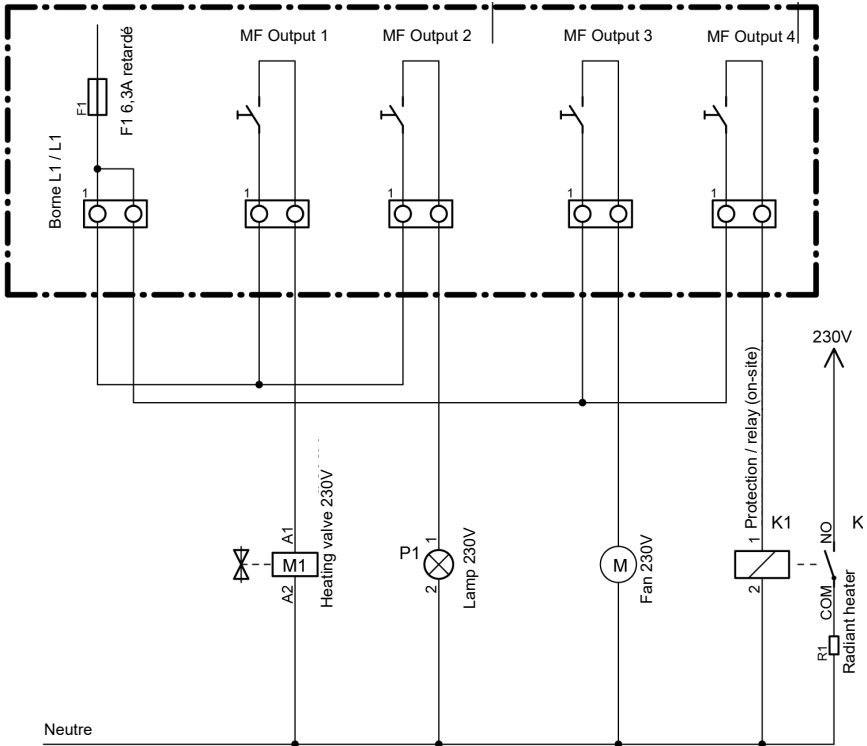

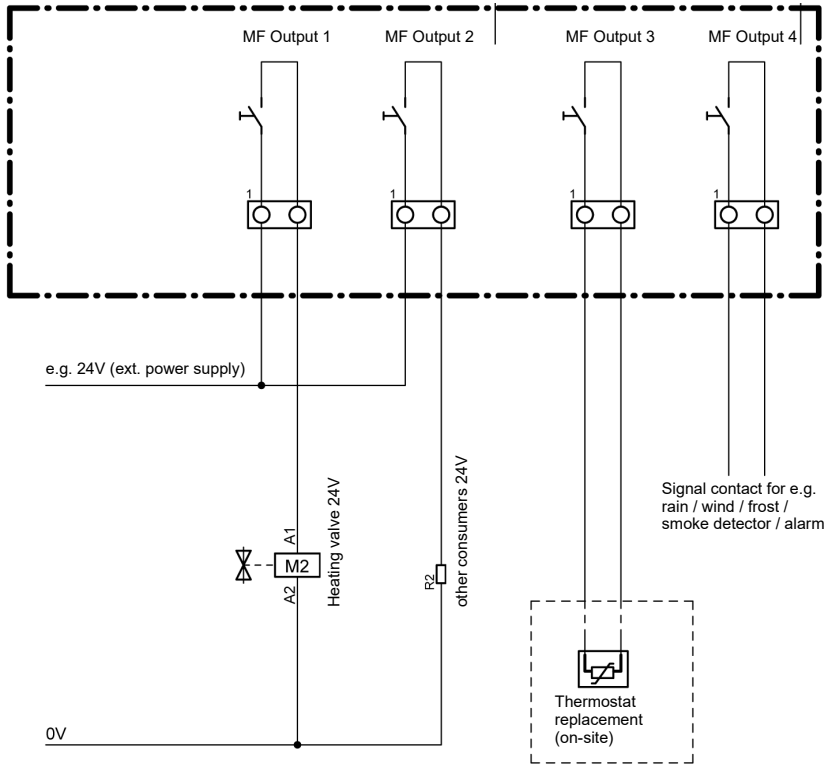
Low-voltage consumers and potential-free contacts at MF outputs:

6.6. Personal automatic settings data

Awnings, blinds, shutters

Drive no. (output)							
Name							
Function							
Light intensity (kLUx)							
Direction of sun							
Height of sun							
Movement position							
Slat position							

Slat position for height of the sun of	0°-15°						
	15°-30°						
	30°-45°						
	45°-90°						
Indoor sensor							
Indoor temperature (°C)							
Night closure?							
Timed closure (period)							
Outdoor temperature (°C)							
Frost alarm?							
Wind alarm at (m/s), Time exceeded							
Rain alarm?							
Automatic reset?							
Reset following manual intervention?							

Extension delay (min)	
Retraction delay (min)	
Twilight value (lux)	

Window

Drive no. (output)							
Name							
Normal, sliding window or step window?							
Indoor sensor							
Indoor temperature (°C)							
Air humidity (%)							
CO2 (ppm)							
Supply air temperature block							
Night-time re-cooling (period, temp., position)							
Movement position/num- ber of steps							
Timed ventilation (period)							

Drive no. (output)						
Name						
Outdoor temperature (°C)						
Timed closure (period)						
Frost alarm?						
Wind alarm at (m/s), Time exceeded						
Rain alarm?						
Gap opening during rain? Position						
Automatic reset?						
Reset following manual intervention?						

Ventilation, heating and cooling units

No. (output)						
Name						
Indoor sensor						
Air humidity (%)						
CO2 (ppm)						
Indoor Temperature (°C)						
Outdoor Temperature (°C)						
Supply air temperature block						
Exhaust air levels						
Night-time re-cooling ven- til. (period, temperature)						
Timed ventil. /Night mode (period, temperature)						
Heat recovery recircula- tion (temperature, step)						
Condensation air recircu- lation (level)						
Automatic reset?						
Reset following manual intervention?						

Ventilation block via air-conditioning (min)	
--	--

Roof gutter heating

No. output						
Name						
Temperature range (°C) from						
Temperature range (°C) to						
Automatic reset?						
Reset following manual intervention?						

Light

No. (output)						
Name						
Twilight operation						
Time switch (period)						
On at alarm?						
Automatic reset?						
Reset following manual intervention?						

General settings

Twilight value (Lux)	
Extension delay shades (min)	
Retraction delay shades (min)	
Ventilation block after cooling (min)	
Night time cooling: Temperature (°C), for longer than (min)	
Frost alarm: outdoor temperature (°C), standby (h)	
Window travel limit (°C)	
Automatic shading wind delay (min)	

Time point for general automatic reset	
Reset following manual intervention (min)	

Timer time periods

	Name	from	to
1			
2			
3			
4			
5			
6			
7			
8			
9			
10			
11			
12			
13			
14			
15			
16			

Questions about the product?

You can reach the technical service of Elsner Elektronik under
Tel. +49 (0) 70 33 / 30 945-250 or
service@elsner-elektronik.de

We need the following information to process your service request:

- Type of appliance (model name or item number)
- Description of the problem
- Serial number or software version
- Source of supply (dealer/installer who bought the device from Elsner Elektronik)

elsner

Elsner Elektronik GmbH Control and Automation Engineering

Sohlengrund 16
75395 Ostelsheim
Germany

Phone +49 (0) 70 33 / 30 945-0 info@elsner-elektronik.de
Fax +49 (0) 70 33 / 30 945-20 www.elsner-elektronik.de
