

- 12/24V control unit
- Display program
- Total programmable

START S10

Manuals

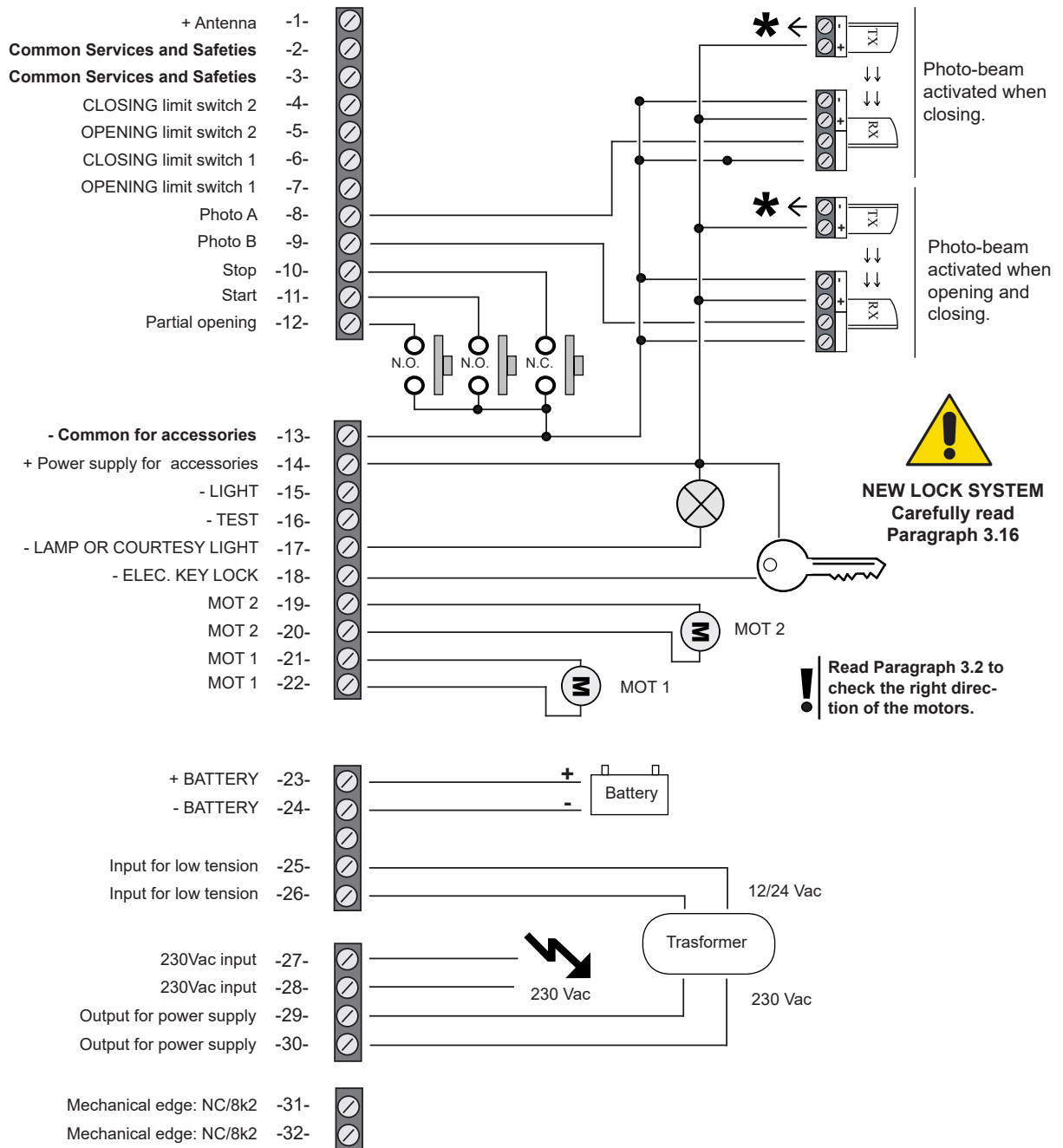

www.nologo.info

www.ebtechnology.it

START-S10_170915_VXX13_GB firmware v1448



* Connect this point to the terminal board no.16 for the photo-test. Otherwise connect it to the terminal board no.13

Foreword

This manual provides all the specific information you need to familiarize yourself with and correctly operate your unit. Read it very carefully when you purchase the instrument and consult it whenever you have doubts regarding use and before performing any maintenance operations.

Safety precautions

Using the unit improperly and performing repairs or modifications personally will void the warranty.

Nologo declines any responsibility for damages due to inappropriate use of the product and due to any use other than the use the product was designed for.

Nologo declines any responsibility for consequential damages except civil liability for the products.

The automation is conformed to the european laws: **EN 60204-1, EN 12445, EN 12453**

It is compulsory to be conformed to the automatic gates: **EN 12453, EN 12445, EN 12978** and national laws.

The force of the door should be measured and adjusted according the maximum values of the norm **EN 12453**.

Environmental protection measures

Information regarding the environment for customers within the European Union. European Directive EC 2002/96 requires that units bearing this symbol on the unit and/or on the packaging be disposed of separately from undifferentiated urban wastes.



The symbol indicates that the product must not be disposed of with the normal household wastes. The owner is responsible for disposing of this product and other electrical and electronic equipment through specific waste collection facilities indicated by the government or local public agencies. Correct disposal and recycling help prevent any potentially negative impact on the environment and human health. To receive more detailed information regarding disposal of your unit, we recommend that you contact the competent public agencies, the waste collection service or the shop where you purchased the product.

Small dictionary

OLS	Opening Limit Switch
CLS	Closing Limit Switch
START	START control
PEDESTRIAN	Partial Opening
Vac	(alternate current)
Vdc	(direct current)
NC	Normally closed
NA o NO	Normally open
Contatto pulito	Isolated contact

Index chapter

1	Introduction	3
1.1	Description of the produc	
1.2	Technical characteristics	
2	Premises	
2.1	Preliminary checks	
2.2	Type of cable	4
2.3	Installation	
2.4	Notes of connections	
2.5	Scheme of the control unit and electrical connections	5
3	Installation of the control unit	6
3.1	Connection of the POWER SUPPLY	
3.2	Connections of the MOTORS	
3.3	Connection of the ANTENNA	
3.4	Power supply of the ACCESSORIES	
3.5	Connection of the STOP	
3.6	Connection of the COURTESY LIGHT	7
3.7	Connection of the SIGNAL LIGHT	
3.8	Set up of the PRE-LIGHTING	
3.9	Connection of the LIGHT	
3.10	Connection of the LIMIT SWITCHES	8
3.11	Connection of the START and PEDONALE	
3.12	Connection of the PHOTO-BEAM A (only closing)	9
3.13	Conneciton of the PHOTOBEAM A with TEST	
3.14	Connection of the PHOTOBEAM B (when opening and closing)	10
3.15	Connection of the PHOTO-BEAM B with TEST	
3.16	Connection of the NEW LOCK SYSTEM	11
3.17	Connection of the MECHANICAL EDGE	
3.18	Connection of the motor with electro-magnetic bloc	
3.19	Check of the connections	
4	Functions and adjustment	12
4.1	Function	
4.2	Activation of the OUTPUTS	13
4.3	Watch the tension of the BATTERIES	
4.4	SPEED and SLOW DOWN of the motors	14
4.5	Level of the OBSTACLE DETECTION	
4.6	Function of the OBSTACLE DETECTION	
5	Installation of the radio receiver and remote controls	15.
5.1	Cancellation of the MEMORY	
5.2	Cancellation of a SINGLE CODE	
5.3	Activation of the ROLLING CODE COUNTER	
5.4	Memorization of the code of the REMOTE CONTROLS	16
6	Learning and programm of the working time with START	
6.1	Working time learning with START	
6.2	Working time learning with START or PARTIAL OPENING	17
7	RESET of the control unit with standard values	
8	Table with all START FUNCTIONS of S10	19
9	CE declaration of conformity	23

1 Introduction

START S10 is a new control unit with time counter and digital slow down. It has been designed for different uses: for one-two motors gates, low tensions motors mechanical and oleodynamic. It has been used the most advanced technologies to guarantee the protection against interferences, the flexibility and the variety of functions.

1.1 Description of the product

☞	Self-learning of the working time
☞	automatic battery charger
☞	Reading and program with DISPLAY
☞	Check of the motors, Max 80W totally
☞	Adjustment of the motor speed and slow down
☞	Obstacle detection for separate motors and separate speed and slow down for the motors
☞	Code managing (up to 197 remote controls)
☞	Test for safety devices before each opening
☞	Opto-isolated inputs, excepted for PARTIAL OPENING

1.2 Technical description

Maximum power with transformer: 100 VA	80 W
Protection Fuse	F1: 3,15 A ritardato - F2: 1,6 A - F3: 8 A
Dimensions	b170 x h90 x p30 mm
Weight	250 g (<i>transformer not included</i>)

2 Premises

Remember that systems for automatic gates and doors must be installed by highly qualified technicians only and in full compliance with current law.

Before starting installation, check that the mechanical consistency and sturdiness of the gate or door, check that the mechanical stops are suitable to stop the movement of the gate or door even if the electrical limit switches should fail or during manual operations.

2.1 Preliminary checks

Making the correct choice of installation is essential to ensuring adequate safety and good protection against atmospheric agents. Remember that the control unit contains powered parts and electronic components which by their very nature are sensitive to infiltrations and moisture. The control unit is supplied in a container which guarantees an IP55 protection rating if adequately installed. Install the control unit on a permanent surface that is perfectly flat, adequately protected against impacts and at least 40 cm off the ground.

The cables must enter the control unit from the bottom only; we recommend using wire leads and water-tight connections. When using tubing that could fill up with water or if the tubing comes from an underground well, the wires must enter a first shunting box placed at the same height as the control unit and then, from there, the wires must be passed into the container holding the control unit, again entering from the bottom.

This prevents any evaporation of the water in the tubing from forming condensation inside the control unit itself.

2.2 Type of electrical wires

Depending on the installation, the type and number of devices installed, the number of cables needed can vary. The table below shows the cables needed for a typical installation. The cables used in the installation must be IEC 60335 compliant.

⇒	Power supply line	Cable 3x1,5 mm ²
⇒	Motor cable (if not equipped)	4x1,5 mm ² Min Cable, for long distances use a 4x2,5 mm ²
⇒	Flashing signal	Cable 2x1 mm ²
⇒	Antenna	Shielded cable type RG58
⇒	Key selector	Cable 3x0,5 o 0,75 mm ²
⇒	Photocell transmitter	Cable 2x0,5 o 0,75 mm ²
⇒	Photocell receiver	Cable 3x0,5 o 0,75 mm ²

2.3 Type of installation

These two simple diagrams show only one of the possible applications for this control unit. The risks inherent to the "MACHINE" and the user's requirements must be analyzed in depth in order to establish how many elements need to be installed. All NOLOGO photocells have a system of synchronism that makes it possible to eliminate interference between two pairs of photocells (for other details, see the instructions for the photocells).

In the diagram, photocells "FOTO A" in opening they have no effect, while it provoke a complete inversion during closing. "FOTO A2" is the serial connection of "FOTO A" or "ALT, FOTO B" is the photocell working by closing and opening.

Installations for swing gates

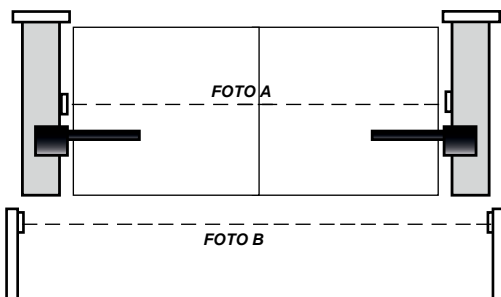

Application on sliding automation

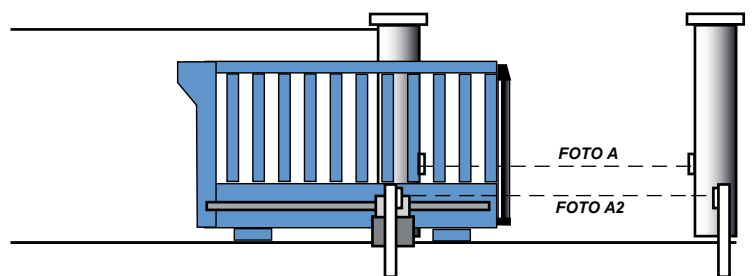

2.4 Notes on connections

To guarantee operator safety and to prevent damaging the components, never make connections or insert wireless receiver boards while the control unit is powered.

- Power the control unit through a 3 x 1.5 mm cable. If the distance between the control unit and the ground system connection is more than 30 m, a ground plate must be installed in proximity to the control unit.
- If the motors do not have a cable, use the 4 x 1.5 mm² cable (open + close + common + ground), for long distances use a 4x2,5 mm².
- In connecting the part with an extremely low safety voltage, use cables with a minimum section of 0,5 o 0,75mm².
- Use shielded cables if the length exceeds 30m and connecting the ground braid only from the side of the control unit.
- Do not connect the cables in underground cases even if they are water-tight.
- If they are not used, the inputs to the Normally Closed (NC) contacts must be jumpered to the common".
- If the same input has more than one contact (NC), they are placed in series.
- If they are not used, the inputs to the Normally Open (NO) contacts are left loose.
- If the same input has more than one contact (NO), they are to be placed in series.
- The contacts must be mechanical and free of any potential.

Remember that systems for automatic gates and doors must be installed by highly qualified technicians only and in full compliance with current law.

2.5 Scheme of the control unit and electrical connections

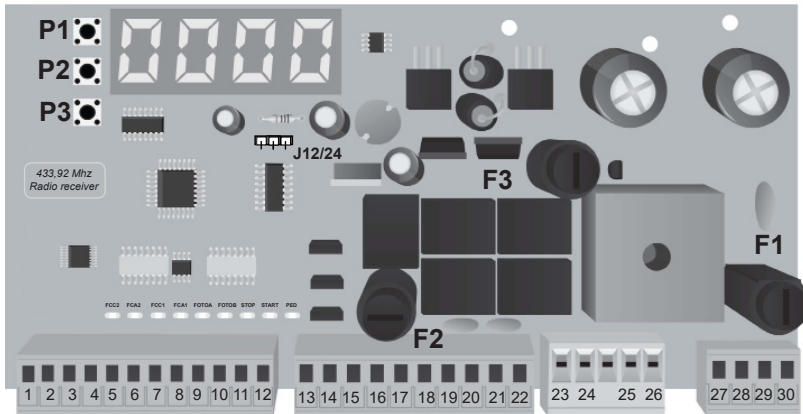

SET UP OF THE CONTROL UNIT

To program the control unit press **P1**, the gate must be closed (*if you press P1 when the control unit is turning on. It leaves the function before the turning off*)

Use **P2** or **P3** to select different groups **T, L, S, C, R**, or select **E** to go back to the standard function. The control unit will reset all functions and go back to the normal status after 60 seconds which is unused.

Press **P1** to confirm the operation, **P2** and **P3** to choose the set up, if you need to go back to the group of set up press **P2+P3**



WHEN THE CONNECTION IS FINISHED

When the connection is finished, check the motors as shown in the Par. 4.2 Function R. Then before the memorization of the working time, set up the speed, obstacle detection and activation/deactivation of the inputs.

1 → 18	Tension for accessories, inputs, services and safeties
19 → 22	Power supply of the motor
23 → 30	Power supply of the control unit, Battery
J12/24	Selection of the 12/24V power supply
P1 P2 P3	Buttons to reset the control unit
F1	Fuse for Transformer power supply - 3,15 A Rit.
F2	Fuse power supply, accessories and logic - 1,6 A
F3	Fuses for power supply of the motors - 8 A

+ Antenna	-1-	
Common Services and Safeties	-2-	
Common Services and Safeties	-3-	
Closing limit switch 2	-4-	
Opening limit switch 2	-5-	
Closing limit switch 1	-6-	
Opening limit switch 1	-7-	
Photo A	-8-	
Photo B	-9-	
Stop	-10-	
Start	-11-	
Partial opening	-12-	

- Common for accessories	-13-	
+ Power supply for accessories	-14-	
- LIGHT	-15-	
- TEST	-16-	
- LAMP OR COURTESY LIGHT	-17-	
- ELEC. KEY LOCK	-18-	
MOT 2	-19-	
MOT 2	-20-	
MOT 1	-21-	
MOT 1	-22-	

Read Paragraph 3.2 to check the right direction of the motors.

- BATTERY	-23-	
+ BATTERY	-24-	
Input for LOW TENSION	-25-	
Input for LOW TENSION	-26-	
230 Vac input	-27-	
230 Vac input	-28-	
Output for power supply	-29-	
Output for power supply	-30-	

Mechanical edge: NC/8k2	-31-	
Mechanical edge: NC/8k2	-32-	

3 Installation of the control unit

3.1 Connection of the TENSION

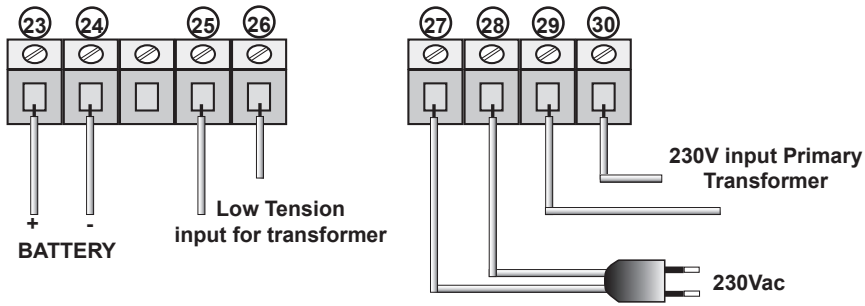

The control unit can be powered **12 Vac/24 Vac**

12 Vac:

Put the **J12/24** as in the picture
Set to "0" the set up **S 21**.

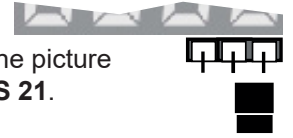

24 Vac:

Put the in **J12/24** as shown
Set "1" the set up **S 21**.

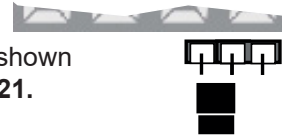

The power supply line has to be protected from a magneto-thermic switch or from a couple of 5A fuses.
A differential switch is useful if it is already available in the installation.

3.2 Connections of the MOTORS

Pay attention not invert the poles OPEN and CLOSE.

When the connection is finished, in case of doubts put manually the gate in the middle and read **Paragraph 4.2** to check the right direction of the motors.

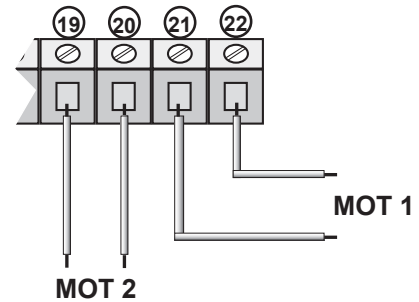

3.3 ANTENNA connections

In case of using a cable (as antenna) for the frequency 433.92mhz, you can cut at 17cm and connect it to the terminal board 1.

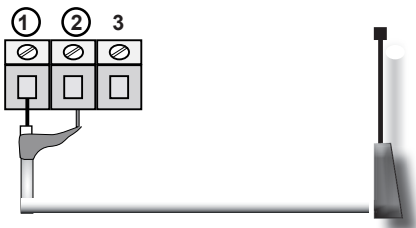

3.4 Power supply of the accessories

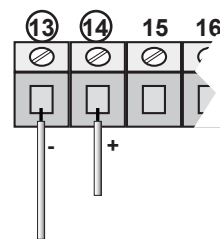

Connect the terminal board **13** and **14** to power the accessories.

The tension on top of the terminal boards is up of the transformer.

3.5 Connection of the STOP device

Connection of the **STOP** control

Button: stop the control unit until a new contro.

Switch: it stops the automation until a new control.

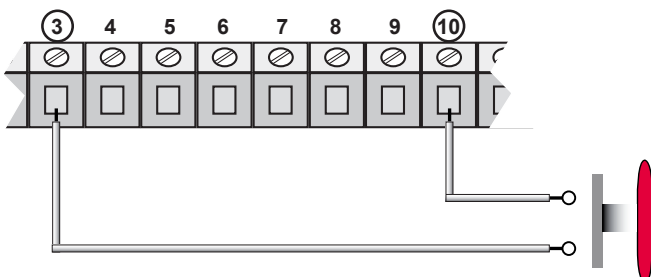

! If the input **STOP** is not used, put "0" in the set up **S15**

Connection of the safety devices requires the use of any push-button or N.C. (normally closed) contact.
When there are several safety devices, they are connected in series.

3.6 Connection of the COURTESY LIGHT

To activate the courtesy light function, as shown in the picture **S03**

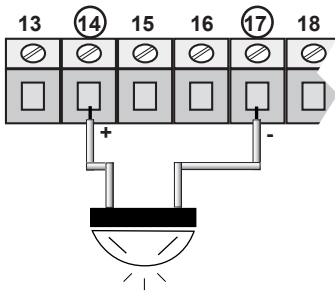

Set up	Val	Description	
S 03	1	Courtesy light in the LAMP output	In the terminal board 17 and 14 tension is available up to 255s after. <i>Standard value 0s</i>
T 18		Working time Courtesy light	Can be set up from 0 to 255 s <i>Standard value 120s</i>

3.7 Connection of the LAMP

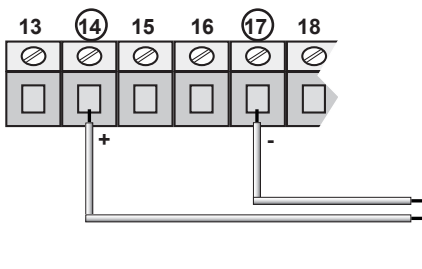

Put the set up **S25** at **1**, if you use a lamp without flashing light, otherwise put the **S25** at **0**.

Set up	Value	Description
S 25	1	Activate the Lighting
	0	Deactivate the lighting <i>Standard</i>

To activate the function "lamp during pause time" put **S 05** at **1**, to deactivate the function put **S05** at **0**.

Set up	Val	Description	
S 05	1	Lamp in pause time	<i>The light is working in the pause time, too. (Standard value 0)</i>

3.8 PRE-LIGHTING

To increase or reduce pre-lighting time, put **T 15** and **T 16** as follow:

Set up	Description	
T 15	Pre-lighting time when CLOSED	Set up from 0 a 10 s <i>Standard Value 2 s</i>
T 16	Pre-lighting time when the gate is OPEN	Set up from 0 a 10 s <i>Standard value 2 s</i>

3.9 Connection of a 24 light when the gate is open and when it is moving

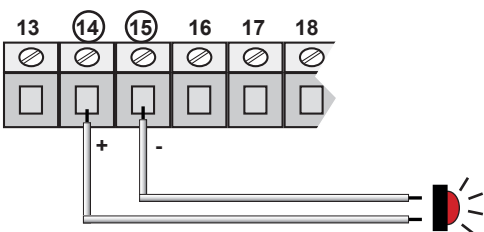

Set up	Value	Description	
S 07	1	Fix light	The Fix light indicates the gate opens.
	0	Flashing light	The output light is flashing <i>(standard version)</i>

3.10 Connection of the LIMIT SWITCHES

In the picture is shown the connection of both limit switches but in this control unit you can use separately. So you can use only OPENING limit switches or only CLOSING limit switches.

To deactivate the input LIMIT SWITCHES do as shown in the table

Set up	Value	Description		Set up	Value	Description	
S 11	0	Deactivation of the input opening limit switch 1	Standard value 1	S 13	0	Deactivation of the input opening limit switch 2	Standard value 1
S 12	0	Deactivation of the input closing limit switch 1	Standard value 1	S 14	0	Deactivation of the input closing limit switch 2	Standard value 1

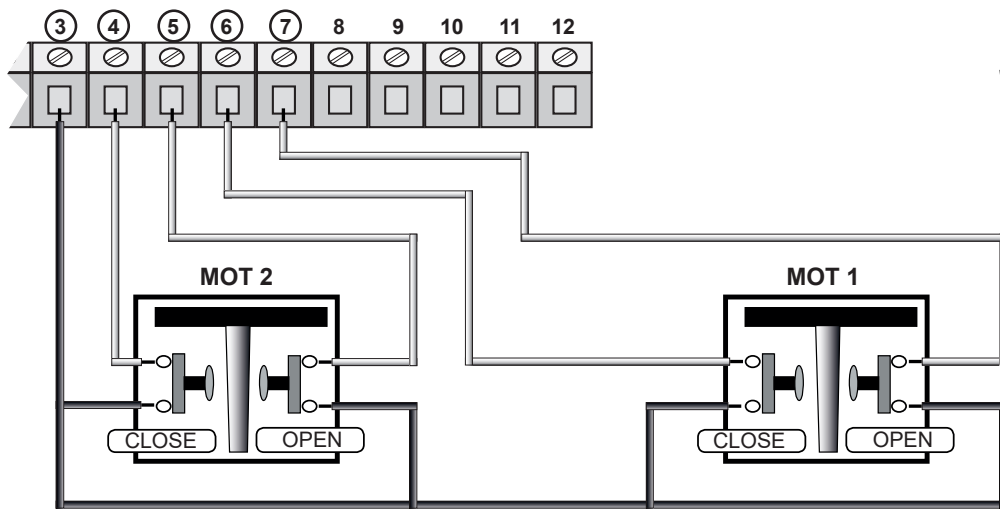

! The limit switches contact should be normally closed.

3.11 Connection of an OPENING CONTROL / START / PARTIAL OPENING

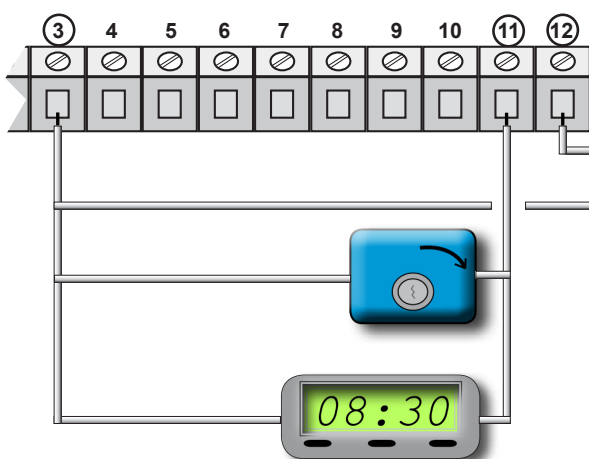

The connection of a PARTIAL OPENING can be done with every button or a normally open contact.

The connection of a START can be done with every button or a normally open contact. If more devices are available, they should be serial connected.

If you use the terminal boards no.3 and no.11 it is possible to connect a TIMER to program the opening time of the gates. The contact should be normally open and it is closed for all the time the gate is open. If the connection with the opening gates is available in the terminal board no.16, connect it in parallel.

3.12 Connection of the PHOTO A (only closing)

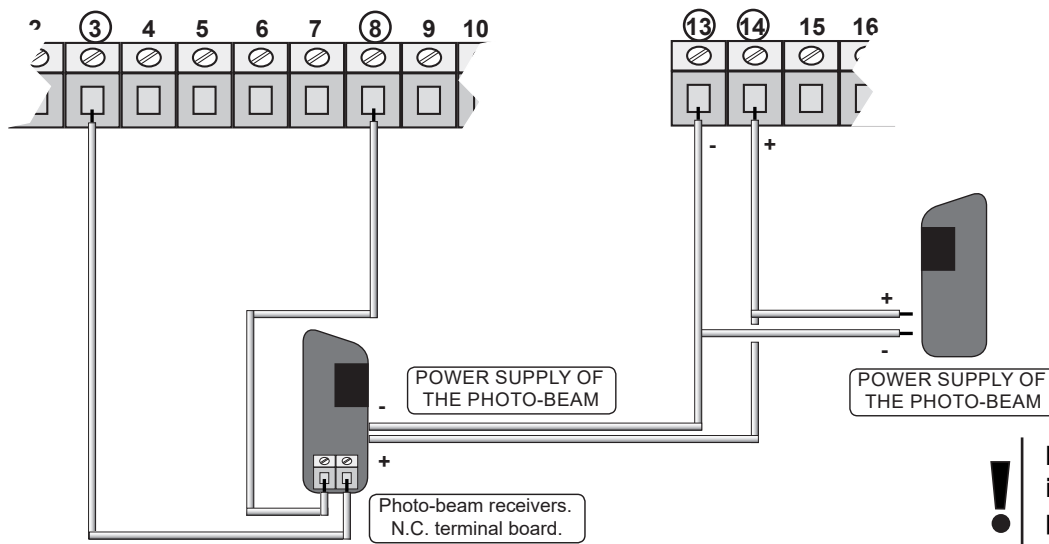

The normally closed contact of the receiver should be isolated from tension.

If you use more couples of photo-beams the connection should be serial.

! If the input FOTO is not used, put the S16 at "0"

3.13 Connection of the PHOTO-BEAM FOTO A (only closing) with PHOTO-TEST

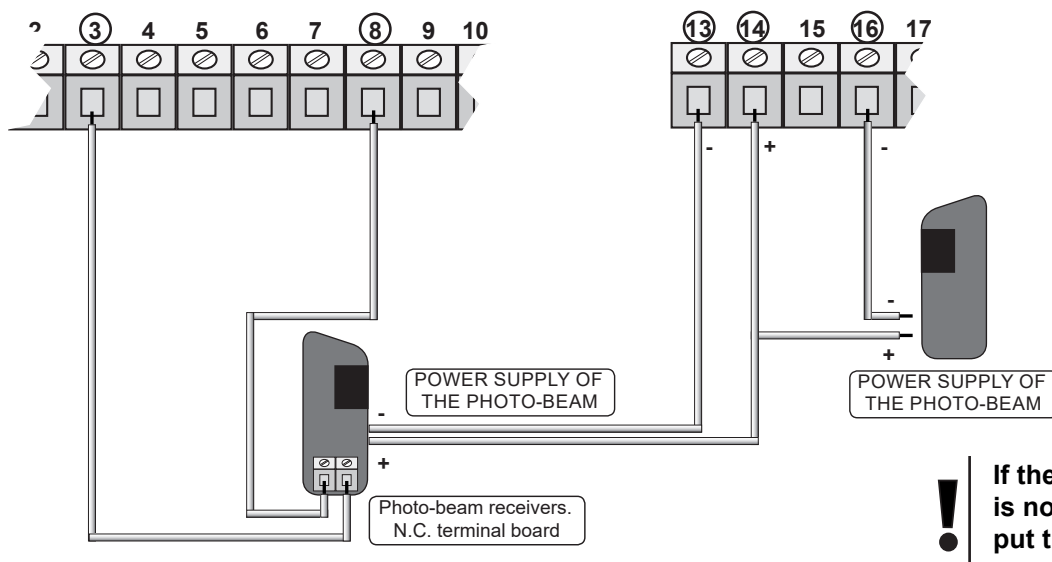

The normally closed contact of the receiver should be isolated from tensions.

If you use more couples of photo-beams the connection should be serial.

! If the input FOTO is not used, put the S16 at "0"

The PHOTO-TEST checks the right working of the gate if the photo-beams are working properly. The control unit will do a test before the gate opening.

In case the photo-beams are not working properly, the lamp will be turned on and the gate is not working.

To activate the TEST put at 1 the PHOTO A:

Set up	Value	Description
S 06	1	Activate the TEST output for INPUT TEST (Val. Default 0)
S 22	1	To activate the TEST put at 1 the PHOTO A (Val. Default 0)

If you don't need the PHOTO-TEST, connect the photo-beams (see Par. 3.2) and put at 0 in the function S22 and S06 (S06 should be deactivated only when other TEST are not available)

3.14 Connection of the PHOTO-B (in opening and closing)

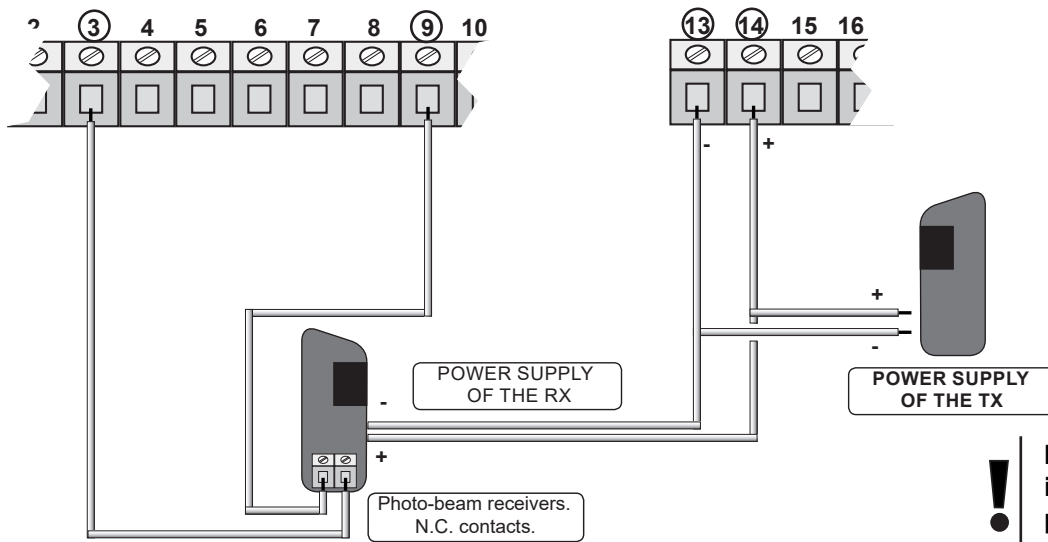

The normally closed contact of the receiver should be isolated from tensions.

If you have more couples of photo-beams the connection should be serial.

! If the input PHOTO-STOP is not used, put the S17 at "0"

3.15 Connection of the PHOTO-BEAM B (opening and closing) with TEST

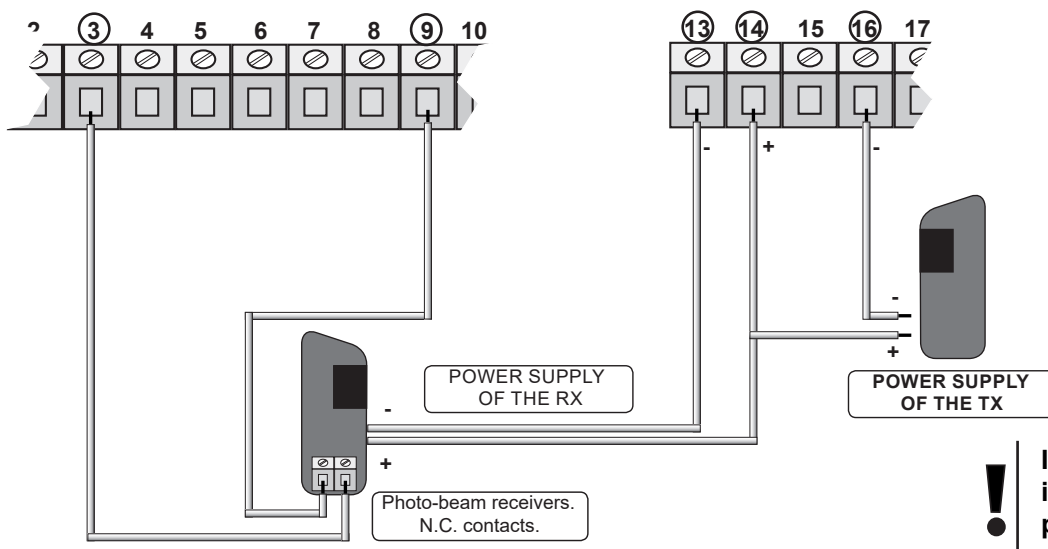

The normally closed contact of the receiver should be isolated from tensions.

If you have more couples of photo-beams the connection should be serial.

! If the input PHOTO-STOP is not used, put the S16 at "0"

The PHOTO-TEST check that the gate is working only if the photo-beams are working properly.

The control unit will do a general test before opening.

In case the photo-beams are not working properly, the signal light will turn on for 5 seconds and the gate is not working

To activate the PHOTO-TEST put at "1" the set up of the photo-beams PHOTO-B:

Set up	Value	Description
S 06	1	Activate the TEST output for INPUT TEST (Standard Value 0)
S 23	1	Activate the input TEST for PHOTO-B (Standard Value 0)

If you want to go back to the function without PHOTO-TEST, connect the photo-beams as shown in the Paragraph 3.14 and put the function S23 and S06 at "0" (deactivate the S06 only when other inputs have no TEST)

4 Function and adjustment



Check the right function of the motors and the accessories as shown in the par. 4.2 and then, if you don't know the working time of the motors, program the speed (see Par. 4.4), obstacle detection (see Par. 4.5) and activation/deactivation of the inputs.

4.1 Function

Set up		Function	Description
S 01	1	Fast reverse <i>(Standard value)</i>	By each control it reverse: open-close
	2	Collective use	When opening and pause time it doesn't accept any control, it re-close automatically.
	3	Step-by-step function	Each control it follows each: open-stop-close-stop-open No automatic reclosing
	4	Step-by-step with automatic re-closing after pause time	By each control it follows open-stop-close-stop-open.. It recloses automatically after the pause time.
	5	Industrial use	The PARTIAL OPENING control has a closing function, too while START follow the logic of dip1 and dip 2
	6	Man present function	The START control opens, the PARTIAL OPENING closed. The motors stop after the button will be released.
S 02	1	Reclosing when turning off <i>(Default 0)</i>	Make a complete opening and closing cycle, only in case the tension has been broken, when the gate was open.
S 04	1	Passage control <i>(Default 0)</i>	When the photo-beams realize the passage, if S19 has value 0, the pause time is 2sec.
S 19	1	Riverse at the passage check <i>(Default 1)</i>	Put S04 at 1 . When the function is activated and the gate is opening, the control unit reverse the direction of the motors and close.
S 07	1	Fixed Light <i>(Default 0)</i>	The light is lit on when the gate is open.
S 09	1	Activation of soft-start <i>(Default 0)</i>	The motors have minimum values until the settled values.
S 10	1	ONE MOTOR function <i>(Default 0)</i>	If you put at 1 the S10, the control unit can synchronise the move of the motors. The working time memorization will be done only for motor no.1

4.2 Activation OF THE OUTPUTS



The control unit can activate separately the electric-lock output, lamp, Photo-test, Light, Motors, Slow down:

1	R ...	Press P2 and P3 until you reach R...
2	 P1	Keep pressed the button P1 to activate the output
3	 P1	Release button P1 to deactivate the output

R 02	Key lock		R 06	Mot 1 - OP		R 10	Mot 2 - OP
R 03	Lamp		R 07	Mot 1 - CL		R 11	Mot 2 - CL
R 04	Test		R 08	Mot 1 - OP - SLOW DOWN		R 12	Mot 2 - OP - SLOW DOWN
R 05	Light		R 09	Mot 1 - CL - SLOW DOWN		R 13	Mot 2 - CL - SLOW DOWN

4.3 Check the BATTERY TENSION

The control unit can check , with the display, the tension of the battery or if the battery is charged:

1	R 14	Press the P2 and P3 in the function R14
2	 P1	Keep pressed the button P1 to check the tension
3	 P1	Release button P1 to stop the check

4.4 SPEED and SLOW DOWN OF THE MOTOR

This operation can adjust just the speed of the motor when opening and closing and the slow down.

! Make this operation before the memorization of the working time.

Set up	Description	Values	Standard Value
L 01	Standard speed MOT1	from 1 to 10	10
L 02	Speed of slow down MOT1	from 1 to 10	5
L 03	Standard speed MOT2	from 1 to 10	10
L 04	Speed of slow down MOT2	from 1 to 10	5

4.5 Level of the MOTOR

This operation can adjust the obstacle detection.

Look on the table.

! 1 = Very sensitive
5 = Medium sensitive
10 = Low sensitive

! If the functions **L05** and **L06** are on "0", the control unit will be damaged if the motors will stop for just one second.

Set up	Description	Values	Standard Value
L 05	Level of obstacle detection or LS MOT1	from 1 to 10 (0 = deactivation)	5
L 06	Level of obstacle detection o LS MOT2	from 1 to 10 (0 = deactivation)	5
L 07	Level of obstacle detection o LS MOT1 in case of slow downfrom	from 1 to 10 (0 = deactivation)	5
L 08	Level of obstacle detection o LS MOT2 in case of slow downfrom	from 1 to 10 (0 = deactivation)	5

4.6 Logic of OBSTACLE DETECTION

If you use **S20** you can set up the obstacle detection:

Set up	Description	Values	
S 20	Logic of obstacle detection	1	LIMIT SWITCH FUNCTION (standard function)
		2	STOP function
		3	STOP function but before it reverse the move of the motors for 2 seconds

! **WARNING**
Use the set up 2 and 3 only in case the limit switch is available.

5 Managing of the remote control

This receiver can manage standard codes from 12 till 64 bit and rolling codes HCS®. The first learned transmitter establish the code's type that the receiver has to manage, it means that the transmitter has to have the same code's type. The code can be from 12 to 64 bit and for rolling code HCS, the receiver will manage only the fix part of the code and not the rolling code counter. The first learned transmitter establish the code's type that the receiver has to manage, it means that the transmitter has to have the same code's type.

5.1 CANCELLATION of the MEMORY CODE

This operation cancel all previous memorized codes. To cancel one single code see next paragraph. **IT IS NECESSARY TO RESET THE MEMORY BEFORE THE MEMORIZATION OF THE FIRST REMOTE CONTROL.** The cancellation of one single code is possible when the gate is CLOSED.

To cancel the memory code, choose **C03** with button **P2** and **P3**. Then confirm the operation with **P1**. **Wait 10 seconds as indicated in the DISPLAY**, if the button **P1** will be pressed in these **10 seconds**, the operation will be cancelled.

Set up	Description
C 03	Reset of the memory code.

5.2 CANCELLATION of a SINGLE CODE

This operation cancell one single code in the memory.

Choose **C04** with **P2** and **P3**. The confirm with **P1**.

Press the button of the remote control. **Wait in the display "CANC"**

Set up	Description
C 04	Cancellation of a code

5.3 Activation of the ROLLING CODE HCS



If you choose **1** with **S08**, the control unit will accept HCS rolling code and the control unit will check the rolling code counter. The rolling code remote controls cannot be copied. If this operation is not activated, the receiver will accept only the fix part of the code.

Set up	Description	Values confirmed
S 08	Funzione HCS Completo	0 deactivated (<i>Standard value</i>) 1 activated

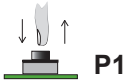

5.4 Memorization of the remote controls

This function can memorize one or more remote controls. It is sufficient that the receiver is compatible with the most branded remote controls in the market, once you memorized the first remote control, the next codes should be of the same type. If it is a 12V remote control (for example dip-switch) it will be memorized only 12 bits remote control.

START REMOTE Control

1	C 01	Press P2 and P3 on C01
2	 P1	Confirm the operation with P1
3		When the remote control has been memorized, see SUCC on the DISPLAY.



PARTIAL OPENING

1	C 02	Press P2 and P3 on C02
2	 P1	Confirm the operation with P1
3		Press the button of the remote control. When the remote control has been memorized, see SUCC on the DISPLAY

6 MEMORIZATION and PROGRAM of the WORKING TIME

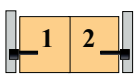
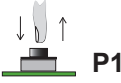
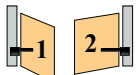

This function can fastly and easily ad just the working time to open and they can be changed as shown in the next paragraph.

6.1 WORKING time memorization

1		The gate has to be closed
2	R 01	Press P2 and P3 until you see R01
3	 P1	Confirm with P1 .
4		The gate will open and close separately from the motors.
5a		If the limit switches or the obstacle detection are available, the control unit will do a complete cycle.
5b	 P1	If the limit switches are not available, press P1 .
7		If the safety will not work, repeat the operation again.

6.2 WORKING TIME MEMORIZATION with START control

To change the program of the control unit make as follow:



1	T ...	Press P2 and P3 until you will find T...
2	 P1	Press P1 to choose the set up
3	 P2 P3	Press P2 and P3 to choose the value
4	 P1	Press P1 to confirm the operation

Set up	Description	Values confirmed	Default
T 01	Opening time MOT1	from 2 to 127,5 s	15 s
T 02	Closing time MOT 1	from 2 to 127,5 s	15 s
T 03	Opening time MOT2	from 2 to 127,5 s	15 s
T 04	Closing time MOT2	from 2 to 127,5 s	15 s
T 05	Slow down when opening MOT 1	<i>(in advance)</i> from 2 to 127,5 s	2 s
T 06	Alow down when opening MOT 2	<i>(in advance)</i> from 2 to 127,5 s	2 s
T 07	Slow down when closing MOT1	<i>(in advance)</i> from 2 to 127,5 s	3 s
T 08	Slow down when closing MOT2	<i>(in advance)</i> from 2 to 127,5 s	3 s
T 09	Opening Displacement	from 2 to 127,5 s	2 s
T 10	Closing Displacement	from 2 to 127,5 s	2 s
T 11	Pause time for START	from 2 to 127,5 s	10 s
T 12	Opening time MOT1 PARTIAL OPENING time	from 2 to 127,5 s	8 s
T 13	Closing time MOT1 PARTIAL OPENING time	from 2 to 127,5 s	8 s
T 14	Pause time for PARTIAL OPENING	from 2 to 127,5 s	10 s

T 17	KEY LOCK function	from 0 to 10 s	2 s
T 19	Reversing stroke	<i>(0 for deactivation)</i> from 0 to 10 s	0 s
T 20	Starting of MOT1 <i>(when starting, the obsctacle detection is not available)</i>	from 0 to 10 s	2 s
T 21	Starting of MOT2 <i>(when starting, the obsctacle detection is not available)</i>	from 2 to 10 s	2 s

7 Reset of the control unit at STANDARD VALUE

The control unit can bring back the standard value (see par. 8) to reset make as follow:

1	S 18	Press P2 and P3 until S18
2	 P1	Press P1 to confirm the operation
3	 P1	To cancel the operation press P1 for 10 seconds



WARNING!
This operation
cancel all
benchmarks

8 TABLE INDICATING the FUNCTION of START S10

8.1 Set up of group “T”

SET UP	DESCRIPTION	VALUE	STANDARD VALUE	NOTE
T 01	Opening time MOT 1	from 2 to 127,5 s	15 s	
T 02	Closing time MOT 1	from 2 to 127,5 s	15 s	
T 03	Opening time MOT 2	from 2 to 127,5 s	15 s	
T 04	Closing time MOT 2	from 2 to 127,5 s	15 s	
T 05	Opening slow down MOT 1 (<i>in advanced</i>)	from 2 to 127,5 s	2 s	
T 06	Closing slow down MOT 2 (<i>in advanced</i>)	from 2 to 127,5 s	2 s	
T 07	Opening slow down MOT1 (<i>in advanced</i>)	from 2 to 127,5 s	3 s	
T 08	Closing slow down (<i>in advanced</i>)	from 2 to 127,5 s	3 s	
T 09	Opening Displacement time	from 2 to 127,5 s	2 s	
T 10	Closing displacement time	from 2 to 127,5 s	2 s	
T 11	Pause time for START control	from 2 to 127,5 s	10 s	
T 12	Opening time MOT 1 with PARTIAL OPENING	from 2 to 127,5 s	8 s	
T 13	Closing time MOT1 with PARTIAL OPENING	from 2 to 127,5 s	8 s	
T 14	PAUSE TIME for PARTIAL OPENING control	from 2 to 127,5 s	10 s	
T 15	PRE-LIGHTING time when opening	from 0 to 10 s	2 s	
T 16	PRE-LIGHTING time when open	from 0 to 10 s	2 s	
T 17	KEY LOCK	from 0 to 10 s	2 s	
T 18	COURTESY LAMP	from 2 to 127,5 s	120 s	
T 19	Reversing Stroke (0 for deactivation)	from 0 to 10 s	0 s	
T 20	STARTING time MOT 1	from 0 to 10 s	2 s	
T 21	STARTING time MOT 2	from 0 to 10 s	2 s	

8.2 Set up of group “L”

SET UP	DESCRIPTION	VALUE	STANDARD VALUE	NOTE
L 01	Standard speed of MOT1	from 0 to 10	10	
L 02	Reduced speed of MOT1	from 0 to 10	5	
L 03	Standard speed of MOT2	from 0 to 10	10	
L 04	Reduced speed of MOT2	from 0 to 10	5	
L 05	Obstacle detection or Limit Switch of MOT1	(0 deactivation) from 0 to 10	5	
L 06	Obstacle detection or Limit Switch of MOT2	(0 deactivation) from 0 to 10	5	
L 07	Obstacle detection or Limit Switch of MOT1 when slowing down	(0 deactivation) from 0 to 10	5	
L 08	Obstacle detection or Limit Switch of MOT2 when slowing down	(0 deactivation) from 0 to 10	5	

8.3 Set up of group "S"

SET UP	DESCRIPTION	VALUE	STANDARD VALUE	NOTE
S 01	Logic of the control unit: 1 - Fast reverse 2 - Collective use 3 - Single stable function 4 - Single stable with automatic re-closing after pause time 5 - Industrial use 6 - "Man Present" function	from 1 to 6	1	
S 02	Activation of AFTER BREAKING of the power supply	0 Off - 1 On	0	
S 03	Activation of COURTESY LIGHT on LAMP	0 Off - 1 On	0	
S 04	Activation of PASSAGES	0 Off - 1 On	0	
S 05	Activation of LAMP in PAUSE TIME	0 Off - 1 On	0	
S 06	Activation of TEST OUTPUT for test of the inputs (<i>in off INTERLOCK</i>)	0 Off - 1 On	0	
S 07	Activation of FIXED LIGHT	0 Off - 1 On	0	
S 08	Activation of ROLLING CODE HCS function	0 Off - 1 On	0	
S 09	Activation of SOFT START	0 Off - 1 On	0	
S 10	Activation of SINGLE MOTOR FUNCTION	0 Off - 1 On	0	
S 11	Activation of Input in Opening Limit Switch 1	0 Off - 1 On	1	
S 12	Activation of input Closing Limit Switch 1	0 Off - 1 On	1	
S 13	Activation of Input in Opening Limit Switch 2	0 Off - 1 On	1	
S 14	Activation of input Closing Limit Switch 2	0 Off - 1 On	1	
S 15	Activation of input STOP	0 Off - 1 On	1	
S 16	Activation of input PHOTO	0 Off - 1 On	1	
S 17	Activation of input PHOTO-STOP	0 Off - 1 On	1	
S 18	RESET of the set up values and brign back to the standard value			
S 19	ctivation of the REVERSE in case of PASSAGE bearing (S 04 = 1)	0 Off - 1 On	1	
S 20	Logic of the Obstacle Detection: 1 - Function as limit switch 2 - Function as STOP 3 - Function as REVERSE and then STOP	from 1 to 3	1	
S 21	Select tension 0=12; 1=24V	0 12V - 1 24V	0	
S 22	Check TEST in the input CLOSING PHOTO-BEAMS	0 Off - 1 On	0	
S 23	Check on Photo-Test when CLOSING/OPENING	0 Off - 1 On	0	
S 24	Check on TEST in the input STOP	0 Off - 1 On	0	
S 25	Activate the Lighting	0 Off - 1 On	0	
S 26	Activate Electro-magnetic bloc	0 Off - 1 On	0	

8.3 Set up of group “C”

SET UP N°	DESCRIPTION
C 01	Memorization of the TX for START control
C 02	Memorization of the TX for START control
C 03	RESET of the MEMORY
C 04	CANCELLATION of a SINGLE CODE

8.4 Set up of group “R”

SET UP N°	DESCRIPTION
R 01	MEMORIZATION of the WORKING TIME of the motors
R 02	Activate the KEY LOCK until you press P1
R 03	Activate SIGNAL LIGHT until you release P1
R 04	Activate TEST until you release P1
R 05	Activate LIGHT until you release P1
R 06	Activate OPEN MOT1 until you release P1
R 07	Activate OPEN MOT1 until you release P1
R 08	Activate OPEN MOT1 when slowing down until you release P1
R 09	Activate CLOSE MOT1 when slowing down until you release P1
R 10	Activate OPEN MOT2 until you release P1
R 11	Activate CLOSE MOT2 until you release P1
R 12	Activate OPEN MOT 2 until you release P1
R 13	Activate CLOSE MOT2 until you release P1
R 14	Check the tension of the battery until you release P1

NOTE:

NOTE:

9 Declaration of CE conformity

(according to EC Directive 2006/42, Attachment II, part 1, ses. A)

The undersigned **Ernestino Bandera**,
Administrator

DECLARES THAT:



Company: EB TECHNOLOGY SRL
Address: Corso Sempione 172/5
 21052 Busto Arsizio VA Italy
Product's name: START-S10
 12/24V control unit

THE PRODUCT COMPLIES	with what is outlined in the European Community directive:
-----------------------------	---

2006/42/CE	EC DIRECTIVE 2006/42 ISSUED BY THE EUROPEAN PARLIAMENT AND COUNCIL on June 22, 1998 harmonizing the legislation of the member countries regarding machinery.
-------------------	--

Reference: Attachment II, part 1, ses. A (EC Declaration of Conformity issued by the manufacturer).

IL PRODOTTO E' CONFORME	with what is outlined in the following European Community directives, as modified by EEC Directive 93/68 issued by the EUROPEAN COUNCIL on July 22, 1993
--------------------------------	---

2006/95/CE	EEC DIRECTIVE 2006/95 ISSUED BY THE EUROPEAN COUNCIL on December 22, 2006 harmonizing the legislation of the member countries regarding electric materials for use within certain voltage limits
-------------------	--

Reference to harmonized standards: EN 60335-1

2004/108/CE	EEC DIRECTIVE 89/336 ISSUED BY THE EUROPEAN COUNCIL on December 15, 2004, harmonizing the legislation of the member countries regarding electromagnetic compatibility.
--------------------	--

Reference to harmonized standards: EN 61000-6-2 EN 61000-6-3

IL PRODOTTO E' CONFORME	with the essential requirements of article 3 of the following European Community Directive, for the use for which the product is designede
--------------------------------	---

1999/5/CE	EC DIRECTIVE 1999/5 ISSUED BY THE EUROPEAN PARLIAMENT AND COUNCIL on March 9, 1999 regarding wireless units and telecommunications terminals and their reciprocal recognition
------------------	---

Reference to harmonized standards: ETSI EN 300 220-3 ETSI EN 301 489-1 ETSI EN 301 489-3

The directive 2006/42/CE remind that it is not allowed the function of the product until the machine, for which the product is included, is not indentify and declared conformed to the 2006/42/CE directive.

Dairago, li 1 ottobre 2010
 The Administrator
 Ernestino Bandera

EB TECHNOLOGY S.r.l.
 Corso Sempione 172/5,
 21052 Busto Arsizio VA Italy
 tel. +39 0331.683310
 fax. +39 0331.684423

NOLOGO S.r.l.
 via Cesare Cantù 26,
 20020 Villa Cortese MI Italy
 tel. +39 0331.430457
 fax. +39 0331.432496

Ernestino Bandera

posta@ebtechnology.it
 www.ebtechnology.it

info@nologo.info
 www.nologo.info



<p>DICHIARAZIONE DI CONFORMITA'</p> <p>Il sottoscritto, rappresentante il seguente costruttore, dichiara che l'apparecchio denominato</p> <p>START-S10</p> <p>risulta conforme a tutte le norme tecniche relative al prodotto entro il campo di applicabilità delle Direttive Comunitarie 2006/95/CE, 99/5/CE e 2004/108/CE</p> <p>Sono state eseguite tutte le necessarie prove di radiofrequenza</p> <p>EB TECHNOLOGY SRL Corso Sempione 172/5 21052 Busto Arsizio (Va) Italia</p> <p>Questa dichiarazione viene emessa sotto la sola responsabilità del costruttore e, se applicabile, del suo rappresentante autorizzato.</p> <p>Busto Arsizio (Va) - Italia, 01/10/2010</p> <p>ERNESTINO BANDERA Amministratore</p>	<p>DECLARATION OF CONFORMITY</p> <p>The undersigned, representative of the following manufacturer, hereby certifies that the equipment known as</p> <p>START-S10</p> <p>complies with all technical requirements concerning this product within the domain of application of the EC Directives 2006/95/CE, 99/5/CE and 2004/108/CE</p> <p>All necessary radiofrequency tests have been performed</p> <p>EB TECHNOLOGY SRL Corso Sempione 172/5 21052 Busto Arsizio (Va) Italia</p> <p>This declaration is rendered under the manufacturer's sole responsibility, and if applicable, under responsibility of his authorized representative.</p> <p>Busto Arsizio (Va) - Italia, 01/10/2010</p> <p>ERNESTINO BANDERA Administrator</p>	<p>DÉCLARATION DE CONFORMITÉ</p> <p>Le soussigné, représentant du constructeur suivant certifie que les appareils ci-dessus référencés</p> <p>START-S10</p> <p>sont conformes à toutes les normes techniques relativement au produit dans le domaine d'application des Directives Européennes 2006/95/CE, 99/5/CE et 2004/108/CE</p> <p>Toutes les essais de radiofréquence nécessaires ont été effectués</p> <p>EB TECHNOLOGY SRL Corso Sempione 172/5 21052 Busto Arsizio (Va) Italia</p> <p>Cette déclaration est présentée sous la seule responsabilité du constructeur et, si applicable, de son représentant autorisé.</p> <p>Busto Arsizio (Va) - Italia, 01/10/2010</p> <p>ERNESTINO BANDERA Administrateur</p>
<p>KONFORMITÄTSZERTIFIKAT</p> <p>Der Unterzeichner bescheinigt, dass das Produkt</p> <p>START-S10</p> <p>allen technischen Produktegesetzen, laut den Europäische Gesetzen 2006/95/CE, 99/5/CE e 2004/108/CE, entspricht.</p> <p>Alle Radiofrequenzprüfungen haben bei der nachstehenden Firma stattgefunden:</p> <p>EB TECHNOLOGY SRL Corso Sempione 172/5 21052 Busto Arsizio (Va) Italia</p> <p>Diese Bescheinigung wird unter der alleinigen Verantwortung des Herstellers ausgestellt und dort woanwenbar, auch unter der des beigefügten Vertreters.</p> <p>Busto Arsizio (Va) - Italia, 01/10/2010</p> <p>ERNESTINO BANDERA Verwalter</p>	<p>DECLARACIÓN DE CONFORMIDAD</p> <p>El abajo firmante, representante el fabricante siguiente, declara que el equipo denominado</p> <p>START-S10</p> <p>es conforme con todas las normas técnicas correspondientes al producto en el campo de aplicación de las Directivas Comunitarias 2006/95/CE, 99/5/CE y 2004/108/CE</p> <p>Han sido realizadas todas las necesarias pruebas de radiofrecuencia.</p> <p>EB TECHNOLOGY SRL Corso Sempione 172/5 21052 Busto Arsizio (Va) Italia</p> <p>Esta declaración se expide bajo la exclusiva responsabilidad del fabricante y, si de aplicación, de su representante autorizado.</p> <p>Busto Arsizio (Va) - Italia, 01/10/2010</p> <p>ERNESTINO BANDERA Administrador</p>	<p>DECLARAÇÃO DE CONFORMIDADE</p> <p>O abaixo-assinado, representando o seguinte construtor declara que o aparelho denominado</p> <p>START-S10</p> <p>é conforme a todas as normas técnicas relativas ao produto dentro o campo de aplicabilidade das Diretivas Comunitarias 2006/95/CE, 89/336/CEE e 99/5/CE</p> <p>Foram executadas todas as necessárias provas de rádio frequência.</p> <p>EB TECHNOLOGY SRL Corso Sempione 172/5 21052 Busto Arsizio (Va) Italia</p> <p>Esta declaração vem emitida somente com a responsabilidade do construtor e, se aplicável, do seu representante autorizado.</p> <p>Busto Arsizio (Va) - Italia, 01/10/2010</p> <p>ERNESTINO BANDERA Administrador</p>