

### FEATURES

- 320 mA KNX power supply with 29 VDC auxiliary output
- 110-240 VAC 50/60 Hz power input
- Power generation for the KNX system (with LED indicator)
- Short-circuit and overvoltage protection
- Reset button and overload status LED
- KNXnet/IP tunnelling protocol (up to 5 connections)
- Maximum APDU length of 254 bytes
- Ethernet 10/100 BaseT IP with RJ45 socket
- 2 different configurable blocks: shutter channels (up to 4), individual outputs (up to 8) and 2/4-pipe fan coil controls (up to 1)
- Outputs suitable for capacitive loads, maximum 140 µF
- Manual output operation through remote control
- 8 analog/digital inputs
- Climate control for up to 4 rooms
- Output timing
- 20 logic functions
- Clock with NTP support
- Total data saving on KNX bus failure
- Integrated KNX BCU (TP1-256)
- Dimensions 71 x 90 x 140 mm (8 DIN units)
- DIN rail mounting according to IEC 60715 TH35, with fixing clamp
- Possibility of connecting different phases in adjacent channels
- Conformity with the CE, UKCA, RCM directives (marks on the right side)

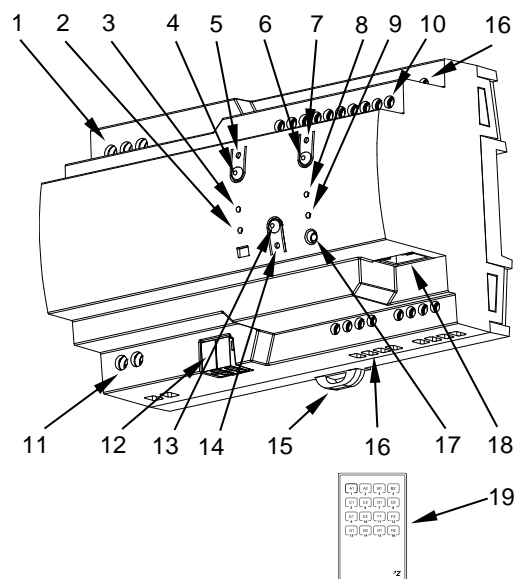

Figure 1: ALLinBOX 88

1. Main power supply	2. Overload status LED	3. Power supply status LED	4. Reset button	5. Reset status LED
6. IP factory reset button	7. IP factory reset LED	8. Ethernet LED	9. KNX bus LED	10. Analog/digital inputs
11. Auxiliary power output	12. KNX connector	13. Programming/Test button	14. Programming/Test LED	15. Fixing clamp
16. Outputs	17. IR input	18. Ethernet connector	19. Remote control (not included, ref. 9900024)	

**PROGRAMMING/TEST BUTTON:** short press to set programming mode. If this button is held while providing main power supply to the device, it enters the safe mode. If this button is held for more than 3 seconds, the device enters the test mode.

**PROGRAMMING/TEST LED:** programming mode indicator (red). When the device enters the safe mode, it blinks (red) every half second. The test mode is indicated by the green color. During the start-up (reset or after providing main power supply) and if the device is not in safe mode, it starts a blue blinking sequence.

**POWER SUPPLY STATUS LED:** it indicates the status of the power supply (green color: the device is working properly; off LED: power supply failure; green blinking: short-circuit on KNX bus and/or auxiliary power output).

**OVERLOAD STATUS LED:** it indicates an overload on the KNX line or on the auxiliary power output (red blinking: cut-off due to overload/short circuit on the KNX bus and/or the auxiliary power output\*; red color: overload on bus and/or auxiliary power output line\*).

\*Reduce the load on the bus and/or the auxiliary power output lines until its total consumption does not exceed the maximum current specified.

**KNX BUS LED:** it indicates that the device is powering up the KNX bus (green color).

**ETHERNET LED:** it indicates that the device is connected to Ethernet and has an IP address assigned (green color).

**RESET INDICATOR LED:** it indicates that a reset of the KNX system has been performed by using the corresponding reset button (red blinking). To reset the bus power supply, the Reset button should be pressed (it is recommended to hold it for at least 5 seconds to verify the reset of all the devices in the line). The reset LED will blink slightly in red while the Reset button is pressed.

**IP FACTORY RESET INDICATOR LED:** it indicates that the device has just performed an IP factory reset (red color). To reset the KNX IP Interface, the IP Factory reset button must be pressed for at least 3 seconds.

**MANUAL CONTROL:** In order to perform manual control of the device, an IR remote control (not included; ref. 9900024) is necessary. When the device is in Test On mode, the manual control can be done by pressing the corresponding buttons on the IR remote control (please, be sure that the remote IR emitter is pointing to the IR input of ALLinBOX 88).

GENERAL SPECIFICATIONS		
CONCEPT	DESCRIPTION	
Type of device	Electric operation control device	
External power supply	Voltage	110-240 VAC 50/60 Hz PF=0.5
	Maximum consumption	250 mA @ 110 VAC / 125 mA @ 230 VAC
KNX supply	Voltage (typical)	29 VDC SELV (with KNX coil)
	Maximum rated current (I <sub>BUS</sub> )	320 mA
	Connection type	Typical TP1 bus connector for 0.8 mm Ø rigid cable
Additional output	Voltage (typical)	29 VDC SELV
	Maximum rated current (I <sub>AD</sub> )	I <sub>AD</sub> + I <sub>BUS</sub> ≤ 320 mA
Operation temperature	-5 .. +45 °C	
Storage temperature	-20 .. +55 °C	
Operation humidity	5 .. 95%	
Storage humidity	5 .. 95%	
Complementary characteristics	Class B	
Protection class / Overvoltage category	I / III (4000 V)	
Operation type	Continuous operation	
Device action type	Type 1	
Electrical stress period	Long	
Degree of protection / Pollution degree	IP20 / 2 (clean environment)	
Installation	Independent device to be mounted inside electrical panels with DIN rail (IEC 60715)	
Minimum clearances	Not required	
Power failure back-up time	110 ms	
Maximum current before overload notification	500 mA	
Response on KNX bus failure	Data saving according to parameterization	
Response on KNX bus restart	Data recovery according to parameterization	
Operation indicator	See page 1	
Weight	521 g	
PCB CTI index	175 V	
Housing material / Ball pressure test temperature	PC FR V0 halogen free / 75 °C (housing) - 125 °C (connectors)	

MAIN POWER SUPPLY SPECIFICATIONS AND CONNECTIONS		
CONCEPT	DESCRIPTION	
Power supply protection fuse	Voltage	110-240 VAC 50/60 Hz
	Current	6.3 A
	Response type	F (Fast acting)
Connection method	Screw terminal block (0.5 Nm max.)	
Cable cross-section	1.5-4 mm <sup>2</sup> (IEC) / 26-10 AWG (UL)	

AUXILIARY POWER OUTPUT SPECIFICATIONS AND CONNECTIONS	
CONCEPT	DESCRIPTION
Connection method	Screw terminal block (0.5 Nm max.)
Cable cross-section	1.5-4 mm <sup>2</sup> (IEC) / 26-10 AWG (UL)

OUTPUTS SPECIFICATIONS AND CONNECTIONS		
CONCEPT	DESCRIPTION	
Number of outputs	8	
Output type / Disconnection type	Potential-free outputs through bistable relays with tungsten pre-contact / Micro-disconnection	
Rated current per output	AC 16(6) A @ 250 VAC (4000 VA) DC 7 A @ 30 VDC (210 W)	
Maximum load per output	Resistive	4000 W
	Inductive	1500 VA
Maximum inrush current	800 A/200 µs 165 A/20 ms	
Different phases connection	Possibility of connecting different phases. It is not allowed to connect power supplies of different order, SELV with NO SELV, in the same block.	
Maximum current per block	40 A	
Maximum current per channel	16 A	
Short-circuit protection	NO	
Overload protection	NO	
Over-voltage protection	NO	
Connection method	Screw terminal block (0.4 Nm max.)	
Cable cross-section	0.5-2.5 mm <sup>2</sup> (IEC) / 26-12 AWG (UL)	
Outputs per common	2	
Maximum response time	10 ms	
Mechanical lifetime (min. cycles)	3 000 000	
Electrical lifetime (min. cycles) <sup>1</sup>	100000 @ 8 A / 25000 @ 16 A (VAC)	

<sup>1</sup> Lifetime values could change depending on the load type.

## WIRING DIAGRAMS

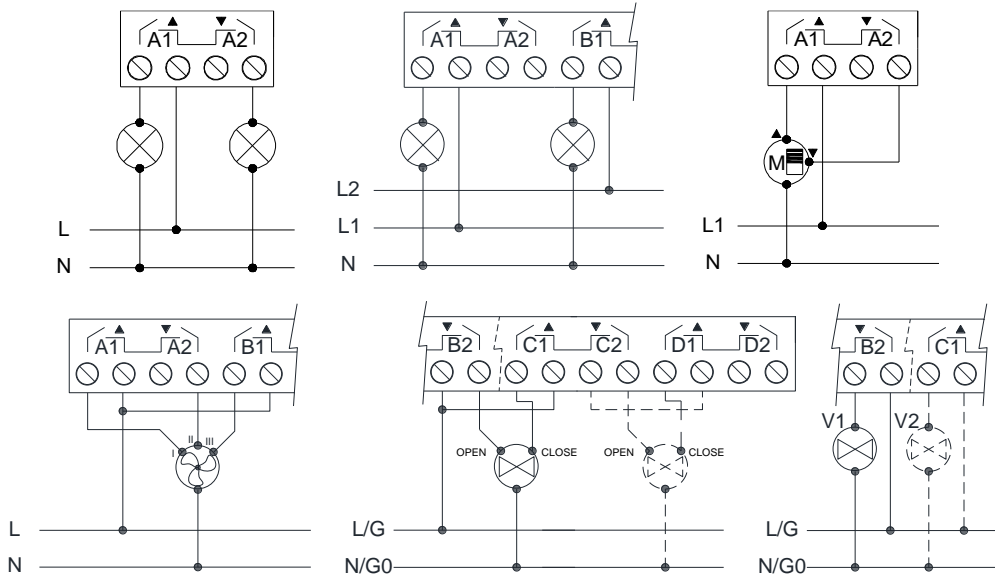

⚠ In order to ensure the expected status of the relays, please check that the device is connected to the main power supply before energizing the power circuit.

For a 4-pipe fan coil, the cooling valve should always be connected on the left side and the heating valve on the right side. Before the start-up of the device, it must be assured that the valve is completely closed.

The fan and the valves to be connected must have the same nominal supply voltage.

Outputs that are not being used for valve control can be used as individual outputs or shutter channels.

Figure 2: Wiring example (from left to right and from top to bottom): 2 loads, 2 loads connected to different phases, shutter channel, fan coil three-speed fan, fan coil three-point valves and fan coil open/close valves.

## INPUTS SPECIFICATIONS AND CONNECTIONS

CONCEPT	DESCRIPTION
Number of inputs	8
Inputs per common	4
Operation voltage	+3.3 VDC in the common
Operation current	1 mA @ 3.3 VDC (per input)
Switching type	Dry voltage contacts between input and common
Connection method	Screw terminal block (0.4 Nm max.)
Cable cross-section	0.5-2.5 mm <sup>2</sup> (IEC) / 26-12 AWG (UL)
Maximum cable length	30 m
NTC accuracy (@ 25 °C) <sup>2</sup>	±0.5 °C
Temperature resolution	0.1 °C
Maximum response time	10 ms

<sup>2</sup> For Zennio temperature probes.

## INPUTS CONNECTION

Any combination of the following accessories is allowed in the inputs:

### Temperature Probe\*\*

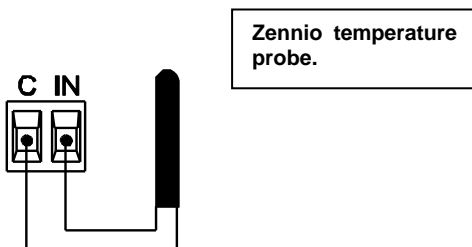

### Motion Sensor

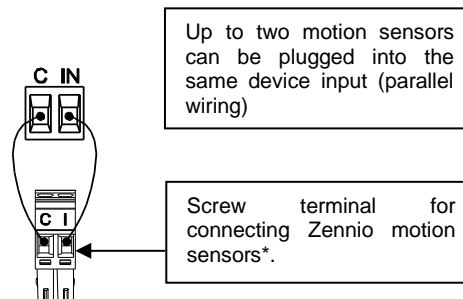

### Switch/Sensor/ Push button

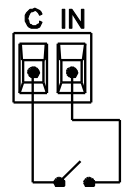

\* In case of using ZN110-DETEC-P sensor, its micro switch number 2 must be in **Type B position**.

\*\* Zennio temperature probe or any NTC with known resistance values at three points in the range [-55, 150 °C].

⚠ Commons of different devices must not be connected together.

## INSTALLATION AND CONNECTION

- This device must be exclusively installed in a 35 mm DIN rail inside a distribution box or an electrical panel.
- Ensure suitable ventilation to prevent the temperature from exceeding the permissible range.
- Main power must be connected to L, N and ground terminals.
- ALLinBOX must be supplied by its own power supply, it is not allowed to supply it through the bus using a different power supply due to its high consumption.
- The coil integrated bus output must be connected through a standard KNX connector.
- The additional output connection must be connected according to the polarity indicated on the housing.

Attaching ALLinBOX 88 to DIN rail:

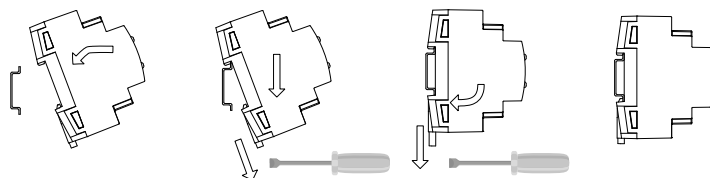

Removing ALLinBOX 88 from DIN rail:

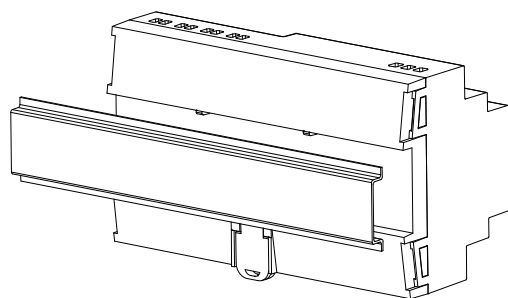
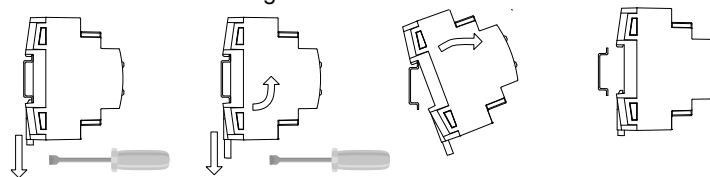

Figure 3: Mounting ALLinBOX 88 on DIN rail



### SAFETY INSTRUCTIONS AND ADDITIONAL NOTES

- Installation should only be performed by qualified professionals according to the laws and regulations applicable in each country.
- Do not connect the mains voltage nor any other external voltage to any point of the KNX bus; it would represent a risk for the entire KNX system. The facility must have enough insulation between the mains (or auxiliary) voltage and the KNX bus or the wires of other accessories, in case of being installed.
- The facility must be equipped with a device that ensures the omnipolar sectioning. Installation of a 10 A mini-circuit-breaker is recommended. To prevent accidents, it must remain open in case of manipulation of the device.
- The device has a short-circuit protection fuse that, in case of activation, should only be rearmed or replaced by the Zennio technical service.
- This device contains a security short-circuit proof transformer.
- Once the device is installed (in the panel or box), it must not be accessible from outside.
- For indoor use only.
- Keep the device away from water (condensation over the device included) and do not cover it with clothes, paper or any other material while in use.
- The WEEE logo means that this device contains electronic parts and it must be properly disposed of by following the instructions at <https://www.zennio.com/en/legal/weee-regulation>.
- This device contains software subject to specific licences. For details, please refer to <https://zennio.com/licenses>.

