

TECHNICAL MANUAL



NEBUCLEAN200, NEBUCLEAN300, NEBUCLEAN400, NEBUCLEAN500

Sanitizing fog systems



The warranty of **NEBUCLEAN** is two years and is handled directly from the dealer or authorized installer, so please contact your supplier to take advantage of warranty with the copy of the purchase document that contains the serial number of the machine. Not included in the warranty: moving parts and/or damages depending on the incorrect use unless it is found a manufacturing defect in origin. Liquid and bags are not covered by warranty.



BY BREAKING THE SECURITY LABELS AND THE OPENING OF THE MACHINE YOU WILL ACCEPT WHAT IS WRITTEN ON THIS MANUAL.

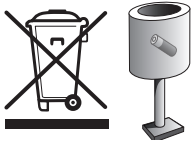

We recommend to throw away the batteries in the appropriate waste containers for recycling. Heavy metals contained in them are recyclable.

Serial number.....
Date of installation.....
Signature of installer



At the end of the installation, write down the identification number of the machines, the date of the installation and sign in the dedicated spaces.

Thank you for purchasing a NEBUCLEAN product

The great technological innovations such as the fluid injection system, the disposable bag, the ecological and economic system for the complete emptying of the bag, together with the heating system, make the Nebuclean fogging systems the best performing devices in the security market.

- **Simple:** Machine easy to install and able to be integrated to any existing alarm system; they lodge 1 fog fluid bag.
- **Cheap:** The lowest power consumption among fogging systems.

The fog generated by **NEBUCLEAN** does not create problems or injuries to people during a short stay in a room filled with fog, if the system is used according to the manufacturer's recommendations. The generated fog is certified as safe for people and animals from an authorized international certification company and it is proven that it does not leave any residual. **NEBUCLEAN** products are certified respecting European laws and regulations. Any certifications required in specific countries are a responsibility of the distributor of that specific country. It is not guaranteed by the manufacturer the use of **NEBUCLEAN** system in the presence of objects that may be damaged anyway by the contact with substances based on glycol, water and alcohol. Any employee or worker that may be exposed to fog must be warned in advance and must be checked for any allergy to the substances listed above. At the date of printing of this manual it has never been pointed out any problem related to any allergy. **The company** is in no way responsible for any damage or condition of use that has not been required and specifically approved by any specific written request prior to the installation of its products. Contact a doctor if for any reason you swallow fog fluid or if after contact with eyes or skin you have any kind of reaction, and in any case wash it immediately with water and soap. Do never stay for a long time in a room filled with fog. Do not use charged bags that are not the ones suggested by **NEBUCLEAN** and never try to recharge them, they are made for a single use. Follow your national rules for the dispose of empty bags. Keep **NEBUCLEAN** bags out of reach of babies and animals. The nozzle may be hot and touching it may cause burns. Do not look directly into the nozzle. Never use **NEBUCLEAN** products for any purpose that is not related to protection from thief or robbery (the choice of the conditions of use in case of robbery will be suggested by your security consultant). Never use different fog fluids or add any other substance into the bags. Do not use or keep charged **NEBUCLEAN** machines in vehicles and do never transport **NEBUCLEAN** before 24 hours since it has been shut off. During transport it must be not armed.



Please observe the following instructions for installing NEBUCLEAN:

1. The machine must be installed avoiding to obstruct escape routes.
2. Verify the fog does not limit the visibility near: stairs, landings, moving objects that may cause falls, injuries or any damage to persons.
3. When using the product in multi-storey buildings, if the escape route runs through an area which is protected by a fogging system, it is recommended to install a vocal warning that provides instructions on the behavior to observe.

4. Do not look directly into the nozzle. Do not add any other substance into the bags.
5. The nozzle may reach high temperatures, touch it may cause burns.
6. When NEBUCLEAN produces fog avoid staying closer than 1 meter from the machine.
7. Before testing NEBUCLEAN, remember to report it in advance to the firefighters in your area to avoid false alarms.
8. Remember to put warning labels about the presence of NEBUCLEAN on the windows.
9. Report its installation to the firefighters in your area and to other institutions if needed.
10. It is necessary to add an external switch to separate the fog generator from the alarm system and it should be activated before the maintenance to avoid that input tests, for example, can activate the fog generator.
11. Never direct the fog jet towards an object or a wall less than 2 meters away and if possible increase the suggested minimum distance. Thanks to the power of the jet, NEBUCLEAN reaches and exceeds more than 10 meters away in the first 3 seconds from the point where the machine is installed.
12. Setting the shooting time interval between the minimum and maximum shown in the shooting table, avoid "overshooting" even if the produced fog is dry and generally doesn't leave residue. A shot that goes far beyond the recommended seconds can create a residue problems in the room.
13. Install at an height of about 2,5 meters not to let it be reached, avoiding possible tampering.
14. Do not move the machine when it is still hot.
15. The main body of NEBUCLEAN, which has the heating system enclosed inside a metal frame, should not be opened unless by specific and authorized service centers. Do not open and touch for any reason the insulation before 24 hours NEBUCLEAN has been shut off. The internal part may reach really high temperature.
16. Do not activate the NEBUCLEAN machine before the installation is completed.
17. Insert the fluid bag as the last procedure and verify the anti-tampering function.
18. When the installation is finished, always test the system.
19. Install NEBUCLEAN avoiding any obstacles in front of it which can prevent the spreading of the fog.
20. The tip of a stranded conductor should not be soft-soldered where the conductor is subjected to contact pressure.
21. The NEBUCLEAN machine should not be exposed to water spray or dripping.
22. Request to take part in courses for installers to ensure the optimal installation of the equipment.
23. The content of the bags is mechanically predetermined and can be subject to variations +/- 10%

DEFECT FOUND	POSSIBLE CAUSE	POSSIBLE SOLUTION
Unit ARMED (BLUE LED ON) but don't execute trig command	Red front led ON	Bag changed ,reset needed Follow instructions Paragraph 13 Empty bag- replace it following instructions on Paragraph 13
	Green front led is OFF	Unit still warming , wait max 120min. with the unit connected to the mains power.
	Wires error	Verify on J10 that when alarm is ON there is a contact between - GND(6) + TRIG(8)
	Mains power overload	Try the Recover procedure(Paragraph 16) With no results replace the board
	Electronic Board overheath	Clean air flow holes (Paragraph14)
Unit cannot be ARMED BLU LED OFF	Wires error	Verify on J10 that when alarm is active there is a contact between - GND(6) + ARM(7)
While setting shooting time the green LED lights once.	The W1 jumper is OPEN , unit in' "RESET" mode	WARNING !!! THE SHOOTING TIME value was resetted. Refer to bag Reset (Paragraph12) and shooting time setting (Paragraph 11)
		See time setting (Paragraph 11)

DEFECT FOUND	POSSIBLE CAUSE	POSSIBLE SOLUTION
Small fog flow coming out from nozzle	All products are 100% and a small amount of liquid could be still in the warming unit Check power input DC12v	This condition is normal and can happen on first installation , it will completely disappear in a while when the unit will become completely hot. Verify the output from power supply (see paragraph 14)
RED Led ON (Error)	Too low battery level or exhaust	Replace Battery
	Bag in Reserve or Empty	Replace fluid Bag
	No Mains power	check mains power or F4 fuse
RED Led ON(Fault)	Disturbance/ interference or potential differences between devices	In the evenience of high noise on mains power (lightings) an error while reading thermocouple values can occur. Execute recovery (Paragraph 16). If even recovery fails the unit may be faulty
		In very large installations or with more than one fog units connected to the same alarm panel , a mains power difference can occur , in that evenience the units have to be decoupled
	Error in the thermal loop	Error on thermocouple, fuse cable , resistor. Please refer to technical service
	Heater Temperature too high or thermocouple error	Switch off the unit and verify the screw on J8 connector
	Poor ventilation	Switch off the unit and clean air holes

	NEBUCLEAN200	NEBUCLEAN300	NEBUCLEAN400	NEBUCLEAN500
Weight without bag	7,5 Kg	8,0 Kg	8,5 Kg	8,5 Kg
Max fog emission in a single shot	200 m ³	300 m ³	400 m ³	500 m ³
Total fog emission capacity with full bag	850 m ³	850 m ³	1275 m ³	1275 m ³
Fog bag capacity	1 x 500 ml	1 x 500 ml	1 x 750 ml	1 x 750 ml
Working time without mains power	1 Hour	1 Hour	1 Hour	1 Hour
Max power on heating system	170 W	170 W	280 W	280 W
Average power consumption during heating	170 W	170 W	280 W	280 W
Heating time	about an hour	about an hour	about an hour	about an hour
Average power consumption	37 W	37 W	48 W	48 W
Maximum current consumption at 12 V	1,2 A	1,2 A	1,8 A	2 A
Battery type (not included)	Pb 2 Ah 12V	Pb 2 Ah 12V	Pb 2 Ah 12V	Pb 2 Ah 12V
Door tamper	n/a	n/a	n/a	n/a
Anti-tear off and anti-shift	n/a	n/a	n/a	n/a



The “empty” signal shows that the unit is still capable of performing a full shot at full capability. However, it is recommended to always have at disposal a further recharge and to proceed at the substitution as soon as possible.

WARNING :

- Do not disconnect the machine immediately after the shot
- Change the battery every two years
- Change the bag as soon as the “empty” signal appears
- The generator cannot be activated on a surface that does not allow air circulation from side slots

It is always recommended to secure the fog generator to a wall even when it is placed on a flat surface. The optional bracket, mainly recommended for ceiling installation, can also simplify standard installation, by allowing to use back holes for the passage of cables. An optional orientable module is available for wall mounting. Always verify that the bracket or the support surface are suitable for the weight of the machine. It is suggested not to install the machine behind walls in a limited closed area without a specific ventilation, in order to prevent a possible overheating.



CAUTION: to avoid injuries please securely secure the fogging machine to the wall according to the installation instructions. After removing the machine from the package, unscrew the four screws of the front panel. Remove the front panel and uncover the electrical circuit (hereinafter referred to as PCB), the DC12V power supply, the thermal unit and the fluid bag.

7 ELECTRICAL POWER SUPPLY

The 230V input provides primary power to the heat exchanger and, by the use of a switching power supply, to the electronic board and the pump. The heat exchanger's working time without mains power ensures proper functioning for a certain period of time, depending on the model, even in complete absence of mains power.

The functioning of the electronic part and the pumping system is guaranteed by the 12V 2A battery (not included).

Although the heating element is of 180W, the average power consumption is 170W during heating and between 40W and 60W when operating.



Do not use inverter or UPS if you are not sure that they generate a pure sine wave, not a rebuilt one. Ask please to the UPS manufacturer the correspondence of such features before proceeding with the connection.

- The max current to be considered for the system is 2A
- The connection to the 230V and 110V electricity grid must be performed by a qualified technician.
- Connect the equipment to the electricity grid only after you have completed the installation.
- It is necessary to connect the ground terminal.
- The system must be connected to the mains through an automatic switch (automatic switch, curie C, with $I_h = 10\text{ A}$ and $I_{df} = 30\text{ mA}$,...) with breaching capacity based on the assumed fault current of the fogging system in the sampling point.

PLEASE NOTE THAT, AS ALL POWERED EQUIPMENT FROM THE ELECTRICITY GRID REQUIRING INSTALLATION, IT IS SUBJECT TO COMPLIANCE WITH RULES OF THE COUNTRY IN WHICH IT IS INSTALLED (D.M. 37 January 22, 2008)



**IF YOU NEED TO REPLACE THE FUSE, USE ONLY FUSE WITH THE FOLLOWING SPECIFICATIONS:
Timed Fuse 250v H Type (1500A) CERAMIC BODY FILLED WITH QUARTZ, REF. STD. EN60127-2-3/DIN41660
3,15AH (EXAMPLE OMEGA GT520231)**

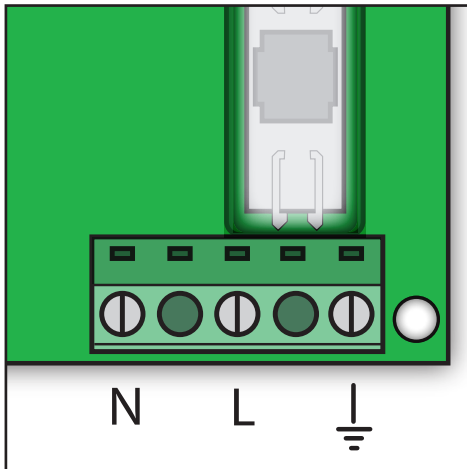

While connecting the machine to the mains power, it is recommended to pay attention to the connection and the screwing of the terminal block screws. The fact of disconnecting or modifying the ground cable voids the warranty and can cause troubles or accidents related to the temperature control.

14 MAINTENANCE

NEBUCLEAN fogging systems don't need special maintenance, nevertheless is suggested a periodical check to the following parts by skilled operators:

- 1) Verify battery and power supply status.
- 2) Verify screws are firmly closed.
- 3) Verify the output nozzle is not damaged and without anything inside.
- 4) Verify pneumatic circuit.
- 5) Verify once a year liquid pump.

BATTERY AND POWER SUPPLY CHECK

Verify that the output of the power supply without any load (battery unplugged) is 14,1 V on the PSU and 13,8 V on FASTON battery connectors. If a different value is noticed, set the trimmer on power supply.

Verify battery status (integrity check, no overheating); it is suggested to replace the battery on 2 years base due to the heavy load during shots without mains power.

SCREWS

Verify that all fixing screws are correctly setted and eventually rescrew them.

OUTPUT NOZZLE

Verify that output nozzle is not damaged and that there is nothing inside blocking the fog ejection flow.

YEARLY PUMP FUNCTIONALITY TEST

The test is done executing a trial shot on the unit. To avoid creating too much fog during the test is suggested to stop the flow after a few seconds dearming the unit under test. The fog flow will immediately stop.

CLEANING THE SYSTEM AFTER USING NCBAG SERIES BAGS

When using NCBAG series bags it is necessary to periodically clean the system: remove the NCBAG bag and mount an NCSP500 cleaning bag instead, set the ejection time to 4-5 seconds and cause an ejection. After cleaning, bring NEBUCLEAN's ejection time back to its previous state and mount the usual bag again.

15 RESET FROM FAULT CONDITION

Disconnect the units from any power source, both mains power and battery must be disconnected. Wait 15 minutes and reconnect the battery and mains power.

This procedure helps to understand if the fault condition was due to mains power overload, serious power supply problems or problems in thermal loop. The fault condition is shown by the RED led ON (LED DL4 on the top), the output FAULT immediately switches and can indicate a transient or fixable condition (Eg. low battery power or no mains power), or a problem that cannot be fixed on site.

WARNING: The RED led (LED DL1, middle of the board), means that unit is ON. It is NOT a fault condition.

On mains power fault or battery low conditions the unit will recover itself without any further operation on it.

In the event that the mains power fault has generated further problems to the unit (Eg. on board fuse) or that the backup battery is not working anymore, the maintenance is needed.

In order to perform the reset, jumper W1 must be opened: open it as shown below.

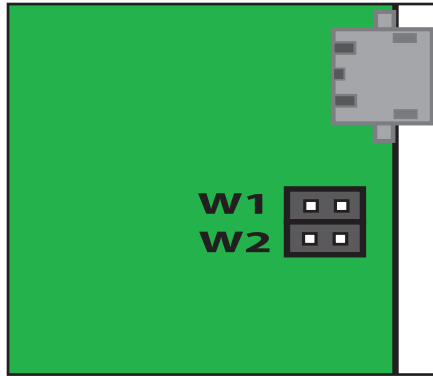

Press and release RESET button (S1) on the board and check the Fault LED resets. Once done, close jumper W1.

13

FRONT LEDS MEANING



SACCA VUOTA
RISERVA

RED LED (right)

ON: Error (Empty bag or low fluid , Mains power off/Battery low) or Fault

OFF : No error condition



ARMAMENTO
ERRORE

BLU LED (center)

ON: Unit is armed and ready to shoot (with green led ON).

OFF: Unit is disarmed , shot not possible.



RISCALDAMENTO

GREEN LED (left)

ON: Unit has reached the correct temperature

OFF: Unit is warming , no shot possible.



The EMPTY signal also means that fluid is going LOW. It means that the unit has shot at least 100 seconds since last reset (NEBUCLEAN200).



The central RED low power light means unit is powered on. The RED FAULT led is on top of the board.

8

POWER SUPPLY CONNECTION

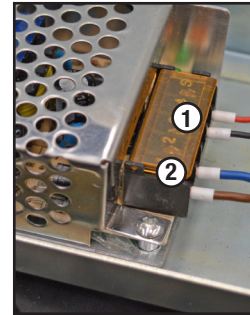

- ①- 12V Power supply connection
- ②- 230V Power supply connection
- ③- 230V Mains power
- ④- Ground connection
- ⑤- Battery slot (battery not included)

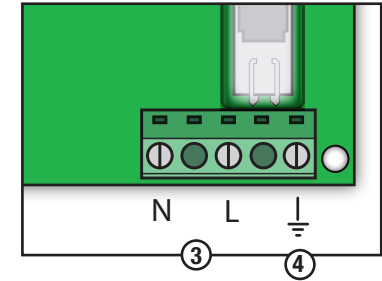

- The battery is essential for the safe use of the device, it is recharged by the board's circuitry
- The predisposition 2A 12V lead-acid battery is lodged below the exchanger
- To gain access to the battery slot it is necessary to remove the plastic front panel and possible stop screw

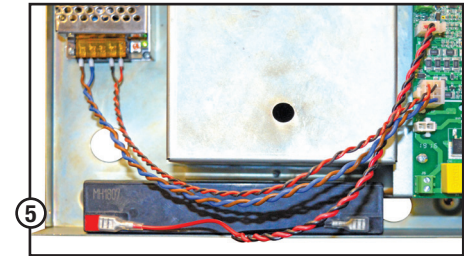

9

DESCRIPTION OF INPUT AND OUTPUT CONNECTIONS

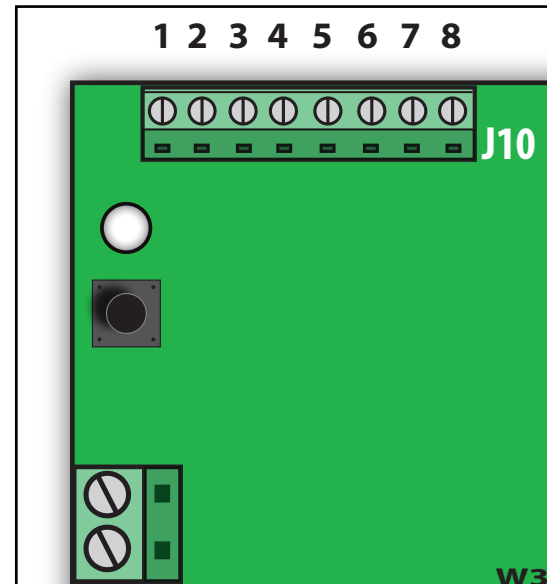

Connection PIN description

DC12V Power supply OUTPUT

- 1 + DC 12V Output (max 300 mA)
- 2 - 0V DC ground connected

OUTPUTS

- | | |
|---------------|---------------------------|
| 3 READY | OC –temperature reached |
| 4 ARM | OC –ready to shoot |
| 5 EMPTY/FAULT | OC –empty bag/faulty unit |

INPUTS

- | | |
|--------|----------------|
| 6 - | GND |
| 7 ARM | Arming input |
| 8 TRIG | Shooting input |

Note: both commands are contact that close towards GND

OUTPUT Power DC12 V

Output DC12v (max 300mA) for electrical connection of local device driven from the board. It can be used to power a local PIR or a remote receiver. It is recommended not to overload the output.

OUTPUTS

EMPTY This Output (NPN Open Collector) closes towards negative when the bag is empty or in reserve.

This signal is activated by a sensor that detects the fluid end only during the shot. The empty bag notification is removed by pressing the RESET button (see chapter 12).

For this reason, if an empty bag or a bag with few amount of fluid will be inserted, the unit will be able to detect this condition only during a shot.

FAULT This Output (NPN Open Collector) closes towards negative when a fault condition that voids functionality occurs. It also activated when maintenance is needed, eg. empty batteries or wrong detections on power supply or temperature sensor. If a power fault occurs it will be self resetted when mains power is back.

It is suggested to connect at least the first two output signals to an alarm panel or other equipment able to forward the signal to whom is concerned.

To avoid false activation wire disconnecting doesn't activate the fog emission, for this reason we suggest to double check the reliability of the connections towards the alarm panel and to protect wires from intentional or potential void. INPUTS

ARMING

Closing the contact ARM: the blue led turns ON and then, if the unit has reached the correct temperature, it is ready to generate fog. Resetting ARM condition immediately stops accidental fog emission.

TRIG

Closing the contact TRIG: If the unit is armed and has reached the correct temperature, it creates fog for the time set. During the shot, if the contact ARM is open, it immediately stops fog generation.

After the shot, all further shot command within 120 seconds will not be processed.

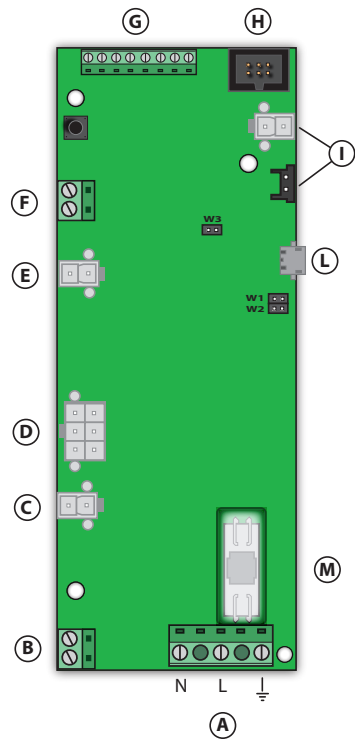

- A) J4 Mains power connection
- B) J5 Heater Resistor
- C) J2 Fuse Cable
- D) J7 Power supply unit 12v
- E) J9 Battery 12v 2A connector
- F) J8 Thermal Sensor connector
- G) J10 Inputs/Outputs connector
- H) J11 RS232 connector
- I) J3 (J6) FogStorm Pump Connector
- L) J1 USB port
- M) F4 Mains fuse

W1 Shooting time setting enable

W2 Reserved (Open)

W3 Reserved (Closed)

Insert the bag in the proper space as indicated in the following picture.



Connect the metal connectors until a "click" is heard.

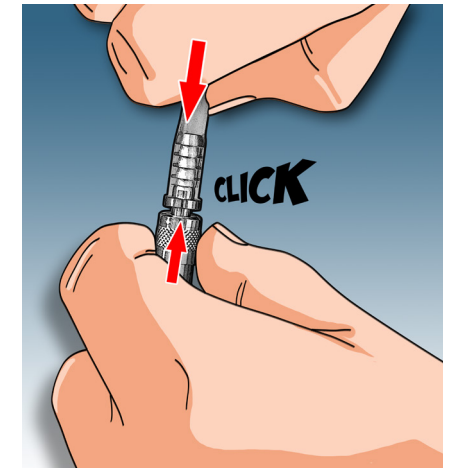
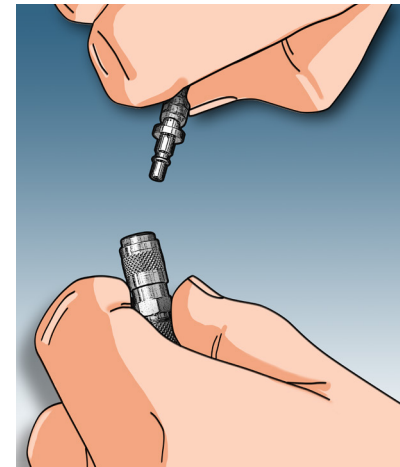

SHOOTING TABLE NEBUCLEAN 200 (max 28 sec.)

m³ to protect	Seconds of emission	m³ to protect	Seconds of emission	m³ to protect	Seconds of emission
50	7	100	14	200	28
75	9	150	21		

SHOOTING TABLE NEBUCLEAN 300 (max 40 sec.)

m³ to protect	Seconds of emission	m³ to protect	Seconds of emission	m³ to protect	Seconds of emission
50	7	150	21	300	40
75	9	200	28		
100	14	250	35		

SHOOTING TABLE NEBUCLEAN 400 (max 46 sec.)

m³ to protect	Seconds of emission	m³ to protect	Seconds of emission	m³ to protect	Seconds of emission
50	6	150	21	300	40
75	9	200	23	400	46
100	12	250	35		

SHOOTING TABLE NEBUCLEAN 500 (max 48 sec.)

m³ to protect	Seconds of emission	m³ to protect	Seconds of emission	m³ to protect	Seconds of emission
50	6	150	16	300	27
75	9	200	21	400	37
100	12	250	24	500	48

The value in the first column indicates the volume of the room to be protected, with respective seconds of emission reported in the second column. The value in m³ varies depending on the density to be obtained. With the suggested value it is possible to get the maximum density recommended to ensure the absence of any residual. In places where a little residual causes no problems, it is possible to increase the shooting time. Please note that the more fog released, the more the time required to recover visibility. High levels of fog, over recommended limits, can leave residual. Any residue usually goes away by itself within 24/48 hours, otherwise, being soluble in water, it is enough to use a wet cloth for cleaning. If you desire to obtain an average of 1 meter visibility after 60 seconds, as specified by the standard EN 50131-8, as used as reference by all manufacturers of Fog generators, the number of shooting seconds it is to be reduced in half.



The diagrams and examples below are intended only for a “better understanding” of the operation of the inputs / outputs. None of the diagrams below represents the “single scheme to perform” as, in respect of the reference standard EN50131-8, there are precise indications and only using all inputs and outputs on the PCB it is possible to abide by the standard.



Is recommended to use the “HOLD-UP” function after a careful evaluation of the risks from a security consultant.

When FAST Nebuclean is ARMED , it becomes immediatly ready to create fog.For safety reasons and to avoid false fog emissions is suggested to program the alarm panel to allow enough time to leave the place.

- A NEBUCLEAN inputs connected to standard alarm panel outputs
- B NEBUCLEAN inputs connected with a clean contact (relays) alarm panel outputs
- C Wiring example of NEBUCLEAN outputs to drive leds and/or relays

A - NEBUCLEAN inputs connected to standard alarm panel outputs

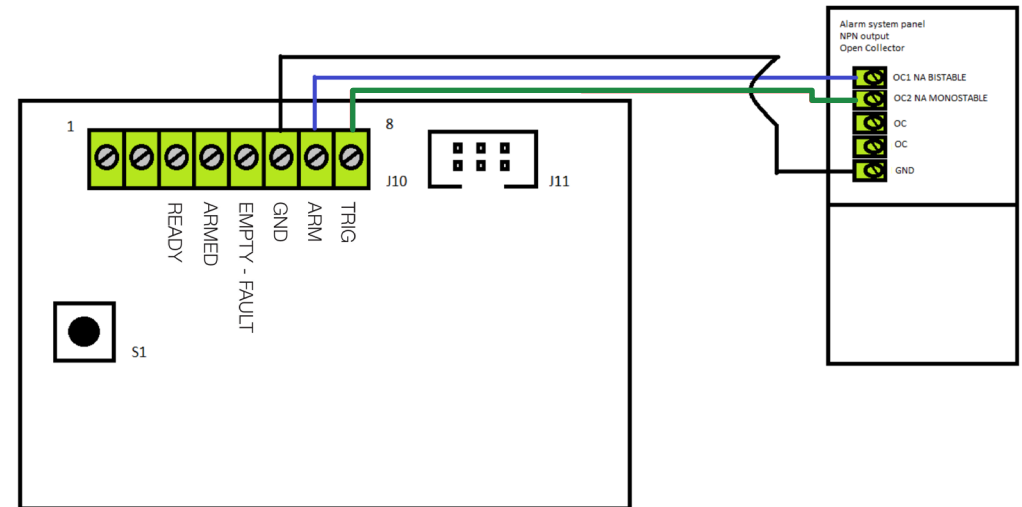

The ON/OFF output of this alarm panel is an Open Collector NPN that is OPEN with the alarm OFF and close to negative for all the time the alarm panel is active and monitoring. The alarm panel output is normally open and close the contact during alarm time.

B - NEBUCLEAN inputs connected with a clean contact (relays) alarm panel outputs

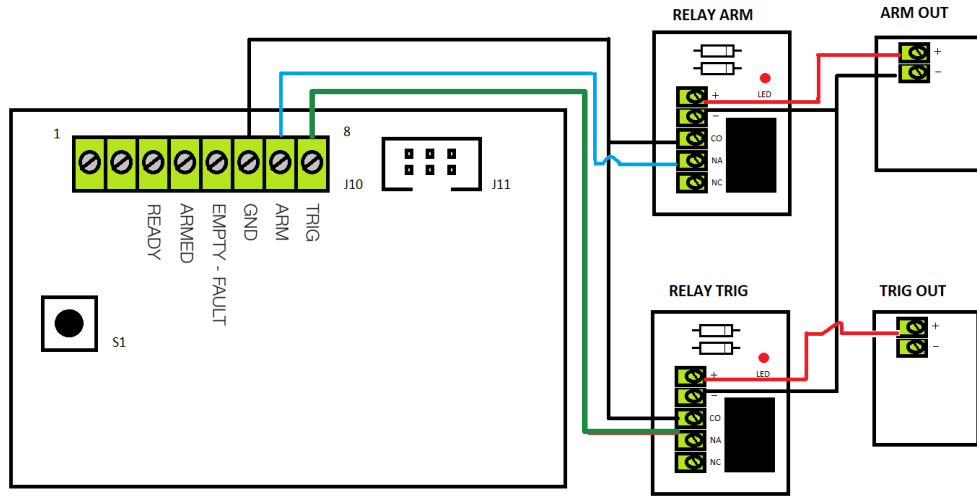

The ON/OFF output of this alarm panel is an open relay when panel is OFF that continuously keep close for all the time the alarm panel is monitoring.
The alarm output of the panel is an open relay that close when alarm condition is detected.

C - Wiring example of NEBUCLEAN outputs to drive leds and/or relays

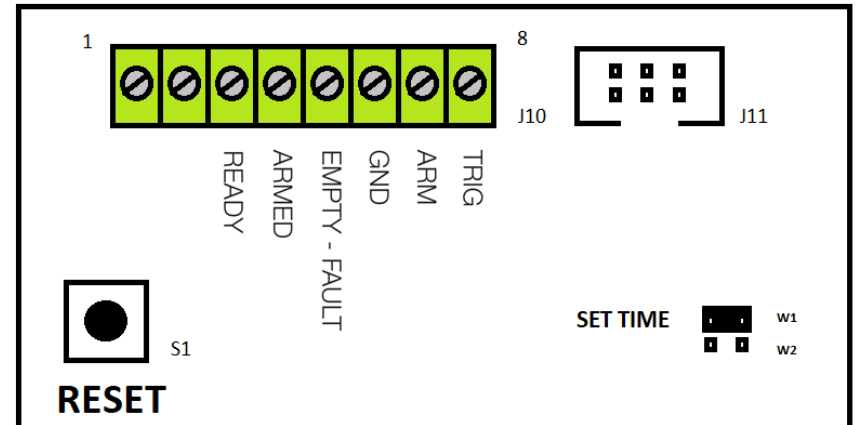
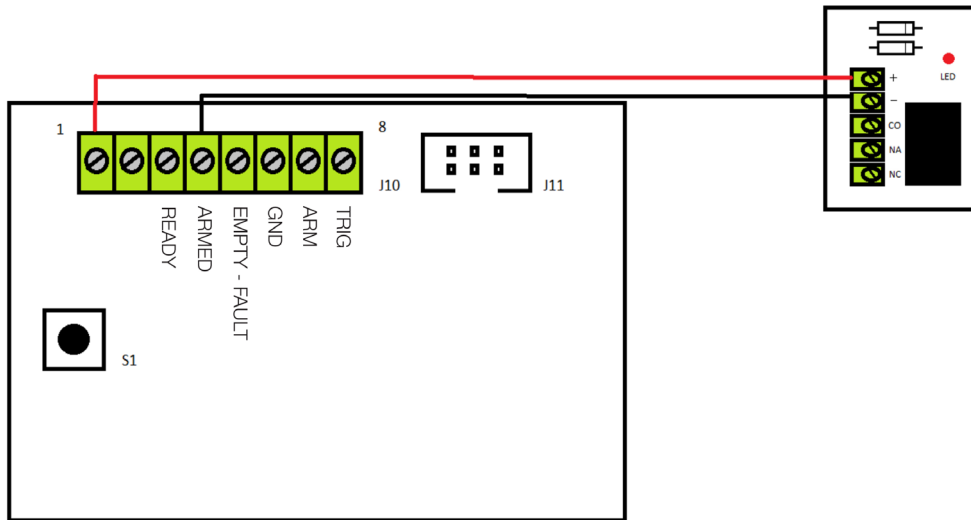

To set the shooting time, after opening the front panel, you must close the jumper W1 in SET position as shown in figure, then, holding down the button S1 "RESET", the green led on the front will flash and each flash is equivalent to one second. If you press the button again, the shooting time is not added to the one previously set, but will restart from zero.
Notice: each blink equals 1 second

If RESET button is kept pressed for a time longer than the shooting time allowed for the unit, shooting time will be set to the maximum.

Shooting time can be set according to desired seconds, but to correctly activate the bag reserve in full security, it must be set minimum 4 seconds of shooting

RECOMMENDED SHOOTING SECONDS ACCORDING TO THE VOLUME SPACE TO PROTECT (m³)

Fogging systems NEBUCLEAN are able to produce fog based on second by second setting.. The maximum quantity of 5,6 ml/s (NEBUCLEAN 200) allows to fill an area of about 200.

There might be cases in which, due to specific characteristic of the location, nozzle type, levels of temperature and air pressure, degree of the fog density and light in the target area, the shooting time can be increased or decreased. For example, above 5mt of height the shooting time must be integrated and above 7mt , every additional meter should be considered as double.

$$(H \times L \times P) \times D \times V \times R \times I$$

- H×L×P -----Height × Width × Depth of the area to protect
- D-----Density of the produced fog
- V-----Temperature and air pressure
- R-----Acceptable residue in case of saturation of V parameter
- I-----Intensity of the surface light

The following tables indicate the suggested fog emission in relation to the number of seconds of shooting set in average condition of temperature, air pressure and humidity.

To correctly dimension the machines it is needed to verify that the saturation of the area occurs in faster time than the one supposed for the theft.