

- 230 Vac control unit with inverter
- 230 Vac for three-phase motors with delta connections

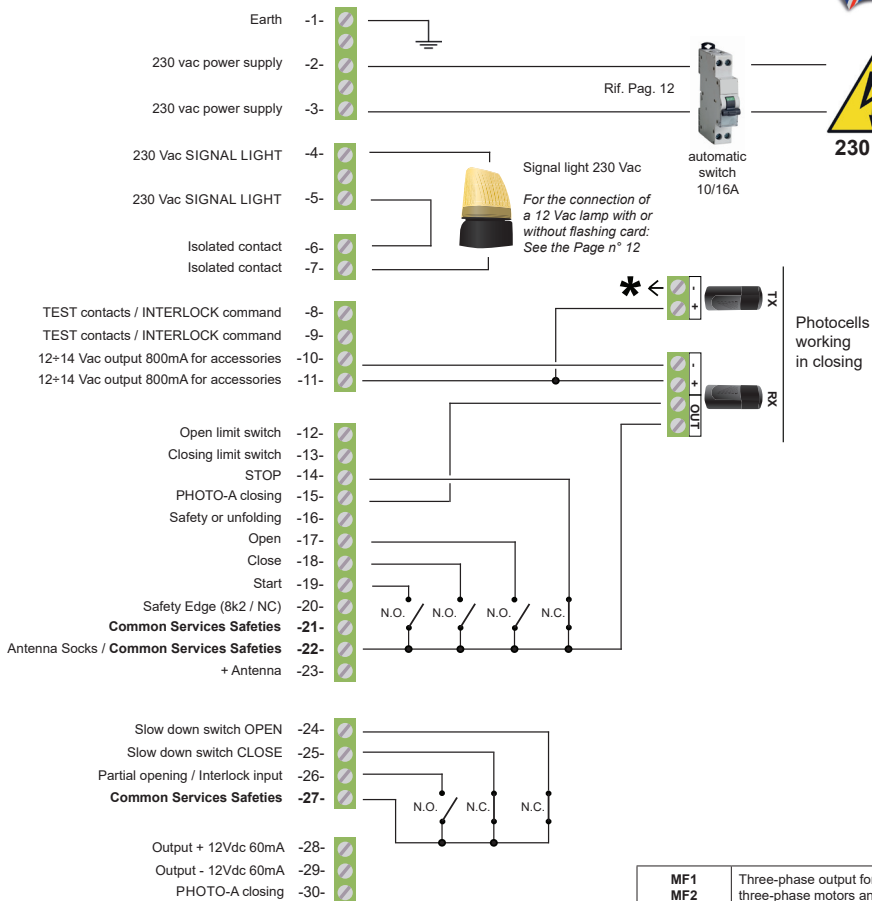

START-S12-M

Instructions and warnings for the installer



MF1 MF2 MF3	Three-phase output for three-phase motors and "delta" connections
FR1 FR2	Output for brake

* Connect this point to terminal no. 8 for the photo-test. Otherwise connect it to the terminal board no. 10



Foreword

This manual provides all the specific information you need to familiarize yourself with and correctly operate your unit. Read it very carefully when you purchase the instrument and consult it whenever you have doubts regarding use and before performing any maintenance operations. Nologo has the right to modify the product without previous notice.

Environmental protection measures

Information regarding the environment for customers within the European Union. European Directive EC 2002/96 requires that units bearing this symbol on the unit and/or on the packaging be disposed of separately from undifferentiated urban wastes.



The symbol indicates that the product must not be disposed of with the normal household wastes. The owner is responsible for disposing of this product and other electrical and electronic equipment through specific waste collection facilities indicated by the government or local public agencies. Correct disposal and recycling help prevent any potentially negative impact on the environment and human health. To receive more detailed information regarding disposal of your unit, we recommend that you contact the competent public agencies, the waste collection.

Small legend

LSO or FCA	Open limit switch
LSC or FCC	Close limit switch
START	Control to drive the gate
PEDESTRIAN	in sliding units: control partial opening
Vac	(alternate current) corrente alternata
Vdc	(discrete current) corrente continua
NC	normally closed
NA o NO	normally open
Isolated contact	isolated from power supply





Index

Par.	Description	Pag.
1	Scheme of the control unit / wiring diagram	6
1.1	Description of the electrical connections	7
2	Use and functions of the control panel	8
2.1	State of the control unit	
2.2	Settings and parameters	
2.3	Example how to use the MENU and information	9
2.4	Set up a password for programming	10
2.5	Cancel of the operation	11
2.6	Display the number of cycles and the speed of the motor	
2.7	Deactivation of the cycle when the control panel will be turned on	
2.8	Opening/ Closing in case of emergency	
3	Installation of the control unit	12
3.1	Connection of the TENSION and MOTOR	
3.2	Connection of the lamp 230 Vac or 12 Vac	
3.3	PRE-FLASHING time	
3.4	Connection of the ANTENNA	13
3.5	STOP connection	
3.6	Connection of the 8k2 safety edge or N.C.	
3.7	Connection of the Open and Close limit switch	
3.8	The connection of partial opening or START	14
3.9	Connection of the PHOTO-BEAMS with cable	
3.10	CONNECTION of the safety or UNFOLDING FUNCTION	
3.11	Connection of the PHOTO-BEAMS	15
3.12	Connection of the photo-beam (activated when closing) with TEST	
3.13	Deactivation of the PHOTOCCELL A	
3.14	SLOW DOWN SWITCH	16
3.15	Connection of the brake and internal brake	
4	ACTIVATE the single OUTPUTS	17
5	Functions	18
5.1	Logic of functions	
5.2	Working time	19
5.3	Set SPEED and ACCELERATION	20
5.4	SCHEME relation between SPEED and FREQUENCY of the motor	21
6	INTERLOCK Function	22
7	RESET of the control unit and restore of factory default settings	23
7.1	Restore factory settings	
7.2	WARNING of the SETTING PARAMETERS	24
7.3	SAVE SET UP and CHECK of the parameters	
8	LIST of the FUNCTIONS	26
9	Problems	29
10	Note	30
11	Declaration of CE conformity	31

Safety precautions

We remind that the installations of gates and automatic doors must be executed from qualified personnels according to the norms. Before installing check the strength and mechanic part of the gate or door, check that the mechanical stops are suitable to stop immediately the cycle of the gate or door even in case of faulty limit switches or during the manual cycle. For your security we recommend to install a STOP switch when activated it stops immediately the gate. The switch has a N.C. opening in case is activated (as shown in par. no. 3.7)

Symbols and warning

	<p><u>Dangerous</u></p> <p>This is a warning and if it is not respect it can provoque material damage</p>		<p><u>Damage</u></p> <p>For safety reasons, protect your face during the connection</p>
	<p><u>Device under tension</u></p> <p>The installation should be done only from professional installer</p>		<p><u>Read carefully the operating manual</u></p> <p>Read carefully this manul before installation and keep it for the future</p>
	<p><u>Dangerous for overheated surface</u></p>		

Network filter for CE norms

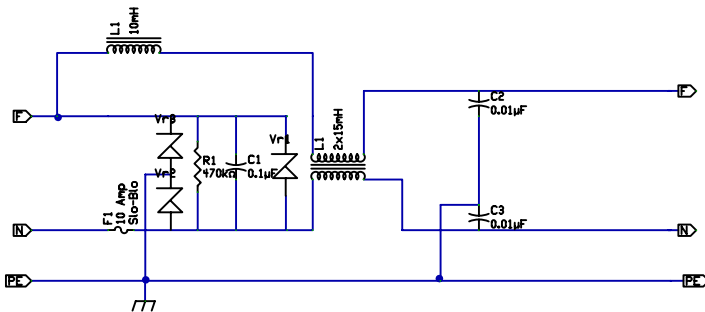



FILTER-S12
 Option for CE Norms

Type of installation

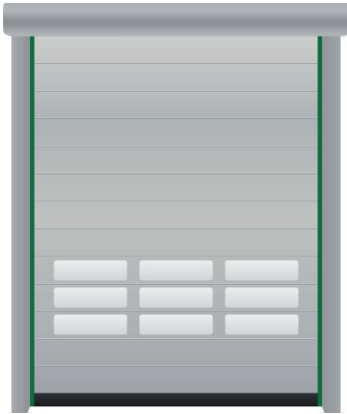
The control board START-S12-M can be used for Industrial rapid doors and for sliding automation with threephase motors (delta connection) up to 3 Hp with ventilation systems.

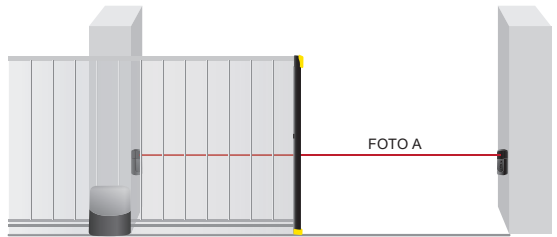

Rapid doors



Sliding automation

Check the software version and compatibility with the operating manual

When the control unit is turn on, you can see 4 numbers in the display. This is the software number. We suggest to check this number with the version on the manual. (see pic).

CODE

1725

Vers. firmware 1725

Check that the number on the display correspond to the firmware on the operating manual.

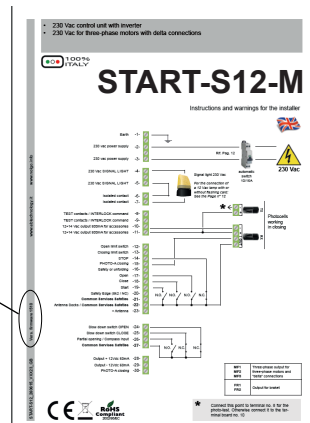

1 Scheme of the control unit

LED POWER ON
Indicates the network power



WARNING!

We remind you that the safety devices, accessories should be installed when the control unit is not powered.

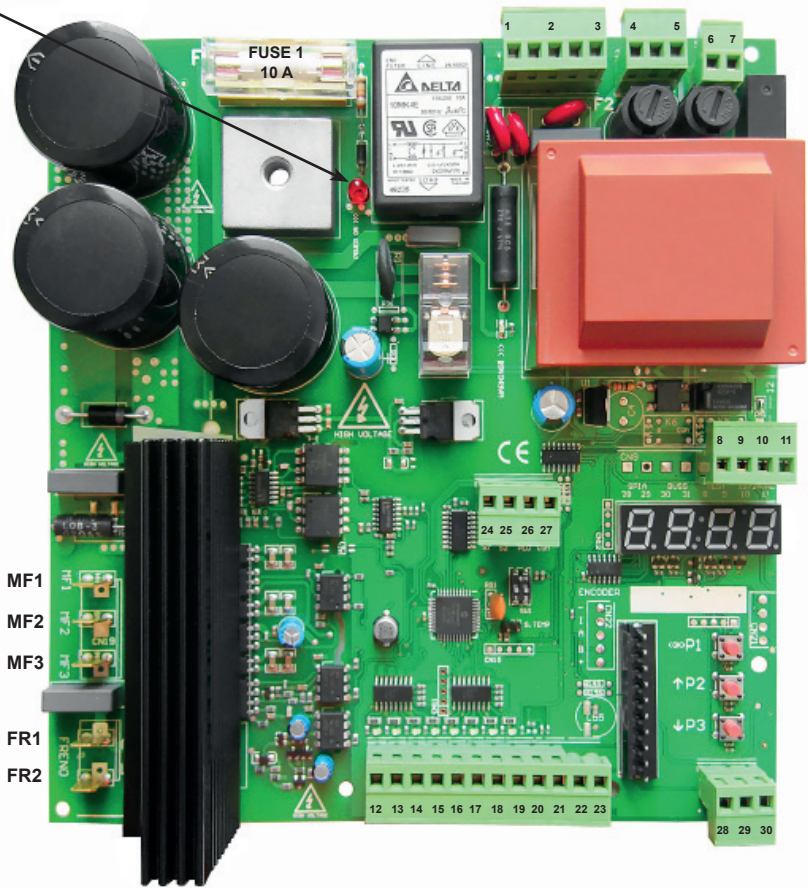

P1 P2 P3 Set the control unit

DIP not used

JP1 Connector for temperature sensor

F1 Fuses protection motor and power: 10A

F2 Fused protection terminal boards (4, 5): 1.6A

F3 Fuses for power supply for accessories and safeties: 200mA

MF1-2-3 Three-phases output for 230Vac motors delta connection

FR1-2 Output for brake motor

LED WARNING Indicates that the capacitors are still charged, before taking the central wait until the LED turns off.

The **red led** in the input **LSO-LSC-STOP-PHOTO-UNFOLDING EDGE** are always lit on
The **green led** in the inputs **OPEN-CLOSE-START** are normally lit on

LSO	LSC	STOP	PHOTO	UNFOLDING	OPEN	CLOSE	START

WARNING: If the inputs are deactivated from display with **S13, S14, S15, S16, S17** red leds are **SWITCHED OFF**

Recommended wiring diagram

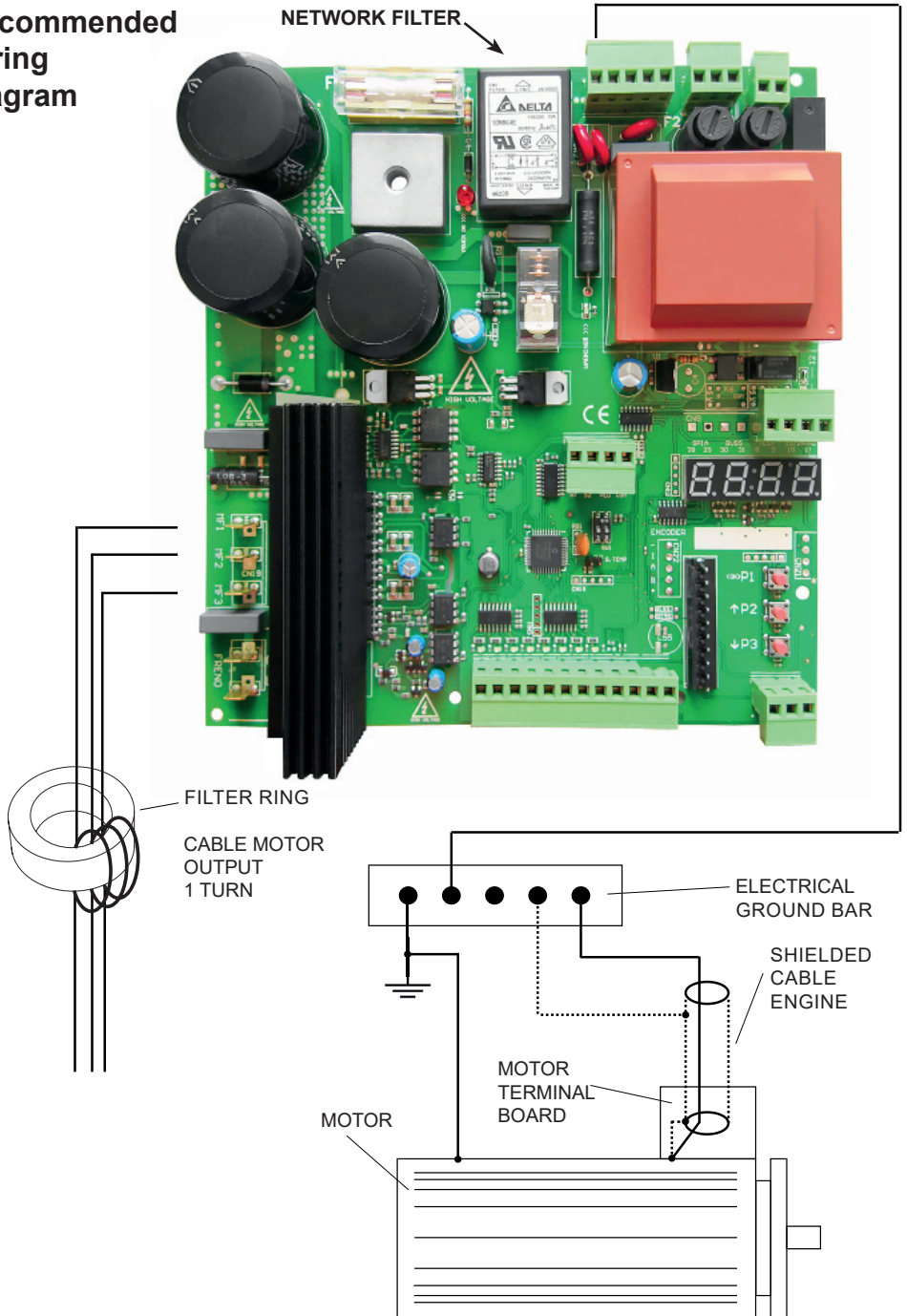

1.1 Description of the electrical connections

Earth	1		Earth
230 Vac (N)	2		230 Vac 50Hz, power supply, neutral
230 Vac (L)	3		230 Vac 50Hz, power supply, phase
Signal light	4		230 Vac Signal light Max power 40 W <i>For the connection of a 12 Vac lamp or 230Vac signal lighth: See the par 3.2, page number 12</i>
	5		
	6		
Signal light	7		
Test	8		Isolated contact for TEST / Interlock command
Test	9		Isolated contact for TEST / Interlock command
Out 12 Vac	10		12÷14 Vac output 800mA for accessories
Out 12 Vac	11		12÷14 Vac output 800mA for accessories
LSO	12		Open limit switch
LSC	13		Closing limit switch
Stop	14		STOP
Photo A	15		PHOTO-A closing
Safety edge	16		Safety or unfolding
Open	17		OPEN
Close	18		CLOSE
Start	19		START
Costa	20		SAFETY edge - NC / 8k2 contact
Common	21		Common Services Safeties
Common	22		Antenna Socks / Common-Services-Safeties
+ Antenna	23		+ Antenna
Switch Slow OP	24		Slow down switch OPEN
Switch Slow CL	25		Slow down switch CLOSE
Pedestrian	26		Partial opening / Interlock input
Common	27		Common Services Safeties
Out + 12 Vdc	28		Output + 12Vdc 60mA
Out - 12 Vdc	29		Output - 12Vdc 60mA
Photo A	30		Photo-A closing

2 Use and functions of the control panel

START-S12-M has a display for a simple and fast programming. The menu has been designed for a clear and fast set up of the working time and the logic of the control unit. You can set up the control unit only when the door is closed.

2.1 State of the control unit

If you don't press any button, the display shows the position and the temperature of the heat sink.

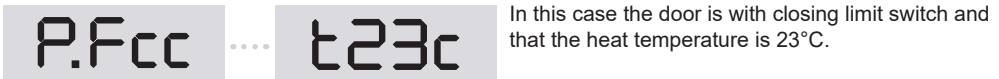

2.2 Settings and parameters

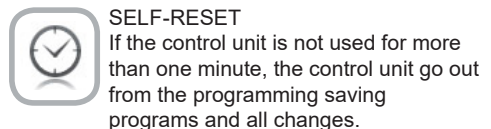
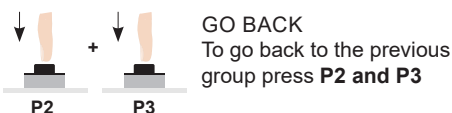
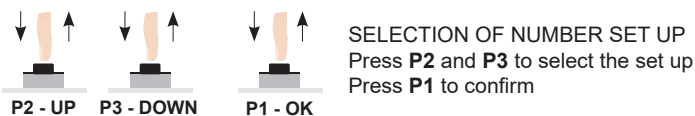
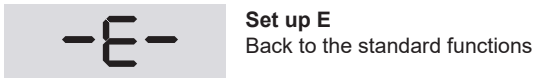
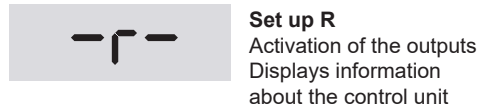
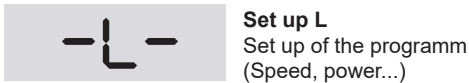
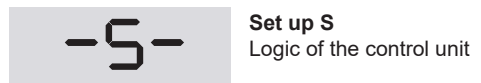
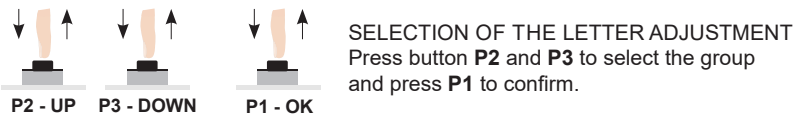
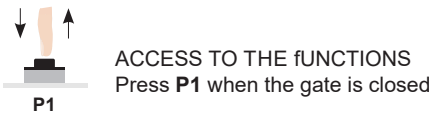

2.3 Example how to use the MENU and information

You can read the information through a display: you can read if it is working properly, the manoeuvre counter and the sink temperature. Some information can be shown only on the **R** function (see Chapter no.4)

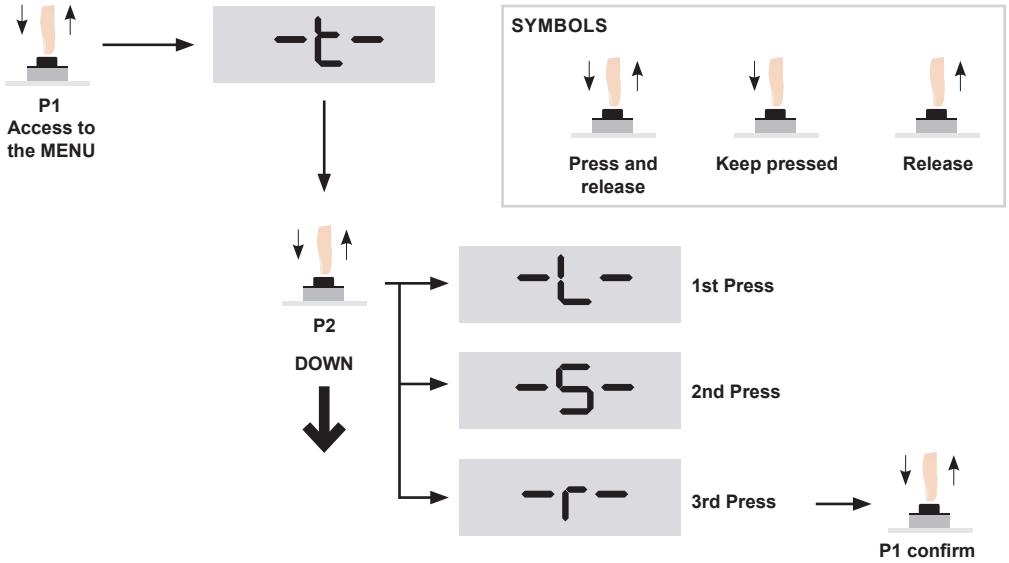

In the function **R** if you press **P1**, you can choose the group function: first select **P2** and **P3** and then confirm with **P1**. Now you can go to the function **R07**, **R08**, **R09** and **R10**

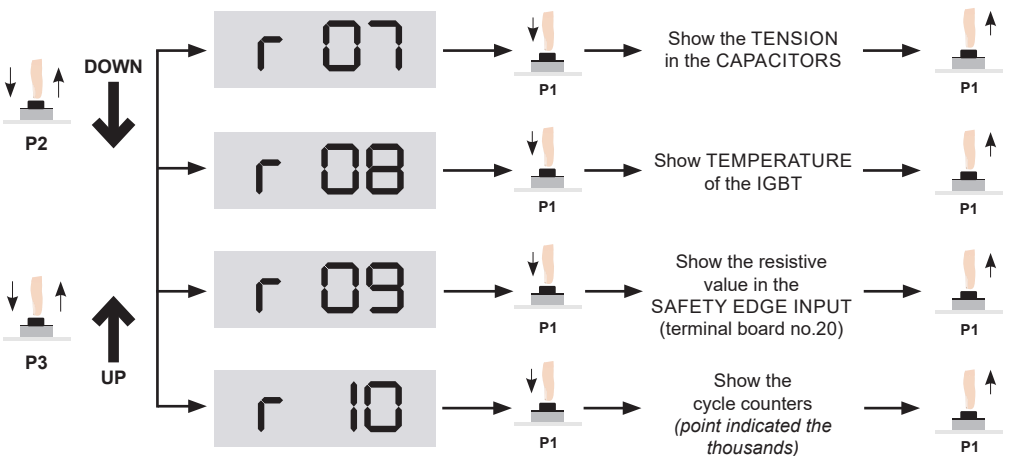

2.4 Set up a password for programming

To save all changes it is possible to select a password of 4 numbers. To activate this function make as follow:

• PASSWORD ACTIVATION:

Press **P1**, **P2** and **P3** in the function **S32** and then confirm with **P1**.

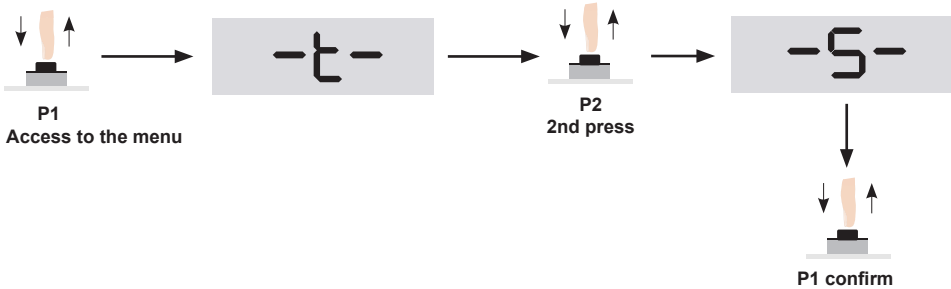

In the function **S** if you press **P1**, you can choose the group function: first select **P2**, now you can go to the function **S32** and then confirm with **P1**.

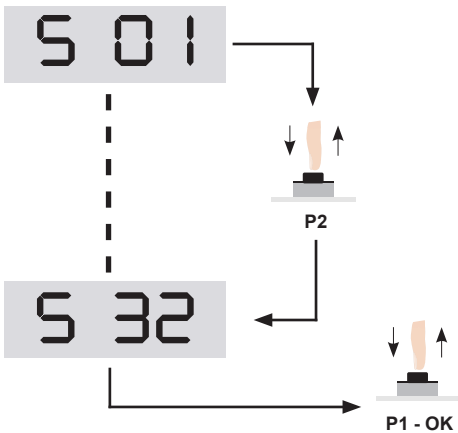

• INSERT PASSWORD

Choose the first number with the buttons **P2** and **P3** then confirm with **P1**. The same procedure applies to the other digits.



finished entering the 4 digit. Press **P1** to confirm. To cancel press **P1**, within 10 seconds. Otherwise, the next access will be required the security code.

! Pay attention in case you forget the password it is not possible to enter in control board as well.

• DEACTIVATION OF THE PASSWORD



If you select the function no. **S33** you can cancel the password. Wait 10 seconds to confirm the operation.

2.5 Cancel of the operation

When you confirm the operation you can read the following message to cancel the operation. If you press **P1** in 10 seconds, this operation will be cancelled.



2.6 Display the number of cycles and the speed of the motor

• CYCLE COUNTER



P3

It is possible to show the number of cycles even pressing **P3** (*expressed in ten cycles*)

The counter counts up to 999'999 openings. The display shows the first 4 most significant digits.

344.2

If you read these number, it means that the installation has made 344200 cycles.

• MOTOR SPEED



P1

Press **P1** when the door is open, the display shows the **SPEED** of the MOTOR

2.7 Desactivation of the cycle when the control panel will be turned on

When the tension has been interrupted and you turn on the control board again it will make a new cycle. To exclude this operation make as follow:



P1

DEACTIVATE THE COMPLETE CYCLE OF THE CYCLE FUNCTION WHEN THE TENSION HAS BEEN INTERRUPTED: keep pressed **P1** when turns on.

2.8 Opening / Closing in case of emergency

We add this function for START-S12M for emergency open and close even in case of test for installation. **Pay attention that the control unit will exclude the securities (photocells, barriers, limit switches etc)**

To open or to close press and keep pressed the button STOP and then keep pressed for at least 5 seconds the button OPEN and CLOSE connected to the terminals 17 and 18.

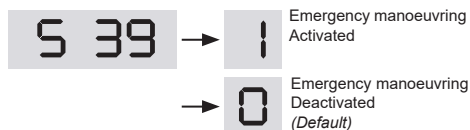

To avoid abnormal openings problems, follow either of the connections:

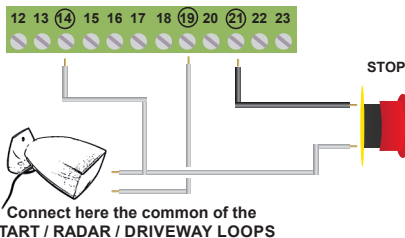

3 Installation of the control unit

3.1 Connection of the TENSION and MOTOR POWER SUPPLY

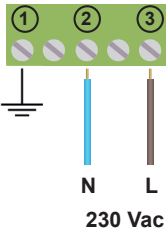

• The control unit is equipped with a network filter

We recommend:

- Install an automatic switch 10/16A
- Check the network power: 230 Vac: -5% +10%



THREE PHASE MOTOR “DELTA” CONNECTION

It is recommended to use shielded cables

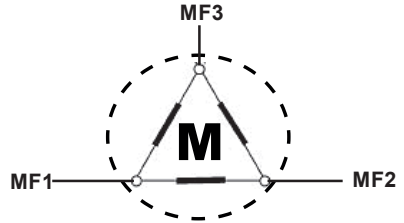

3.2 Connection of the lamp 230 Vac or 12 Vac

It is shown the connection of a **230V** lamp with or without flashing card.

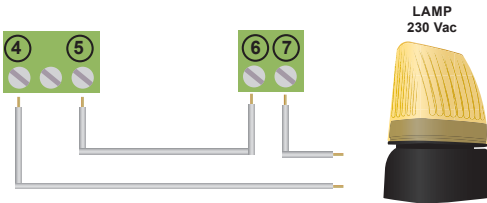

LAMP
230 Vac

• SET UP OF THE LIGHTING

In case the lamp has no flashing card, set **S12** in 1:

S 12

FLASHING
1 - Activated (*standard*)
0 - Deactivated

• LAMP IN PAUSE TIME

To activate the function lamp in pause TIME, set **S05** as shown:

S 05

LAMP IN PAUSE
1 - Activated
0 - Deactivated (*standard*)

It is shown the connection of a **12 Vac** lamp with or without flashing card.

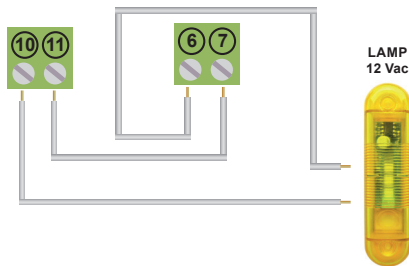

LAMP
12 Vac

3.3 Pre-flashing time

It is possible to increase or reduce the time of pre-flashing when the door is closed or open, make as follow with **T07** and **T08**:

t 07

PRE -FLAS HIN G TIME WHEN THE DOOR IS CLOSED
From 0 to 10 s
Standard value 0.5 s

t 08

PRE-FLASHING TIME WHEN THE DOOR IS OPEN
From 0 to 10 s
Standard value 2 s

3.4 Connection of the ANTENNA

In case the antenna is only a cable of 17cm for 433.92Mhz, connect it to the terminal board no. 23.

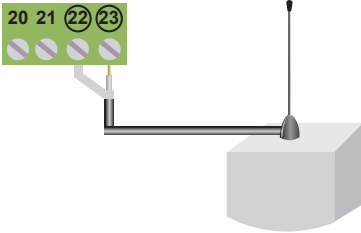

3.5 STOP connection

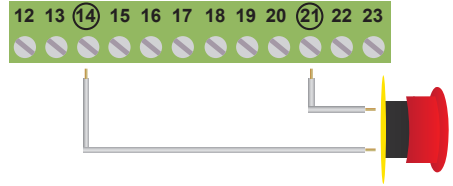

Button: Stop until a new command
Switch: it keep the automation stopped until a new command

S	15	STOP
		1 - Activated
		0 - Deactivated

The connection of the safety devices is prevued with a button or a normally closed contact
More devices should be connected in parallel.

3.6 Connection of the 8k2 safety edge or N.C. contact

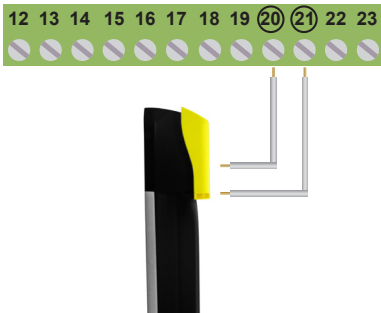

Connect the safety edge at terminal board no. 20 and 21

S	22	SAFETY EDGE
		1 - Activated (<i>Standard</i>)
		0 - Deactivated
S	38	SAFETY EDGE contact
		0 - NC contact
		1 - 8K2 contact (<i>Standard</i>)

3.7 Connection of the Open and Close limit switch

The picture shows the connection of both limit switches but you can connect it separately. You can use only LSO or only LSC.

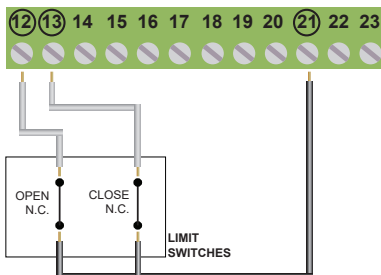

S	13	LSO
		1 - Activated
		0 - Deactivated
S	14	LSC
		1 - Activated
		0 - Deactivated

! *If the input LSO & LSC is not used, set S13 & S14 in 0*

3.8 The connection of PARTIAL OPENING or START

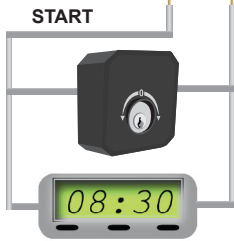
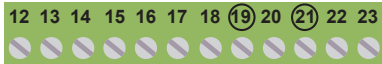

The connection of a START command can be done with a button or with a N.O. contact. When more devices are available, connect them in parallel.



Partial OPENING

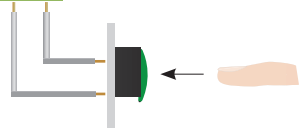

The connection of PARTIAL OPENING can be done with a button or a normally open contact.

It is possible to connect a timer in the terminal board no. 19 and 21 to program the opening time of the gates. The contact of the timer should be normally open (N.O.) and it should be closed for all the time the gate is open. If the connection of opening command is available in the terminal board no 19, connect it in parallel.

3.9 Connection of the PHOTO-BEAMS with cable (only when closing)

The terminal boards 28-29-30 are available for the connection of the photo-beams with cable like IRPA 1/ SENSOR-3DD. You can see a standard installation:

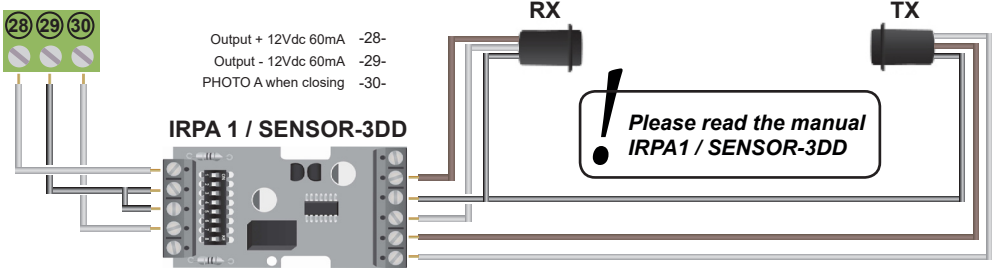

3.10 CONNECTION of the safety or UNFOLDING FUNCTION

In case the control units is installed in rapid-rise-doors is possible to connect photobeam for unfolding the curtain. In case the intervention of safeties, the doors stops and reverse the cycle of 1.5sec.

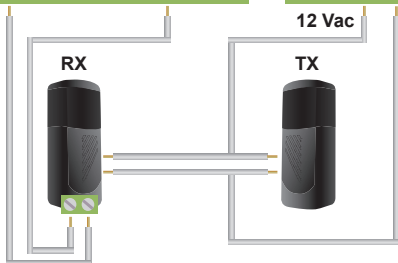
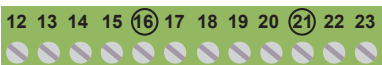

NC Contact



INPUT UNFOLDING
1 - Activated
0 - Deactivated

! *If the input is not used, set S17 at 0*

The connection of more safety devices can be done with each button or a N.C. contact. More safety devices should be connected in serial.

3.11 Connection of the PHOTO-BEAMS (only when closing)

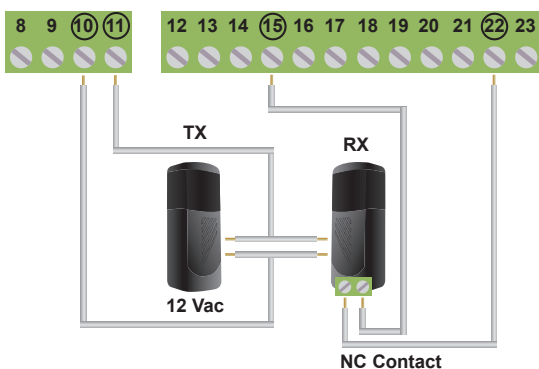

The contact of the receiver should be:
 - **Isolated** (*isolated from tensions*)
 - **Normally closed**

! *If the input PHOTO is not used, set S16 in 0*

3.12 Connection of the photo-beam (activated when closing) with TEST

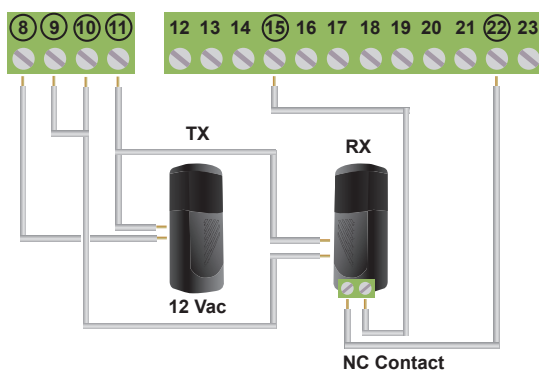

The TEST of the photo-beam works only if the photo-beams are installed properly. The control unit will check all connections before opening!

In case the photo-beam are not working properly the control unit will lit on for 5 seconds and the gate is not moving.

If you go back to function without TEST, do the connection as in Par. 3.08 and put in **0** the **S06** and **S09** (*deactivate if are inputs are not in test*)

To activate the **TEST** set **1** in the **PHOTO-A**:

5 09 TEST IN PHOTO OUTPUT
 1 - Activated
 0 - Deactivated

5 06 TEST IN THE INPUT SAFETIES
 1 - Activated
 0 - Deactivated

3.13 Deactivation of the PHOTOCCELL A when the gate is closing

5 03 Photocell A deactivated
 1 - Activated
 0 - Deactivated

If you set S03 it deactivates the PHOTO A after intervention of slow down LS. If **S03** is **1** the time of function **T11** is not considered

3.14 SLOW DOWN SWITCH

For the beginning of the slow down it is possible to connect the switch OPEN and CLOSE. Connect the switch to terminal board no. **24-25-27** as shown in the pic. The switches are not installed, the slow down can be programmed with **T03** (open) and **T04** (close).

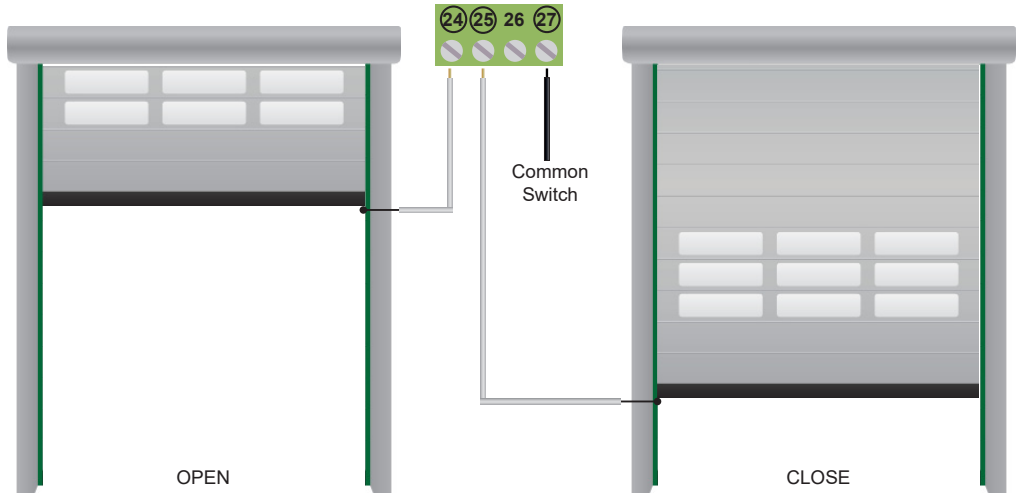

S 20 Switch input when OPENING
 1 - Activated (Standard)
 0 - Deactivated

S 21 Switch input when CLOSING
 1 - Activated (Standard)
 0 - Deactivated

3.15 Connection of the brake (FR1-FR2) and internal brake

Pay attention when you connect the brake and pay attention of the polarity. Program with **S19** according to the type of brake:

S 19 POLARITY OUTPUT OF THE BRAKE
 0 - brake deactivate with tension (Standard)
 1 - brake activate with tension

You can activate the INTERNAL BRAKE (S37), activating this function, the internal brake is activated for 2 seconds after engine shutdown.

S 37 INTERNALE BRAKE

1 - light deceleration	5 - no aceleration, no brake
2 -	6 - light braking
3 -	7 -
4 - high deceleration	8 -
	9 - high braking

4 ACTIVATE the single OUTPUTS

START-S12-M can open and close separately and the outputs for lamps and test. This is useful in case you want to check the single outputs.

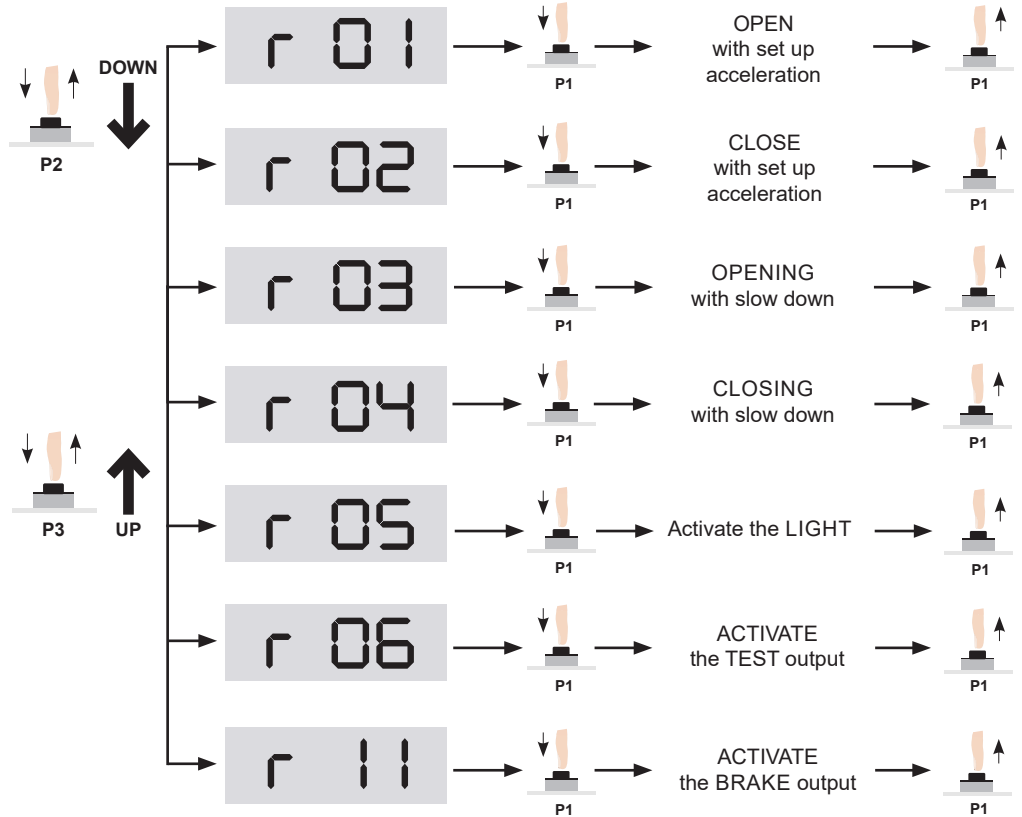
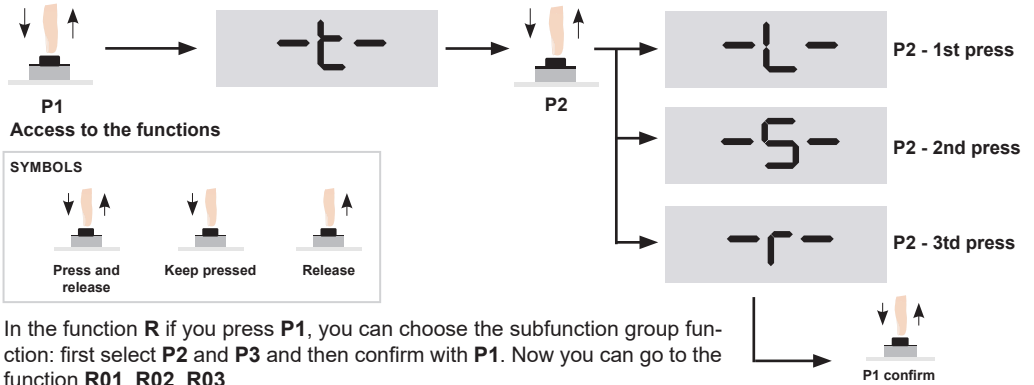

5 Functions

5.1 Logic of functions

Imp. N°	Val.	Functions	Description
S 01	1	Signal Reverse	By each START command inverts: OPEN-CLOSE It recloses automatically
	2	Automatic	The START command can open or recharge the pause time. It recloses automatically
	3	Bistable function	By each START command it follows: open-stop-close-stop-open... It doesn't recloses automatically
	4	Stable function with automatic reclosing after pause time	By each START command it opens-stops-closes-stops-opens... It recloses automatically after pause time
	5	Signal reverse + Dead-man function	Same as function S01 - 1 OPEN and CLOSE with "Dead-man function" function
	6	Collective use + Dead-man function	Same as function S01 - 2 OPEN and CLOSE with "Dead-man function" function
	7	Bistable function + Dead-man function	Same as function S01 - 3 OPEN and CLOSE with "Dead-man function" function
	8	Bistable function with automatic reclosing after pause time + Dead-man function	Same as function S01 - 4 OPEN and CLOSE with "Dead-man function" function
S 02	1	Reclosing when turning on (Standard value 0)	Complete open and close. ONLY when the tension has been interrupted when the gate is open.
S 04	1	It detects the passage (Standard value 0)	The access will be detected from the photo-beams, if S07 is 0 the pause time is 2sec.
S 07	1	It reverse in case of access (Standard value 1)	Put S04 in 1 . When the gate is opening, the control unit inverts the direction and close.
S 08	2	Logic of the Obstacle Detection (Standard value 2)	<ul style="list-style-type: none"> 1 - Function as limit switch 2 - Function as STOP 3 - Function as REVERSE and then STOP 4 - Automatic adjustment of motor torque, function L09 choose the right function according to the motor installed (not for sliding gates or safety devices).
T 18		Automatic opening after the time set	To set a time for your START-S12M to automatically start up , from 1 to 99 minutes. (00 If the function is deactivated). <u>Attention, choose a mode of operation with automatic reclosing.</u>

5.2 Working time

You can see how to program the control unit with **T** function:

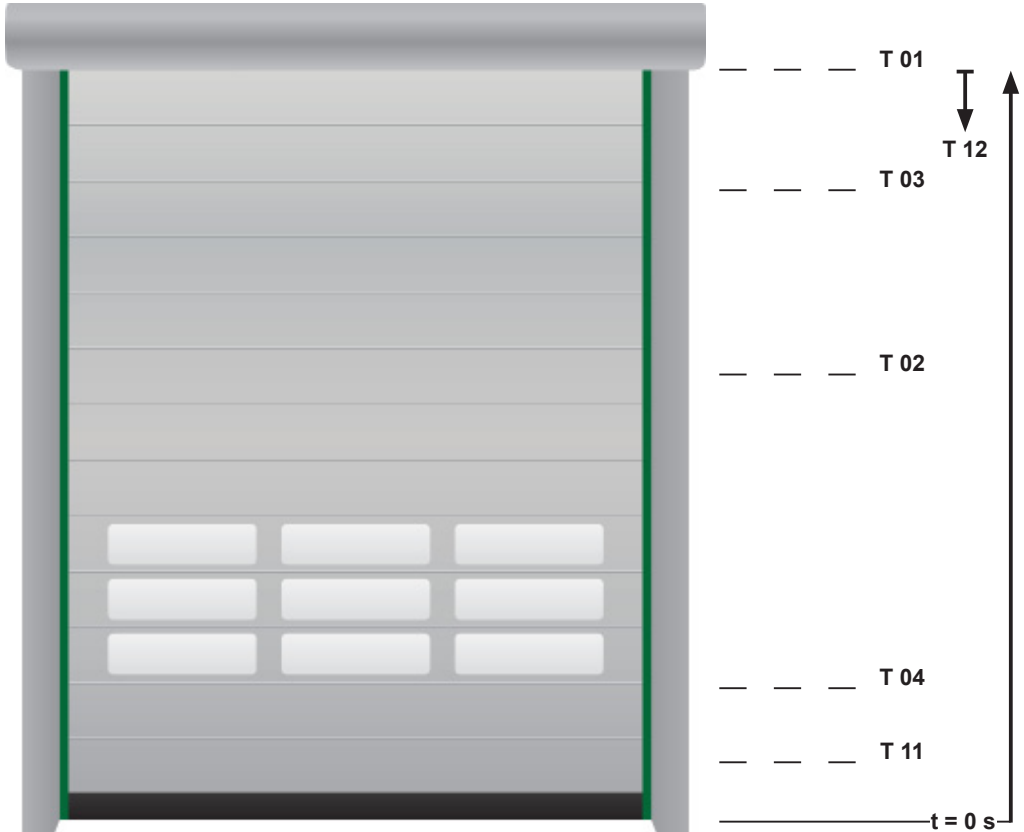

SET UP	DESCRIPTION		STANDARD - seconds -
T 01	Set up the fully opening time of the door/gate	value from 0,1 s	4,0
T 02	Set up the opening time of partial opening	value from 0,1 s	3,0
T 03	Set up the start position of OPEN decelerating time	value from 0,1 s	2,0
T 04	Set up START position of the CLOSING deceleration time	value from 0,1 s	1,0
T 11	Set up start position of deactivation of the photocelle. It is not considered if S03 is set in 1	value from 0,1 s	0,5
T 12	Deactivation Time of the input SAFETY EDGE (term.S16) from starting of LSO. <i>This function is useful in case of anti-folding to avoid the unroll of the curtain which can temporary cover the photocell and the door will start opening again.</i>		1,0

5.3 Set SPEED and ACCELERATION

Are now given the parameters that allow you to set SPEED, ACCELERATION and ABSORPTION:

Set up	Description	Values Accepted	Standard
L 01	Minimum speed OPENING	from 1 to 200	30
L 02	Minimum speed CLOSING	from 1 to 200	20
L 03	Maximum Speed OPENING	from 1 to 200	80
L 04	Maximum speed CLOSING	from 1 to 200	40
L 05	OPENING acceleration	from 1 to 99	8
L 06	CLOSING acceleration	from 1 to 99	8
L 07	OPENING deceleration	from 0 to 25	8
L 08	CLOSING deceleration	from 0 to 25	8
L 09	Motor absorption in case of STOP	Ampere	5,0
L 10	Motor absorption in case of problems	Ampere	7,0
L 11	Power in the BRAKE OUTPUT	from 1 to 70	50

5.4 SCHEME relation between SPEED and FREQUENCY of the motor

Here is the relation between speed and frequency of the motor:

SPEED SETTING	FREQUENCY [Hz]
1	12
5	14.50
10	17.00
15	19.50
20	22.00
25	24.50
30	27.00
35	29.50
40	32.00
45	34.50
50	37.00
55	39.50
60	42.00
65	44.50
70	47.50
75	49.50
80	52.00
85	54.50
90	57.00
95	59.50
100	62.00

SPEED SETTING	FREQUENCY [Hz]
105	64.50
110	67.00
115	69.50
120	72.00
125	74.50
130	77.00
135	79.50
140	82.00
145	84.50
150	87.00
155	89.50
160	92.00
165	94.50
170	97.00
175	99.50
180	102.00
185	104.50
190	107.00
195	109.50
200	112.00

6 INTERLOCK Function

WARNING: The TEST function and the PARTIAL OPENING are not available in this function!!!
 To activate the INTERLOCK function use function **S35** and connect the 2 control units.

CONTROL BOARD A

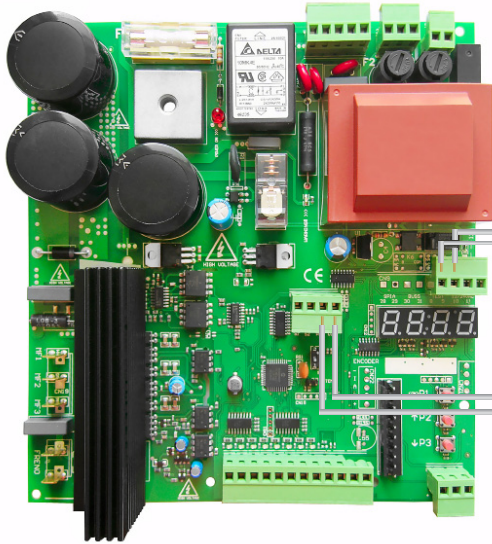

When one control unit is working, you can see in the display **FBUSS**, and it cannot accept other commands.



INTERLOCK FUNCTION
 1 - Activated
 0 - Deactivated

CONTROL BOARD B

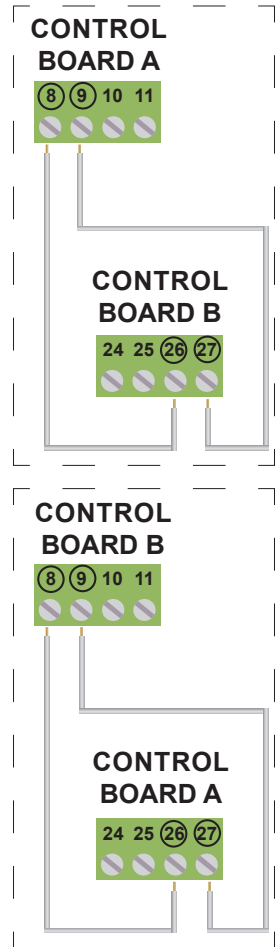
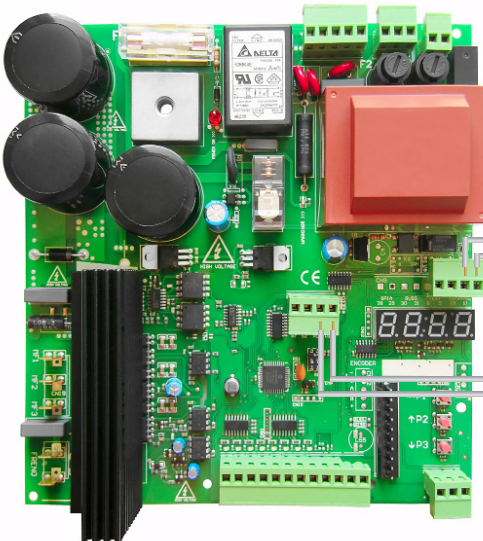

7 RESET of the control unit and restore of factory default settings

The control panel allows users to restore parameters to their standard values (see par. 8) also allows you set up the default factory settings of rapid doors (4.5 m - 3.5 m - 2.5 m) and sliding gates.

7.1 Restore factory settings

Checking those parameter of the parameters (Chapter no.8), you can look the set up during the RESET of the control unit. Select the paragraph S18 as shown.

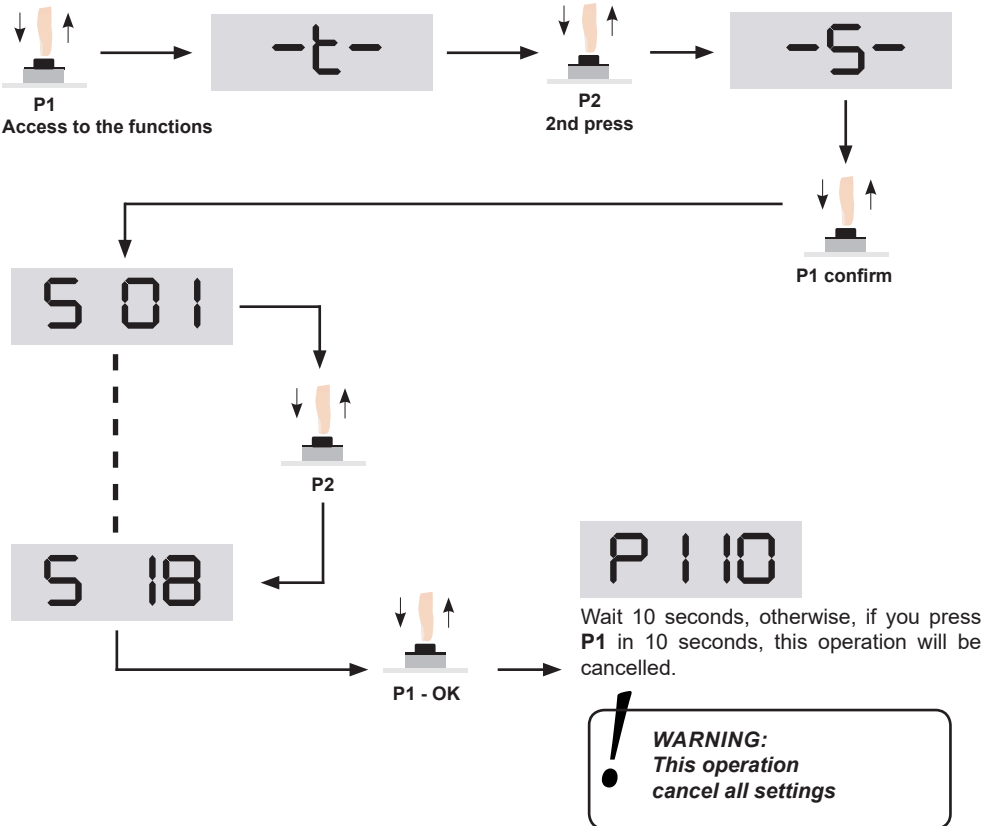

For standard values see table at pag no. 27 and following.

7.2 WARNING of the SETTING PARAMETERS

The first parameters are indicated for high speed doors, depending on the height of the door. The parameter no.4 is for industrial sliding gates.



Set up
STANDARD 1

P1



Set up
STANDARD 2

P1



Set up
STANDARD 3

P1

STANDARD 1	
Set up	Val.
T01	4,0
T02	3,0
T03	2,0
T04	1,0
T05	2,0
T06	5,0
T07	0,5
T08	2,0
T09	---
T10	5,0
T11	0,5
T12	1,0
T13	0,2
T14	0,1
T15	0,0
T16	0,0
T17	12

STANDARD 2 (High-speed doors h3,5m)	
Set up	Val.
T01	3,5
T02	2,5
T03	2,0
T04	1,0
T05	3,0
T06	3,0
T07	0,0
T08	0,0
T09	0,0
T10	4,5
T11	0,5
T12	0,0
T13	0,1
T14	0,1
T15	0,0
T16	0,0
T17	12

STANDARD 3 (High-speed doors h2,5m)	
Set up	Val.
T01	2,5
T02	2,0
T03	1,0
T04	0,5
T05	3,0
T06	3,0
T07	0,0
T08	0,0
T09	0,0
T10	3,5
T11	0,5
T12	0,0
T13	0,1
T14	0,1
T15	0,0
T16	0,0
T17	12

Set up	ST. 1	ST. 2-3
L01	15	20
L02	15	20
L03	80	80
L04	40	40

Set up	ST. 1	ST. 2-3
L05	10	8
L06	8	8
L07	20	8
L08	20	8

Set up	ST. 1	ST. 2-3
L09	8 [A]	11 [A]
L10	10 [A]	15 [A]
L11	50	50

Set up	ST. 1	ST. 2-3
S01	2	1
S03	1	0

Set up	ST. 1	ST. 2-3
S08	4	2
S22	0	1

Set up	ST. 1	ST. 2-3
S38	0	1



Set up
STANDARD 4

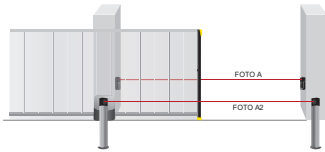

For sliding gates

STANDARD 4 (sliding gates)	
Set up	Val.
T01	20,0
T02	10,0
T03	17,0
T04	3,0
T05	10,0
T06	10,0
T07	2,0
T08	2,0
T09	120,0
T10	5,0
T11	0,0
T12	0,0
T13	1
T14	10
T15	0
T16	0

Set up	Val.
L01	30 (19 Hz)
L02	30 (19 Hz)
L03	80 (50 Hz)
L04	80 (50 Hz)
L05	4
L06	4
L07	4
L08	4
L09	3,0 [A]
L10	5,0 [A]
L11	70

7.3 SAVE SET UP and CHECK of the PARAMETERS

STARTS12 has 2 memory slots saving all manually set up and you can check it again. See how to check the set up with functions **S23**, **S24**, **S25**, **S26**. Once all parameters are set up, it is possible to change.

Thanks of the 2 memory slots, it is possible to save and check 2 differents set up.

• MEMORY 1 (slot 1)



• MEMORY 2 (slot 2)



8 LIST of the FUNCTIONS

Group functions "T"

SET UP	DESCRIPTION		VALUES ACCEPTED	STANDARD - seconds -	MEMO
T 01	Complete opening cycle time	step from 0,1 s		4,0	
T 02	Partial opening time	step from 0,1 s		3,0	
T 03	Set up deceleration by opening	step from 0,1 s		2,0	
T 04	Set up deceleration by closing	step from 0,1 s		1,0	
T 05	Pause time for START or OPEN	step from 0,5 s	from 2 to 127.5 s	2,0	
T 06	Pause time for PARTIAL OPENING	step from 0,5 s	from 2 to 127.5 s	5,0	
T 07	PRE-LIGHTING time by opening	step from 0,5 s	from 2 to 127 s	0,5	
T 08	PRE-LIGHTING time by closing	step from 0,5 s	from 2 to 127 s	2,0	
T 09	<i>(Not used)</i>				
T 10	Time to research of the limit switch	step from 0,1 s		5,0	
T 11	Stop the detection of input of the photo-beam. Not considered if S03 is set 1	step from 0,1 s		0,5	
T 12	<i>Time to stop to detecte the SAFETY EDEGE INPUT (terminal board. 16)</i>	step from 0,5 s		1,0	
T 13	Time block the check of the absorption of the motor when the gate is opening or closing	step from 0,1 s	from 0 to 2 s	0,2	
T 14	Pause time of reverse of the direction of the motor	step from 0,1 s	from 0 to 2 s	0,1	
T 15	STOP of the motor after detecting the LSO	step from 0,1 s	from 0 to 3 s	0 s	
T 16	Time of delay of the motor when detecting the LSC	step from 0,1 s	from 0 to 3 s	0 s	
T 17	Lead time on the release of the brake before starting the engine <i>(in tenths of seconds)</i>		from 0 to 20	12	
T 18	Automatic opening after the time set <i>(00 If the function is deactivated)</i>	step from 1 min	from 00 to 99 min	00	

Group functions "L"

SET UP	DESCRIPTION		VALUES ACCEPTED	STANDARD - seconds -	MEMO
L 01	Minimum opening speed		from 1 to 200	30	
L 02	Minimum closing speed		from 1 to 200	20	
L 03	Maximum opening speed		from 1 to 200	80	
L 04	Maximum closing speed		from 1 to 200	40	
L 05	Opening acceleration		from 1 a 99	8	
L 06	Closing acceleration		from 1 a 99	8	
L 07	Opening deceleration		from 0 to 25	8	
L 08	Closing deceleration		from 0 to 25	8	
L 09	Maximum absorption of the motor to STOP the door	in Ampere	from 0,5 to 15,5	5,0	
L 10	Maximum absorption of the motor in case of trouble	in Ampere	from 0,5 to 15,5	7,0	
L 11	Power of the output BRAKE		from 0 to 70	50	

Group functions “S”

SET UP	DESCRIPTION	VALUES ACCEPTED	STANDARD	MEMO
S 01	<p><i>Logic of the motor:</i></p> <p>1 - Fast reverse 2 - Collective use 3 - Bistable function 4 - Bistable function with automatic reclosing 5 - Fast reversing and “Dead’s man” function 6 - Collective use and “Dead’s man” function 7 - Bistable function and “Dead’s man” function 8 - Bistable function with automatic reclosing and “Dead’s man” function</p>	from 1 to 8	1	
S 02	Opening-closing cycle when the door is not closed	0 Off - 1 On	0	
S 03	Deactivate the input PHOTO A after intervention of the slow down LSC	0 Deactivated - 1 Activated	0	
S 04	Passage Detection	0 Off - 1 On	0	
S 05	Signal light in pause time	0 Off - 1 On	0	
S 06	Activation TEST in the safeties inputs	0 Off - 1 On	0	
S 07	Logic passage detection	0 Off - 1 On	0	
S 08	Logic of the Obstacle Detection	1 - Considered as LIMIT SWITCH 2 - Considered as STOP 3 - Reverse motor of 2 sec, at min. speed 4 - According to the set up of function L09 and according to the motor (<i>not for sliding gates of safety devices</i>)	2	
S 09	Activate the TEST in the input PHOTOCELL	0 Off - 1 On	0	
S 10	Activate the TEST in the SAFETY EDGE input	0 Off - 1 On	0	
S 11	Activate the TEST in the input STOP	0 Off - 1 On	0	
S 12	Activate the flashing in the signal light input	0 Off - 1 On	1	
S 13	Activate the input LSO	0 Off - 1 On	1	
S 14	Activate the input LSC	0 Off - 1 On	1	
S 15	Activate STOP input	0 Off - 1 On	1	
S 16	Activate the PHOTOCELL by closing	0 Off - 1 On	1	
S 17	Activate the input ANTIFOLDING	0 Off - 1 On	1	
S 18	Reset of the control unit at factory’s settings			
S 19	Polarity of the brake output	0 - deactivated with tension 1 - brake activated with tension	0	
S 20	Activated the input SWITCH for opening slowing down	0 Off - 1 On	1	
S 21	Activate the input switch for CLOSING slowing down	0 Off - 1 On	1	
S 22	Activate the input for SAFETY EDGE (terminal 20-21)	0 Deactivated - 1 Activated	1	

SET UP	DESCRIPTION	VALUES ACCEPTED	STANDARD	MEMO
S 23	Copy set up of memory 1			
S 24	Copy set up of memory 2			
S 25	Charge the set up of memory 1			
S 26	Charge the set up of memory 2			
S 27	Charge the standard set up 1			
S 28	Charge the standard set up 2			
S 29	Charge the standard set up 3			
S 30	Charge the standard set up 4			
S 31	Charge the standard set up 5			
S 32	Activate of a password to set up with a code of 4 numbers. Put the new code and let the time goes.			
S 33	You can deactivate the access of the set up with a password			
S 34	Activation of the security closing after intervention of the edge (20-21)	0 deactivated - 1 activated	0	
S 35	Activation of the INTERLOCK function	0 deactivated - 1 activated	0	
S 36	Check of the input UNFOLDING (terminal board no.16)	0 deactivated - 1 activated	0	
S 37	Integrated electric brake (activated for 2 seconds after motor stopping)	1= light acceleration 4 = heavy acceleration 5=neither acceleration nor braking 6= light braking 9= heavy braking	0	
S 38	Safety edge - contact terminal board no.20-21	0: N.C. contact - 1: 8K2 contact	1	
S 39	Opening / Closing in case of emergency	0 deactivated - 1 activated	0	

Group functions "R"

SET UP	DESCRIPTION
R 01	Activate Opening until P1 has been released with acceleration set up
R 02	Activate CLOSING until P1 has been released with acceleration set up
R 03	Activate the OPENING until P1 has been released with slow down acceleration
R 04	Activate CLOSING until P1 has been released with slow down set up
R 05	Activate LIGHT/SIGNAL LIGHTH until P1 has been released
R 06	Activate TEST output until P1 has been released
R 07	Display the tension of the capacitors until P1 has been released
R 08	Display temperature of the IGBT until P1 has been released
R 09	Display the resistive value in the SAFETY EDGE input (terminal board no.20) until P1 has been released
R 10	Display the number of cycles number of cycles until P1 has been released (<i>point indicated the thousands</i>)
R 11	Activate the brake output

9 Problems

Here are listed some functions issue indicated in the display. You can see the causes and the procedure to solve the issue.

Problem	Description	Solution
Er01	OVERVOLT on vbus	There is a tension of 240 Vac in the capacitors. <i>Check the network tension.</i>
Er02	OVERCURRENT in the MOTOR	The overcurrent level of programm L10 has been exceeded. <i>If necessary increase the value.</i>
Er03	Tension in the capacitors too low	The tension in the capacitors is too low. <i>Check the network tension.</i>
Er04	Absorption at 1.5 A when the motor is not working	The control unit has an absorption of more than 1,5A even if the motor is not working. <i>Check the accessories and the motor.</i>
Er05	Security code not correct	Code not correct. <i>Try a new code.</i>
Er06	Exceeded temperature of the spendthrift IGBT	<i>Wait until the temperature in the spendthrift is reduced.</i>
Er07 Er17 Er27 Er67 Er77	Signal error of the encoder	Check the encoder connections
Er57	The barriers doesn't detect the cycle of the door when the motor is powering.	Check the curtains

11 Declaration of CE conformity

(according to EC Directive 2006/42, Attachment II, part 1, ses. A)

The undersigned **Ernestino Bandera**,
Administrator

DECLARES THAT:



Company: EB TECHNOLOGY SRL
Address: Corso Sempione 172/5
 21052 Busto Arsizio VA Italy
Product's name: START-S12-M
 Centrale Inverter 230Vac

THE PRODUCT COMPLIES with what is outlined in the European Community directive:

2006/42/CE	EC DIRECTIVE 2006/42 ISSUED BY THE EUROPEAN PARLIAMENT AND COUNCIL on may 17, 2006 harmonizing the legislation of the member countries regarding machinery.
-------------------	---

Reference: Attachment II, part 1, ses. A (EC Declaration of Conformity issued by the manufacturer).

THE PRODUCT COMPLIES with what is outlined in the European Community directives:

2014/35/CE	DIRECTIVE 2014/35/EU OF THE EUROPEAN PARLIAMENT AND OF THE COUNCIL of 26 February 2014 on the harmonisation of the laws of the Member States relating to the making available on the market of electrical equipment designed for use within certain voltage limits.
-------------------	---

Reference to harmonized standards: EN 60335-1

2014/30/CE	DIRECTIVE 2014/30/EU OF THE EUROPEAN PARLIAMENT AND OF THE COUNCIL of 26 February 2014 on the harmonisation of the laws of the Member States relating to electromagnetic compatibility.
-------------------	---

Reference to harmonized standards: EN 61000-6-2 EN 61000-6-3

IL PRODOTTO E' CONFORME with the essential requirements of article 3 of the following European Community Directive, for the use for which the product is designede

2014/53/CE (RED)	DIRECTIVE 2014/53/EU OF THE EUROPEAN PARLIAMENT AND OF THE COUNCIL of 16 April 2014 on the harmonisation of the laws of the Member States relating to the making available on the market of radio equipment
-------------------------	---

Reference to harmonized standards: ETSI EN 300 220-3 ETSI EN 301 489-1 ETSI EN 301 489-3

The directive 2006/42/CE remind that it is not allowed the function of the product until the machine, for which the product is included, is not indentify and declared conformed to the 2006/42/CE directive.

EB TECHNOLOGY S.r.l.
 Corso Sempione 172/5,
 21052 Busto Arsizio VA Italy

NOLOGO S.r.l.
 via Cesare Cantù 26,
 20020 Villa Cortese MI Italy
 tel. +39 0331.430457
 fax.+39 0331.432496

Dairago, 01/06/2017
 The Administrator
 Ernestino Bandera

posta@ebtechnology.it
 www.ebtechnology.it

info@nologo.info
 www.nologo.info



<p>DICHIARAZIONE DI CONFORMITA'</p> <p>Il sottoscritto, rappresentante il seguente costruttore, dichiara che l'apparecchio denominato</p> <p style="text-align: center;">START-S12-M</p> <p>risulta conforme a tutte le norme tecniche relative al prodotto entro il campo di applicabilità delle Direttive Comunitarie 2006/42/CE, 2014/35/CE, 2014/30/CE e 2014/53/CE</p> <p>Sono state eseguite tutte le necessarie prove di radiofrequenza</p> <p style="text-align: center;">EB TECHNOLOGY SRL Corso Sempione 172/5 21052 Busto Arsizio (Va) Italia</p> <p>Questa dichiarazione viene emessa sotto la sola responsabilità del costruttore e, se applicabile, del suo rappresentante autorizzato.</p> <p>Italia, 01/06/2017</p> <p style="text-align: center;">Amministratore</p>	<p>DECLARATION OF CONFORMITY</p> <p>The undersigned, representative of the following manufacturer, hereby certifies that the equipment known as</p> <p style="text-align: center;">START-S12-M</p> <p>complies with all technical requirements concerning this product within the domain of application of the EC Directives 2006/42/CE, 2014/35/CE, 2014/30/CE and 2014/53/CE</p> <p>All necessary radiofrequency tests have been performed</p> <p style="text-align: center;">EB TECHNOLOGY SRL Corso Sempione 172/5 21052 Busto Arsizio (Va) Italia</p> <p>This declaration is rendered under the manufacturer's sole responsibility, and if applicable, under responsibility of his authorized representative.</p> <p>Italia, 01/06/2017</p> <p style="text-align: center;">Administrator</p>	<p>DÉCLARATION DE CONFORMITÉ</p> <p>Le soussigné, représentant du constructeur suivant certifie que les appareils ci-dessus référencés</p> <p style="text-align: center;">START-S12-M</p> <p>sont conformes à toutes les normes techniques relativement au produit dans le domaine d'application des Directives Européennes 2006/42/CE, 2014/35/CE, 2014/30/CE et 2014/53/CE</p> <p>Toutes les essais de radiofréquence nécessaires ont été effectués</p> <p style="text-align: center;">EB TECHNOLOGY SRL Corso Sempione 172/5 21052 Busto Arsizio (Va) Italia</p> <p>Cette déclaration est présentée sous la seule responsabilité du constructeur et, si applicable, de son représentant autorisé.</p> <p>Italia, 01/06/2017</p> <p style="text-align: center;">Administrateur</p>
<p>KONFORMITÄTZERTIFIKAT</p> <p>Der Unterzeichner bescheinigt, dass das Produkt</p> <p style="text-align: center;">START-S12-M</p> <p>allen technischen Produktegesetzen, laut den Europäische Gesetzen 2006/42/CE, 2014/35/CE, 2014/30/CE e 2014/53/CE, entspricht.</p> <p>Alle Radiofrequenzprüfungen haben bei der nachstehenden Firma stattgefunden:</p> <p style="text-align: center;">EB TECHNOLOGY SRL Corso Sempione 172/5 21052 Busto Arsizio (Va) Italia</p> <p>Diese Bescheinigung wird unter der alleinigen Verantwortung des Herstellers ausgestellt und dort waoanwenbar, auch unter der des befugten Vertreters.</p> <p>Italia, 01/06/2017</p> <p style="text-align: center;">Verwalter</p>	<p>DECLARACIÓN DE CONFORMIDAD</p> <p>El abajo firmante, representante el fabricante siguiente, declara que el equipo denominado</p> <p style="text-align: center;">START-S12-M</p> <p>es conforme con todas las normas técnicas correspondientes al producto en el campo de aplicación de las Directivas Comunitarias 2006/42/CE, 2014/35/CE, 2014/30/CE y 2014/53/CE</p> <p>Han sido realizadas todas las necesarias pruebas de radiofrecuencia.</p> <p style="text-align: center;">EB TECHNOLOGY SRL Corso Sempione 172/5 21052 Busto Arsizio (Va) Italia</p> <p>Esta declaración se expide bajo la exclusiva responsabilidad del fabricante y, si de aplicación, de su representante autorizado.</p> <p>Italia, 01/06/2017</p> <p style="text-align: center;">Administrador</p>	<p>DECLARAÇÃO DE CONFORMIDADE</p> <p>O abaixo-assinado, representando o seguinte construtor declara que o aparelho denominado</p> <p style="text-align: center;">START-S12-M</p> <p>é conforme a todas as normas técnicas relativas ao produto dentro o campo de aplicabilidade das Diretivas Comunitarias 2006/42/CE, 2014/35/CE, 2014/30/CE e 2014/53/CE</p> <p>Foram executadas todas as necessárias provas de rádio frequência.</p> <p style="text-align: center;">EB TECHNOLOGY SRL Corso Sempione 172/5 21052 Busto Arsizio (Va) Italia</p> <p>Esta declaração vem emitida somente com a responsabilidade do construtor e, se aplicável, do seu representante autorizado.</p> <p>Italia, 01/06/2017</p> <p style="text-align: center;">Administrador</p>