

Modbus Server

Digitally Addressable Lighting Interface (DALI-2)



USER MANUAL

Issue date: 01/2022 r1.3 ENGLISH

Important User Information

Disclaimer

The information in this document is for informational purposes only. Please inform HMS Industrial Networks of any inaccuracies or omissions found in this document. HMS Industrial Networks disclaims any responsibility or liability for any errors that may appear in this document.

HMS Industrial Networks reserves the right to modify its products in line with its policy of continuous product development. The information in this document shall therefore not be construed as a commitment on the part of HMS Industrial Networks and is subject to change without notice. HMS Industrial Networks makes no commitment to update or keep current the information in this document.

The data, examples and illustrations found in this document are included for illustrative purposes and are only intended to help improve understanding of the functionality and handling of the product. In view of the wide range of possible applications of the product, and because of the many variables and requirements associated with any particular implementation, HMS Industrial Networks cannot assume responsibility or liability for actual use based on the data, examples or illustrations included in this document nor for any damages incurred during installation of the product. Those responsible for the use of the product must acquire sufficient knowledge in order to ensure that the product is used correctly in their specific application and that the application meets all performance and safety requirements including any applicable laws, regulations, codes and standards. Further, HMS Industrial Networks will under no circumstances assume liability or responsibility for any problems that may arise as a result from the use of undocumented features or functional side effects found outside the documented scope of the product. The effects caused by any direct or indirect use of such aspects of the product are undefined and may include e.g. compatibility issues and stability issues.

Gateway for integration of DALI devices into Modbus (RTU and TCP) systems.

ORDER CODE
INMBSDAL0640200
INMBSDAL1280200

INDEX

- 1 Description 6
 - 1.1 Introduction 6
 - 1.2 Functionality 8
 - 1.3 Gateway’s capacity 8
- 2 DALI Interface 9
 - 2.1 Characteristics 9
- 3 Modbus interface 10
 - 3.1 Functions supported 10
 - 3.2 Modbus RTU 10
 - 3.3 Modbus TCP 10
 - 3.4 Modbus Address Map 11
 - 3.4.1 Single DALI device signals 11
 - 3.4.2 DALI groups’ signals 19
 - 3.4.3 Broadcast signals 21
 - 3.4.4 Input Devices 25
- 4 Connections 26
 - 4.1 Powering the device 28
 - 4.2 Connection to DALI channel 28
 - 4.3 Connection to Modbus 29
 - 4.3.1 Modbus TCP 29
 - 4.3.2 Modbus RTU 29
 - 4.4 Connection to PC (Configuration tool) 29
- 5 Status LEDs and push buttons 30
- 6 Set-up process and troubleshooting 31
 - 6.1 Pre-requisites 31
 - 6.2 Intesis MAPS. Configuration & monitoring tool for Intesis 31
 - 6.2.1 Introduction 31
 - 6.2.2 Connection 31
 - 6.2.3 Configuration tab 32
 - 6.2.4 Signals 33
 - 6.2.5 Sending the configuration to Intesis 33
 - 6.2.6 Diagnostic 34
 - 6.3 Set-up procedure 35
- 7 Electrical & Mechanical Features 37
- 8 Dimensions 38
- Annex A – Quick setup and commissioning of a DALI network 39
 - 1 Create project 40

2	Device declaration in project.....	40
3	Scan and commissioning of devices.....	43
4	Input device programming options.....	48
4.1	Instance´s Event programming (action from the BMS)	49
4.1.1	Set the update method on the DALI bus	49
4.1.2	Set the Input device properties	49
4.2	Input device Local management (DALI local control).....	51
4.3	Multi editing options.....	53

1 Description

1.1 Introduction

This document describes the integration of DALI-2 lighting ballasts and sensors into Modbus compatible devices and systems using the Intesis Modbus Server to DALI-2 communication gateway.

The aim of this integration is to monitor and control DALI-2 lighting ballasts and sensors (see section 2 for specific DALI parts), remotely, from your Control Center using any commercial SCADA or monitoring software that includes a Modbus Master driver (RTU and/or TCP). To do it so, Intesis performs as a Modbus Server, allowing poll and write requests from any Modbus master device.

For Push buttons and Absolute input devices there is an option to have a direct control of the ECGs from the gateway itself called Input device local management, so you can create an action associated to an event of the Push Button and Absolute input devices, this can be a more effective way to achieve a reaction on the lights. You have also the option on controlling the ECG action from the BMS in cases where you are controlling other items together with the light.

Up to 64 addresses for DALI lighting devices (ECGs), and another 64 addresses for Sensors can be fitted in a single DALI channel, and therefore controlled and monitored from Intesis gateway. Depending on the version of the gateway, 1 line (64 addresses for ECG and 64 addresses for Sensors) or 2 lines (128 addresses for ECG and 128 addresses for Sensors) are supported.

Version supporting 2 DALI channels does not have support for Modbus RTU – it’s a Modbus TCP-only device.

Intesis needs to be configured using Intesis MAPS software configuration tool. In the software, Modbus and DALI lighting device parameters must be configured and downloaded to the Intesis gateway.

This document assumes the user is familiar with Modbus and DALI technologies and technical terms.



NOTE: Intesis is compatible with Ballasts and sensors implementing the DALI-2 standard and certified under the DiiA guidelines for testing and certification. Use only DALI-2 devices having the DALI-2 logo with Intesis.

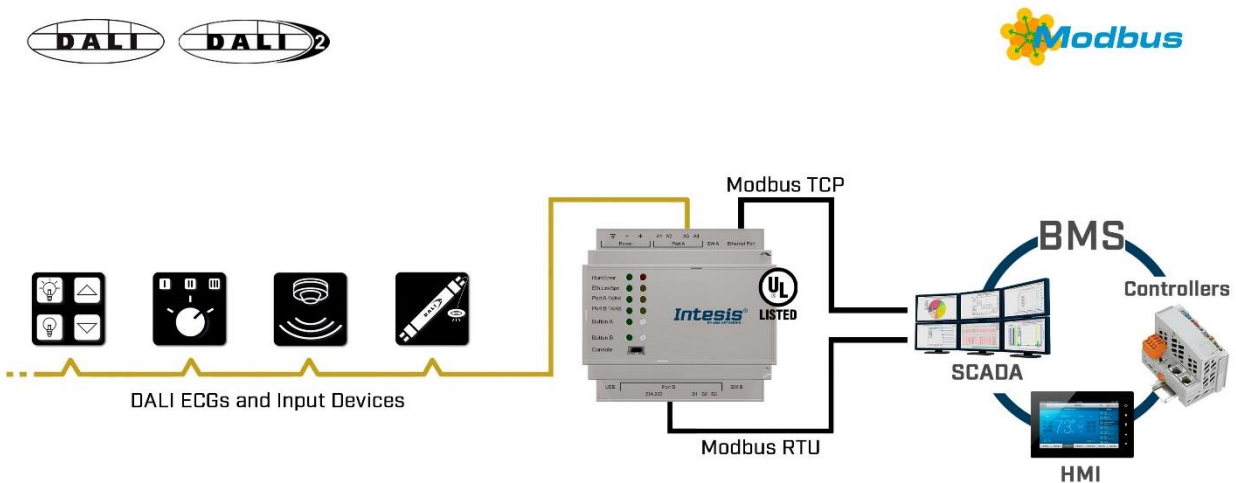

Integration of DALI into Modbus TCP / Modbus RTU control systems (product version supporting 1 DALI channel)

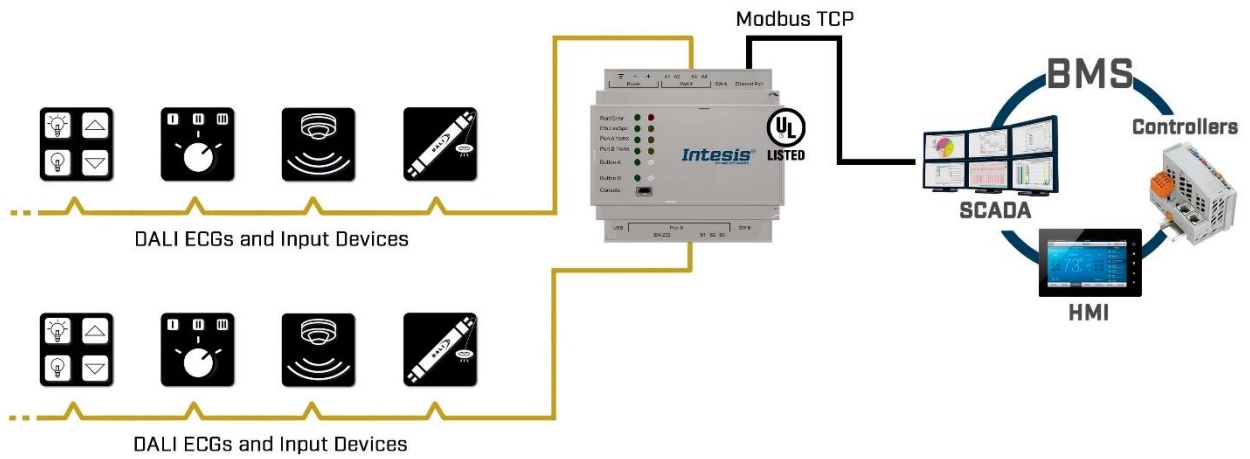
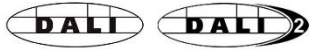

Integration of DALI into Modbus TCP control systems (product version supporting 2 DALI channels)

1.2 Functionality

Intesis® continuously polls (reads) all the signals of the DALI ECGs and sensors in each line and maintains the updated values to be served in Modbus.

When a write is done from Modbus in a gateway's Modbus writeable address, the corresponding command is sent to the corresponding DALI device.

In the continuous polling process of the DALI channel, if there is no answer, it is indicated with a virtual signal of communication error for this device in its line.

The IP address and communication parameters for Modbus side of the gateway (TCP or RTU) must be set in the MAPS configuration tool.

From the configuration tool, it is also possible to scan each DALI channel for available ECGs and/or sensors, add them in configuration, and configure its individual parameters (short address, preset levels, scenes, etc), according to their device type or instance.

1.3 Gateway's capacity

Intesis capacity is listed below:

Element	Max.	Notes
Number of DALI channels	2	Number of independent DALI channels
Number DALI ECGs addresses per line	64	64 DALI ECGs addresses are supported per line
Number DALI Input devices addresses per line	64*	64 DALI Input devices addresses are supported per line <small>The maximum number of devices is limited by the guaranteed power supply of the DALI network and max signals. Keep in mind when dimensioning each DALI channel. See Section 2 for more details.</small>
Max number of Modbus variables per DALI device	61	Number of available signals will vary according to device type
Max number of Modbus variables per DALI group	16	Number of available signals will vary according to device type
Number of incoming sockets at Modbus TCP side	5	5 simultaneous TCP sockets are supported
Maximum number of signals per gateway	10000	Can enable up to 10000 signals for the entire gateway regardless if they are ECG, Input devices, Groups or Broadcast

*16 would be recommended specially if using push buttons, have in mind that this would be limited for the maximum number of signals allowed, devices as the push buttons with several instances would consume several signals and input devices consume more power than ECGs, See Section 2 for more details.

There are 2 different models of *Intesis® Modbus Server – DALI* with different capacity. The table above shows the capacity for the top model (with maximum capacity).

The 2 different models allow integrating respectively: 1 or 2 DALI channels.

Their **order codes** are:

- **INMBSDAL0640200.** Model supporting 1 DALI channel (up to 64 DALI ECGs and 64 DALI sensors)
- **INMBSDAL1280200.** Model supporting 2 DALI channels (up to 64 DALI ECGs and 64 DALI sensors per channel)

2 DALI Interface

Intesis gateway and its DALI interface complies with the new DALI-2 (IEC62386) standard thanks to its DALI-2 certification.

Intesis gateway enables the connection of up to 64 DALI/DALI-2 ECGs and 64 DALI-2 sensors. In current version of the device, the following device types are supported:

- General requirements (Part 101)
 - Part 201: DALI Fluorescent lamps (DALI type 0)
 - Part 202: Self-contained Emergency lighting (DALI type 1)
 - Part 207: LED modules (DALI type 6)
 - Others (Multiple DALI types)
- Sensors (Part 103):
 - Part 301: DALI-2 Push buttons
 - Part 302: DALI-2 Absolute input devices
 - Part 303: DALI-2 Occupancy sensors
 - Part 304: DALI-2 Light sensors

The maximum number of DALI devices (ECGs and/or input devices) depends on the sum current consumption of the specific devices. Intesis gateway supplies bus power of 235 mA for power supply of the DALI devices, so if all input devices (sensors) in the bus consumed 5 mA then we could connect 64 ECGs (standard defines max. consumption allowed for these devices is 2mA) and 16 sensors.

$$64 \text{ ECGs} * 2 \text{ mA} + 16 \text{ sensors} * 5 \text{ mA} = 208 \text{ mA} < 235 \text{ mA} * 90\%$$

As the standard recommends, don't use the guaranteed current to calculate the maximum number of DALI devices, leave 10% of the current for dynamic processes into account.

2.1 Characteristics

Element	Values
DALI voltage (V)	14 V – 17 V; typically, 16V
Guaranteed current (mA) available per line	235
Maximum Current (mA) available per line	250
Start-up time (ms)	1500
Shutdown time (sec)	7
Data transfer rate (bauds)	1200

3 Modbus interface

3.1 Functions supported

This part is common for Modbus RTU and TCP.

Modbus functions 03 and 04 (*Read Holding Registers* and *Read Input Registers*) can be used to read Modbus registers.

Modbus functions 06 and 16 (*Single Multiple Holding Registers* and *Write Multiple Holding Registers*) can be used to write Modbus registers.

Configuration of poll records is possible between Modbus addresses 0 and 20000. Addresses that are not defined in section 2.4 (Modbus map of the device) are read-only and will always report 0.

Modbus error codes are supported, they will be sent whenever a non-valid Modbus address is queried.

All registers are 16-bit signed integer, in standard Modbus Big Endian (MSB/LSB) format.

Intesis supports Modbus RTU and Modbus TCP and both interfaces can be used simultaneously.

3.2 Modbus RTU

Modbus RTU is only available in version of the product supporting 1 DALI channel. Product version supporting 2 DALI channels provides support for Modbus TCP only.

When present, both EIA485 and EIA232 physical layers are supported. Only the lines RX, TX and GND of the EIA232 connector are used (TX and RX for EIA485).

Baud rate can be selected between 1200, 2400, 4800, 9600, 19200, 38400, 56700 and 115200. Parity (none, even or odd) and stop bits (1 or 2) can be selected as well.

Modbus slave number must be configured and the physical connection (RS232 or RS485) can also be selected.

3.3 Modbus TCP

TCP port to use (default is 502) and keep alive period must be configured.

IP settings of Intesis (DHCP status, own IP, net mask and default gateway) must be configured as well.

3.4 Modbus Address Map

Note that this map only applies when **Modbus Addresses** parameter is set to **Fixed**. For more information about configuration of Modbus Addresses parameter see Intesis MAPS Modbus Server User Manual.

3.4.1 Single DALI device signals

There are up to 94 signals for each DALI device. Their Modbus addresses can be obtained applying the following formula:

$$\text{Modbus Address} = 7000 \times \text{CHANNEL} + (100 \times \text{ECG}) + \text{SIGNAL NUMBER}$$

Where:

- CHANNEL NUMBER: 0..1 (always 0 if using version with support for 1 DALI channel)
- BALLAST NUMBER: 0..63 (ballast short address)
- SIGNAL NUMBER: 0..93, see following table

Modbus address from the formula is expressed in link layer format. This is, first register address is 0.

Supported signals vary according to device type. Following abbreviations are done in the table:

- FL: Fluorescent light (device type 0)
- EML: Emergency light (device type 1)
- LED: LED module (device type 6)
- Other.

Modbus Address <small>First Address is 0</small>	ECG type			Read/Write	Register/signal name	Possible values
	FL	EML	LED			
7000 x channel + (100 x sa) + 0 <small>channel stands for DALI channel and is 0 or 1 sa stands for short address and is 0 to 63</small>	x	x	x	R	Ballast / Lamp Failure bit fields (ECG15-ECG0)	0-OK, 1-Ballast / Lamp Failure $b_i [i = sa - (16 * (\text{line}-1))]$
7000 x channel + (100 x sa) + 1	x	x	x	R	Ballast / Lamp Failure bit fields (ECG31-ECG16)	0-OK, 1-Ballast / Lamp Failure $b_i [i = sa - (16 * (\text{line}-1))]$
7000 x channel + (100 x sa) + 2	x	x	x	R	Ballast / Lamp Failure bit fields (ECG47-ECG32)	0-OK, 1-Ballast / Lamp Failure $b_i [i = sa - (16 * (\text{line}-1))]$

Modbus Address <small>First Address is 0</small>	ECG type			Read/ Write	Register/signal name	Possible values
	FL	EML	LED			
7000 x channel + (100 x sa) + 3	x	x	x	R	Ballast / Lamp Failure bit fields (ECG63-ECG48)	0-OK, 1-Ballast / Lamp Failure $b_i [i = sa - (16 * (line-1))]$
7000 x channel + (100 x sa) + 4	x	x	x	R/W	Update All ECG Status	0-Update Finished, 1-Trigger Update
7000 x channel + (100 x sa) + 5	x	x	x	R	Ballast Status	b7-PwrCycle, b6-MissShAdd, b5-ResetSt, b4-FadeRun, b3-BallLimErr, b2-LampPwrOn, b1-LampFail, b0-BallFail
7000 x channel + (100 x sa) + 6	x	x	x	R	Actual Level	0 to 100 %
7000 x channel + (100 x sa) + 7	x	x	x	R	Device Type	0-Fluorescent, 1-Emergency, 2 Discharge, 3-Halogen, 4- Incandescent, 5-Digital signal, 6-LED, 7-Switching, 8- Colour Control
7000 x channel + (100 x sa) + 8	x	x	x	R	Physical Minimum Level	0 to 100 %
7000 x channel + (100 x sa) + 9	x	x	x	R	Min Level	0 to 100 %
7000 x channel + (100 x sa) + 10	x	x	x	R	Max Level	0 to 100 %
7000 x channel + (100 x sa) + 11	x	x	x	R	Power On Level	0 to 100 %
7000 x channel + (100 x sa) + 12	x	x	x	R	System Failure Level	0 to 100 %
7000 x channel + (100 x sa) + 13	x	x	x	R	Fade Time	0 to 15
7000 x channel + (100 x sa) + 14	x	x	x	R	Fade Rate	1 to 15
7000 x channel + (100 x sa) + 15	x	x	x	R/W	Arc Power Level	0 to 100 %

Modbus Address <small>First Address is 0</small>	ECG type			Read/ Write	Register/signal name	Possible values
	FL	EML	LED			
7000 x channel + (100 x sa) + 16	x	x	x	R/W	Arc Power Off / On	0-Off; 1-100 %
7000 x channel + (100 x sa) + 17	x	x	x	R/W	Step Down / Up	0-Step Down, 1-Step Up
7000 x channel + (100 x sa) + 18	x	x	x	W (trigger)	Recall Min Level	1-Recall Min Level
7000 x channel + (100 x sa) + 19	x	x	x	W (trigger)	Recall Max Level	1-Recall Max Level
7000 x channel + (100 x sa) + 20	x	x	x	R/W	Go to Scene	0 to 15
7000 x channel + (100 x sa) + 21	x	x	x	R/W	Store Current Level as Scene	0 to 15
7000 x channel + (100 x sa) + 22	x	x	x	R/W	Clear/Remove Scene	0 to 15
7000 x channel + (100 x sa) + 23	x	x	x	R/W	Set Fade Time	0 to 15
7000 x channel + (100 x sa) + 24	x	x	x	R/W	Set Fade Rate	1 to 15
7000 x channel + (100 x sa) + 25	x	x	x	R/W	Set Min Level	0 to 100 %
7000 x channel + (100 x sa) + 26	x	x	x	R/W	Set Max Level	0 to 100 %
7000 x channel + (100 x sa) + 27	x	x	x	R/W	Set Power-on Level	0 to 100 %
7000 x channel + (100 x sa) + 28	x	x	x	R/W	Set System-failure Level	0 to 100 %

Modbus Address <small>First Address is 0</small>	ECG type			Read/ Write	Register/signal name	Possible values
	FL	EML	LED			
7000 x channel + (100 x sa) + 29				R	Not used	Default to 0
7000 x channel + (100 x sa) + 30				R	Not used	Default to 0
7000 x channel + (100 x sa) + 31				R	Multicontrol	0-Off, 1-100%, 2-StpUp, 3-StpDwn, 1XX-GoScn, 2XX-StoreScn, 3XX-RmvScn, 1XXX-FdRate, 2XXX-FdTime, 3XXX-MinLvl, 4XXX-MaxLvl, 5XXX-PwrOnLvl, 6XXX-SysFailLvl
7000 x channel + (100 x sa) + 32				R	Not used	Default to 0
7000 x channel + (100 x sa) + 33				R	Not used	Default to 0
7000 x channel + (100 x sa) + 34				R	Not used	Default to 0
7000 x channel + (100 x sa) + 35	x			R/W	Set System-failure Level	0 to 100 %
7000 x channel + (100 x sa) + 36				R	Not used	Default to 0
7000 x channel + (100 x sa) + 37				R	Not used	Default to 0
7000 x channel + (100 x sa) + 38				R	Not used	Default to 0
7000 x channel + (100 x sa) + 39				R	Not used	Default to 0
7000 x channel + (100 x sa) + 40				R	Not used	Default to 0
7000 x channel + (100 x sa) + 41				R	Not used	Default to 0

Modbus Address <small>First Address is 0</small>	ECG type			Read/ Write	Register/signal name	Possible values
	FL	EML	LED			
7000 x channel + (100 x sa) + 42		x		R	Failure Status	b7-FunctFail, b6-DurFail, b5-DurTestDelay, b4-FunctTestDelay, b3-EmLampFail, b2-BattFail, b1-BattDurFail, b0-CircFail
7000 x channel + (100 x sa) + 43		x		R	Emergency Mode	b7-HardSwOn, b6-HardInhibit, b5-DurTestProg, b4-FunctTestProg, b3-ExtdEmMode, b2-EmMode, b1-NormMode, b0-RestMode
7000 x channel + (100 x sa) + 44		x		R	Emergency Status	b7-PhysicSel, b6-Ident, b5-DurTestPend, b4-FunctTestPend, b3-BattFull, b2-DurTestDone, b1-FunctTestDone, b0-InhibitMode
7000 x channel + (100 x sa) + 45		x		R	Emergency Battery Charge	0 to 100 %
7000 x channel + (100 x sa) + 46		x		R	Next Function Test	0 to 16384 hours
7000 x channel + (100 x sa) + 47		x		R	Next Duration Test	0 to 16384 hours
7000 x channel + (100 x sa) + 48		x		R	Function Test Interval	0-Disabled, 1 to 255 days
7000 x channel + (100 x sa) + 49		x		R	Duration Test Interval	0-Disabled, 1 to 97 weeks
7000 x channel + (100 x sa) + 50		x		R	Test Execution Timeout	0 to 255 days
7000 x channel + (100 x sa) + 51		x		R	Prolong Time	0 to 127,5 minutes
7000 x channel + (100 x sa) + 52		x		R	Duration Test Result	0 to 510 minutes
7000 x channel + (100 x sa) + 53		x		R	Lamp Total Operation Time	0 to 1016 hours
7000 x channel + (100 x sa) + 54		x		R	Emergency Level	0 to 100 %

Modbus Address <small>First Address is 0</small>	ECG type			Read/ Write	Register/signal name	Possible values
	FL	EML	LED			
7000 x channel + (100 x sa) + 55		x		R	Emergency Min Level	0 to 100 %
7000 x channel + (100 x sa) + 56		x		R	Emergency Max Level	0 to 100 %
7000 x channel + (100 x sa) + 57		x		R	Rated Duration	0 to 510 minutes
7000 x channel + (100 x sa) + 58		x		R	Features	b7-RelightRestSup, b6-PhysicSelSup, b5-HardInSup, b4-AdjsEmLvl, b3-AutoTestCap, b2-SwitchMainCG, b1-MainCG, b0-IntegralEmCG
7000 x channel + (100 x sa) + 59		x		R	Lamp Emergency Time	0 to 254 hours
7000 x channel + (100 x sa) + 60		x		W	Rest	1-Extinguish Lamp
7000 x channel + (100 x sa) + 61		x		W	Inhibit	1-Start Inhibit mode
7000 x channel + (100 x sa) + 62		x		W	Re-Light/Reset Inhibit	1-Cancel Inhibit Mode
7000 x channel + (100 x sa) + 63		x		W	Start Function Test	1-Start Function Test
7000 x channel + (100 x sa) + 64		x		W	Start Duration Test	1-Start Duration Test
7000 x channel + (100 x sa) + 65		x		W	Stop Test	1-Stop Function/Duration Test
7000 x channel + (100 x sa) + 66		x		W	Reset Function Test Done Flag	1-Reset Function Flag
7000 x channel + (100 x sa) + 67		x		W	Reset Duration Test Done Flag	1-Reset Duration Flag

Modbus Address <small>First Address is 0</small>	ECG type			Read/ Write	Register/signal name	Possible values
	FL	EML	LED			
7000 x channel + (100 x sa) + 68		x		W	Reset Lamp Time	1-Lamp Emergency Time Reset
7000 x channel + (100 x sa) + 69		x		R/W	Store Test Execution Timeout	0 to 255 days
7000 x channel + (100 x sa) + 70		x		R/W	Store Prolong Time	0 to 127,5 minutes
7000 x channel + (100 x sa) + 71		x		R/W	Store Function Test Interval	0-Disabled, 1 to 255 days
7000 x channel + (100 x sa) + 72		x		R/W	Store Duration Test Interval	0-Disabled, 1 to 97 weeks
7000 x channel + (100 x sa) + 73		x		R/W	Store Emergency Level	0 to 100 %
7000 x channel + (100 x sa) + 74				R	Not used	Default to 0
7000 x channel + (100 x sa) + 75				R	Not used	Default to 0
7000 x channel + (100 x sa) + 76				R	Not used	Default to 0
7000 x channel + (100 x sa) + 77				R	Not used	Default to 0
7000 x channel + (100 x sa) + 78				R	Not used	Default to 0
7000 x channel + (100 x sa) + 79				R	Not used	Default to 0
7000 x channel + (100 x sa) + 80			x	R	Failure Status	b7-RefMeasurFail, b6-ThermLightLvl, b5-ThermShut, b4-CurrProtAct, b3-LoadInc, b2-LoadDec, b1-OpenC, b0-ShortC

Modbus Address <small>First Address is 0</small>	ECG type			Read/ Write	Register/signal name	Possible values
	FL	EML	LED			
7000 x channel + (100 x sa) + 81			x	R	Gear Type	b3-dcSuppPoss, b2-acSuppPoss, b1-LEDModInt, b0-LEDPowerSInt
7000 x channel + (100 x sa) + 82			x	R	Dimming Curve	0-Standard Logarithmic Dim Curve, 1-Linear Dim Curve
7000 x channel + (100 x sa) + 83			x	R	Possible Operating Modes	b3-HighCurrPulMod, b2-OutCurrContr, b1-AMModePoss, b0-PWMModePoss
7000 x channel + (100 x sa) + 84			x	R	Features	b7-PhysicSelSupp, b6-LightLvlRedReq, b5-ThermShutReq, b4-CurrProtActReq, b3-LoadIncReq, b2-LoadDecReq, b1-OpenCQ, b0-ShortCQ
7000 x channel + (100 x sa) + 85			x	R	Reference Running	0-No, 1-Yes
7000 x channel + (100 x sa) + 86			x	R	Current Protector	0-Disabled, 1-Enabled
7000 x channel + (100 x sa) + 87			x	R	Operating Mode	b4-NonLogDimCurveAct, b3-HighCurrPulModeAct, b2-OutCurrContr, b1-AMModeAct, b0-PWMModeAct
7000 x channel + (100 x sa) + 88			x	R	Fast Fade Time	0 to 27
7000 x channel + (100 x sa) + 89			x	R	Min Fast Fade Time	0 to 27
7000 x channel + (100 x sa) + 90			x	W	Reference System Power	1-Trigger DALI Power Referencing
7000 x channel + (100 x sa) + 91			x	R/W	Enable/Disable Current Protector	0-Disable, 1-Enable
7000 x channel + (100 x sa) + 92			x	R/W	Select Dimming Curve	0-Standard Logarithmic Dim Curve, 1-Linear Dim Curve
7000 x channel + (100 x sa) + 93			x	R/W	Store Fast Fade Time	0 to 27

3.4.2 DALI groups' signals

DALI supports group addressing of ballasts. Up to 16 groups can be defined in a DALI channel. In Intesis, there are up to 16 signals for each DALI group. Their Modbus addresses can be obtained applying the following formula:

$$\text{Modbus Address} = 7000 \times \text{LINE NUMBER} + (20 \times \text{GROUP NUMBER}) + \text{SIGNAL NUMBER}$$

Where:

LINE NUMBER: 0..1 (always 0 if using version with support for 1 DALI channel)
 GROUP NUMBER: 0..15 (ballast group)
 SIGNAL NUMBER: 6400..6415, see following table

Modbus address from the formula is expressed in link layer format. This is, first register address is 0.

Supported signals vary according to device type. Following abbreviations are done in the table:

- FL: Fluorescent light (device type 0)
- EML: Emergency light (device type 1)
- LED: LED module (device type 6)
- Other

Modbus Address <small>First Address is 0</small>	Ballast / Device type			Read/Write	Register/signal name	Possible values
	FL	EML	LED			
7000 * line + (20 * gr) + 6400 <small>line stands for DALI channel and is 0 or 1 gr stands for DALI group and is 0 to 15</small>	x	x	x	R/W	Arc Power Level	0 to 100 %
7000 * line + (20 * gr) + 6401	x	x	x	R/W	Arc Power Off / On	0-Off; 1-100 %
7000 * line + (20 * gr) + 6402	x	x	x	R/W	Step Down / Up	0-Step Down, 1-Step Up
7000 * line + (20 * gr) + 6403	x	x	x	W	Recall Min Level	1-Recall Min Level
7000 * line + (20 * gr) + 6404	x	x	x	W	Recall Max Level	1-Recall Max Level

Modbus Address <small>First Address is 0</small>	Ballast / Device type			Read/Write	Register/signal name	Possible values
	FL	EML	LED			
7000 * line + (20 * gr) + 6405	x	x	x	R/W	Go to Scene	0 to 15
7000 * line + (20 * gr) + 6406	x	x	x	R/W	Store Current Level as Scene	0 to 15
7000 * line + (20 * gr) + 6407	x	x	x	R/W	Clear/Remove Scene	0 to 15
7000 * line + (20 * gr) + 6408	x	x	x	R/W	Set Fade Time	0 to 15
7000 * line + (20 * gr) + 6409	x	x	x	R/W	Set Fade Rate	1 to 15
7000 * line + (20 * gr) + 6410	x	x	x	R/W	Set Min Level	0 to 100 %
7000 * line + (20 * gr) + 6411	x	x	x	R/W	Set Max Level	0 to 100 %
7000 * line + (20 * gr) + 6412	x	x	x	R/W	Set Power-on Level	0 to 100 %
7000 * line + (20 * gr) + 6413	x	x	x	R/W	Set System-failure Level	0 to 100 %

3.4.3 Broadcast signals

Broadcast signals allow to control all ballasts in the same line from an individual signal. Their Modbus addresses can be obtained applying the following formula:

$$\text{Modbus Address} = 7000 \times \text{channel} + \text{SIGNAL NUMBER}$$

Where:

LINE NUMBER; 0..1 (always 0 if using version with support for 1 DALI channel)
SIGNAL NUMBER: 6800..6815, see following table

Modbus address from the formula is expressed in link layer format. This is, first register address is 0.

Supported signals vary according to device type. Following abbreviations are done in the table:

- FL: Fluorescent light (device type 0)
- EML: Emergency light (device type 1)
- LED: LED module (device type 6)
- Other

Modbus Address <small>First Address is 0</small>	Ballast / Device type			Read/Write	Register/signal name	Possible values
	FL	EML	LED			
7000 * line + 6800 <small>line stands for DALI channel and is 0 or 1</small>	x	x	x	R/W	Arc Power Level	0 to 100 %
7000 * line + 6801	x	x	x	R/W	Arc Power Off / On	0-Off; 1-100 %

Modbus Address <small>First Address is 0</small>	Ballast / Device type			Read/Write	Register/signal name	Possible values
	FL	EML	LED			
7000 * line + 6802	x	x	x	R/W	Step Down / Up	0-Step Down, 1-Step Up
7000 * line + 6803	x	x	x	W	Recall Min Level	1-Recall Min Level
7000 * line + 6804	x	x	x	W	Recall Max Level	1-Recall Max Level
7000 * line + 6805	x	x	x	R/W	Go to Scene	0 to 15
7000 * line + 6806	x	x	x	R/W	Store Current Level as Scene	0 to 15
7000 * line + 6807	x	x	x	R/W	Clear/Remove Scene	0 to 15
7000 * line + 6808	x	x	x	R/W	Set Fade Time	0 to 15

Modbus Address <small>First Address is 0</small>	Ballast / Device type			Read/Write	Register/signal name	Possible values
	FL	EML	LED			
7000 * line + 6809	x	x	x	R/W	Set Fade Rate	1 to 15
7000 * line + 6810	x	x	x	R/W	Set Min Level	0 to 100 %
7000 * line + 6811	x	x	x	R/W	Set Max Level	0 to 100 %
7000 * line + 6812	x	x	x	R/W	Set Power-on Level	0 to 100 %
7000 * line + 6813	x	x	x	R/W	Set System-failure Level	0 to 100 %
7000 * line + 6814	x			R/W	Broadcast Multicontrol	0-Off, 1-100%, 2-StpUp, 3-StpDwn, 1XX-GoScn, 2XX-StoreScn, 3XX-RmvScn, 1XXX-FdRate, 2XXX-FdTime, 3XXX-MinLvl, 4XXX-MaxLvl, 5XXX-PwrOnLvl, 6XXX-SysFailLvl

3.4.4 Input Devices

Input device signals offer information of the status of each input device/Instance.

$$\text{Modbus Address} = 14000 + (640 * \text{LINE NUMBER}) + (10 * \text{INPUT DEVICE INDEX}) + \text{INSTANCE INDEX} + (1280 * \text{SIGNAL INDEX})$$

Where:

- LINE NUMBER: 0..1 (always 0 if using version with support for 1 DALI channel)
- INPUT DEVICE INDEX: 0..63
- INSTANCE INDEX: 0..9
- SIGNAL INDEX: 0..1

The Modbus address in the formula is in a 0-based register format, meaning the first register address is 0.

Modbus Address <small>First Address is 0</small>	Read/ Write	Register/signal name	Signal index	Possible values
$14000 + (640 * \text{LINE NUMBER}) + (10 * \text{INPUT DEVICE INDEX}) + \text{INSTANCE INDEX} + (1280 * \text{SIGNAL INDEX})$ <small>line stands for DALI channel and is 0 or 1</small>	R	Occupancy InputValue	0	[0, 1, 2, 3] - [Vacant + No Mov, Vacant + Mov, occupied + No Mov, Occupied + Mov]
		Light InputValue	0	Lux
		Push Button-Press events	0	0-Released, 1-Pressed / Event bitfields b0-Button released, b1-Button pressed, b2-Short press, b3-Double press, b4-Long press start, b5-Long press
		Push button-Button Stuck	1	Button free=0, Button stuck=1
		Absolute Inputs	0	Percent: 0...100% / Absolute value: 0... (2^resolution -1)

4 Connections

Find below information regarding the Intesis connections available.

INMBSDAL0640200 (1 DALI channel)

INMBSDAL1280200 (2 DALI channels)

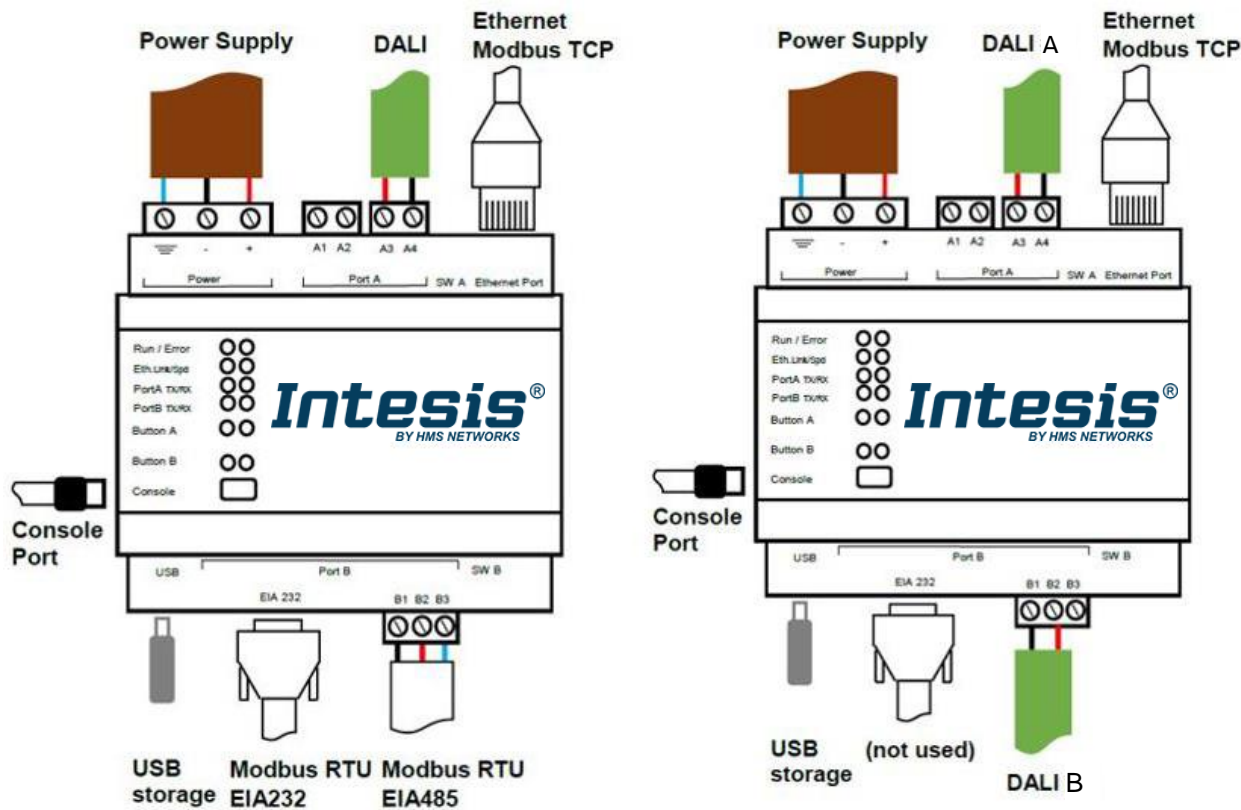

Figure 4.1 Gateway's connections

Power Supply

Must use NEC Class 2 or Limited Power Source (LPS) and SELV rated power supply. Respect polarity applied of terminals (+) and (-). Be sure the voltage applied is within the range admitted (check section 0). The power supply can be connected to earth but only through the negative terminal, never through the positive terminal.

Ethernet / Modbus TCP

Connect the cable coming from the IP network to the connector ETH of the gateway. Use an Ethernet CAT5 cable. If communicating through the LAN of the building, contact the network administrator and make sure traffic on the port used is allowed through all the LAN path (check the gateway user manual for more information). With factory settings, after powering up the gateway, DHCP will be enabled for 30 seconds. After that time, if no IP is provided by a DHCP server, the default IP 192.168.100.246 will be set.

PortA / DALI A

Connect the DALI bus to connectors A3 (DA+) A4 (DA-) of gateway's PortA. Intesis provides 16VDC (+/-2%) DALI voltage to the bus.

PortB / Modbus RTU (INMBSDAL0640200 / 1 DALI channel)

Connect the EIA485 bus to connectors B1 (B+), B2 (A-) and B3 (SNGD) of gateway's PortB. Respect the polarity.

Remember the characteristics of the standard EIA485 bus: maximum distance of 1200 meters, maximum 32 devices connected to the bus, and in each end of the bus it must be a termination resistor of 120 Ω. The gateway has an internal bus biasing circuit that incorporates the termination resistor. If you install the gateway in one of the ends of the bus, then do not install an additional termination resistor in that end.

PortB / DALI B (INMBSDAL1280200 / 2 DALI channels)

Connect the DALI bus to connectors B1 (DA-) B2 (DA+) of gateway's PortA. Intesis provides 16VDC (+/-2%) DALI voltage to the bus.

Console Port

Connect a mini-type B USB cable from your computer to the gateway to allow communication between the Configuration Software and the gateway. Remember that Ethernet connection is also allowed.

USB

Connect a USB storage device (not a HDD) if required. Check port characteristics on section 0.

Ensure proper space for all connectors when mounted (see section 8).

4.1 Powering the device

A power supply working with any of the voltage range allowed is needed (check section 0). Once connected the RUN led (Figure above) will turn on.

WARNING! In order to avoid earth loops that can damage the gateway and/or any other equipment connected to it, we strongly recommend the use of DC power supplies, floating or with the negative terminal connected to earth. **Never use a DC power supply with the positive terminal connected to earth.**

4.2 Connection to DALI channel.

Connect + and – terminals of the DALI bus of your DALI channel to Intesis' DALI port. Bus has polarity, but most DALI devices are polarity insensitive.



NOTE: The gateway comes with the DALI power supply disabled out of the box in case you are using one on the Bus.

If you want the gateway to be the main power supply on the DALI line you can enable it from MAPS, the change would be effective after a transfer of the MAPS configuration to the gateway. In the absence of power in the DALI bus you would have no communication and a hardware error would appear on the hardware test.

If using an external DALI power supply, ensure that:

- Is a DALI-2 standard and certified under the DiiA guidelines.
- Polarity is the same in between the gateway and the power supply(ies) on the DALI bus.
- That you follow the DALI standard guidelines for powering the Bus.

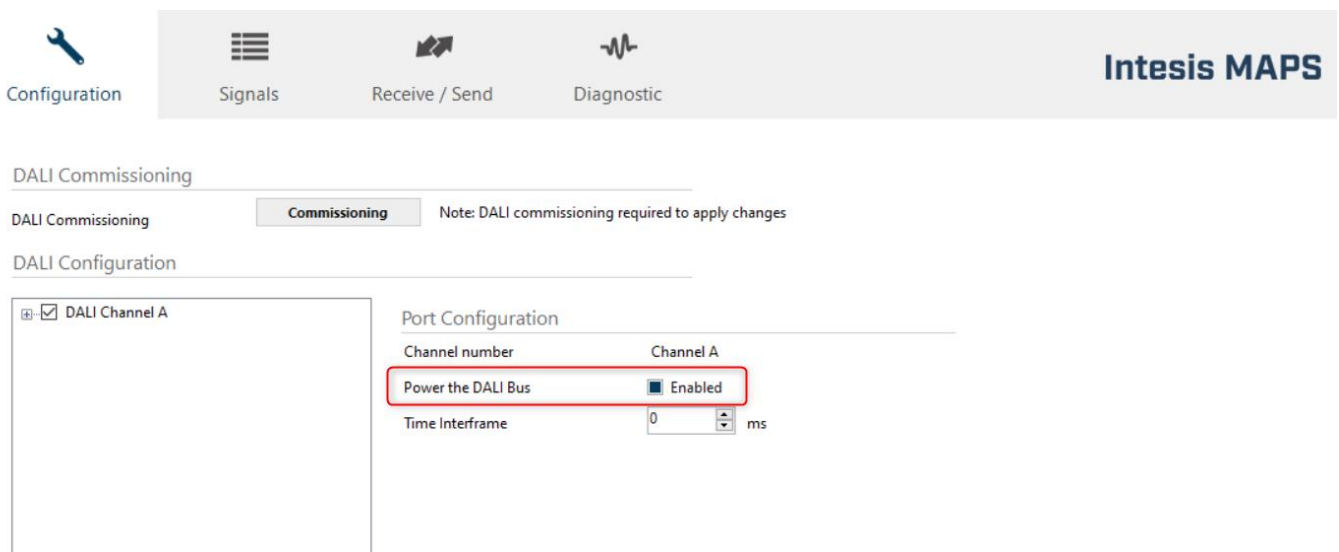

Figure 4.2 DALI bus power configuration

Having your DALI channel powered up, you can perform a quick DALI connectivity test by pressing Port A / Port B buttons:

- When pressing Port A / Port B button, a broadcast command that will toggle the ballasts between 100% and 0% level will be sent.
- After 30s timeout of not pressing the button, ballasts will return back to its original level.

DALI commands coming from Modbus will continue to be executed while doing this test.

4.3 Connection to Modbus

4.3.1 Modbus TCP

Connect the communication cable coming from the network hub or switch to the Ethernet port of Intesis. The cable to be used shall be a straight Ethernet UTP/FTP CAT5 cable.

4.3.2 Modbus RTU

Connect the communication cable coming from the Modbus network to the port marked as Port B of Intesis. Connect the EIA485 bus to connectors B1 (-), B2 (+) and B3 (SNGD) of gateway's PortB. Respect the polarity.

Remember the characteristics of the standard EIA485 bus: maximum distance of 1200 meters, maximum 32 devices (without repeaters) connected to the bus, and in each end of the bus it must be a termination resistor of 120 Ω . The gateway has an internal bus biasing circuit that incorporates the termination resistor. Bus biasing and termination resistor for EIA485 can be enabled for PortB by means of a dedicated DIP switch.

4.4 Connection to PC (Configuration tool)

This action allows the user to have access to configuration and monitoring of the device. Two methods to connect to the PC can be used:

- **Ethernet:** Using the Ethernet port of the Intesis.
- **USB cable:** To connect the device to the PC, the USB cable supplied should be plugged to the USB Console port.

5 Status LEDs and push buttons

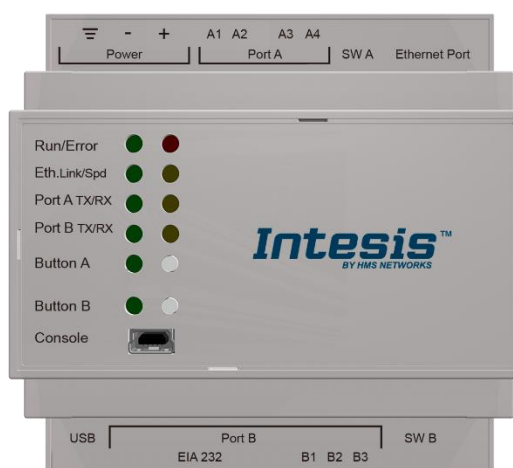

LED	Colour	Indication
Run	Off	No power
	Green	Device powered and working.
Error	Off	No error
	Red	Error
Port A (Tx/Rx) – DALI A	Off	There is no activity on this port.
	Tx - Blinking green	Every data packet sent to UFO device it blinks
	Rx – Blinking yellow	Every data packet received from UFO device it blinks
Port B (Tx/Rx) – DALI B (INMBSDAL1280200 – 2 Channels)	Off	There is no activity on this port.
	Tx - Blinking green	Every data packet sent to UFO device it blinks
	Rx – Blinking yellow	Every data packet received from UFO device it blinks
Port B (Tx/Rx) – Modbus (INMBSDAL0640200 – 1 Channel)	Off	There is no activity on this port.
	Tx - Blinking green	Every data packet sent to the network it blinks
	Rx – Blinking yellow	Every data packet received from a slave device it blinks
Button A – DALI A	Green	Indicates status of last command sent from the button to 1 or 2 chanesl in the case of the INMBSDAL1280200 (On-RECALL_MAX_LEVEL, Off-OFF) After 30 secs of not pushing the button, the LED turns OFF and next time the button is pushed it will begin with RECALL_MAX_LEVEL
Button B – DALI B (INMBSDAL1280200 – 2 Channels)	Green	It doesn't have any functionality
Button B – Modbus RTU (INMBSDAL0640200 – 1 Channel)	Green	It doesn't have any functionality

Push button	Functionality
Button A – DALI A	Sends to broadcast, alternatively: RECALL_MAX_LEVEL, OFF to 1 or the 2 channels (in the case of the INMBSDAL1280200)
Button B – DALI B (INMBSDAL1280200 – 2 Channels)	It doesn't have any functionality. It can be configured from Intesis MAPS software for USB configuration
Button B – Modbus RTU (INMBSDAL0640200 – 1 Channel)	It doesn't have any functionality. It can be configured from Intesis MAPS software for USB configuration

6 Set-up process and troubleshooting

6.1 Pre-requisites

It is necessary to have the Modbus RTU or TCP master/client device (BMS side device) operative and properly connected to the corresponding port of the gateway. It is also required to have a DALI installation connected to the gateway, in its respective DALI port/s.

Connectors, connection cables, PC for the usage of the Configuration Tool and other auxiliary material, if needed, are not supplied by Intesis for this standard integration.

Items supplied with this product for this integration are:

- Intesis gateway.
- Link to download the configuration tool.
- USB Console cable to communicate with Intesis.
- Product documentation.

6.2 Intesis MAPS. Configuration & monitoring tool for Intesis

6.2.1 Introduction

Intesis MAPS is a Windows® compatible software developed specifically to monitor and configure Intesis new generation gateways.

The installation procedure and main functions are explained in the *Intesis MAPS User Manual*. This document can be downloaded from the product website at www.intesis.com

In this section, only the specific case of DALI to Modbus will be covered.

Please check the Intesis MAPS user manual for specific information about the different parameters and how to configure them.

6.2.2 Connection

To configure the Intesis connection parameters press on the **Connection** button in the *menu bar*.

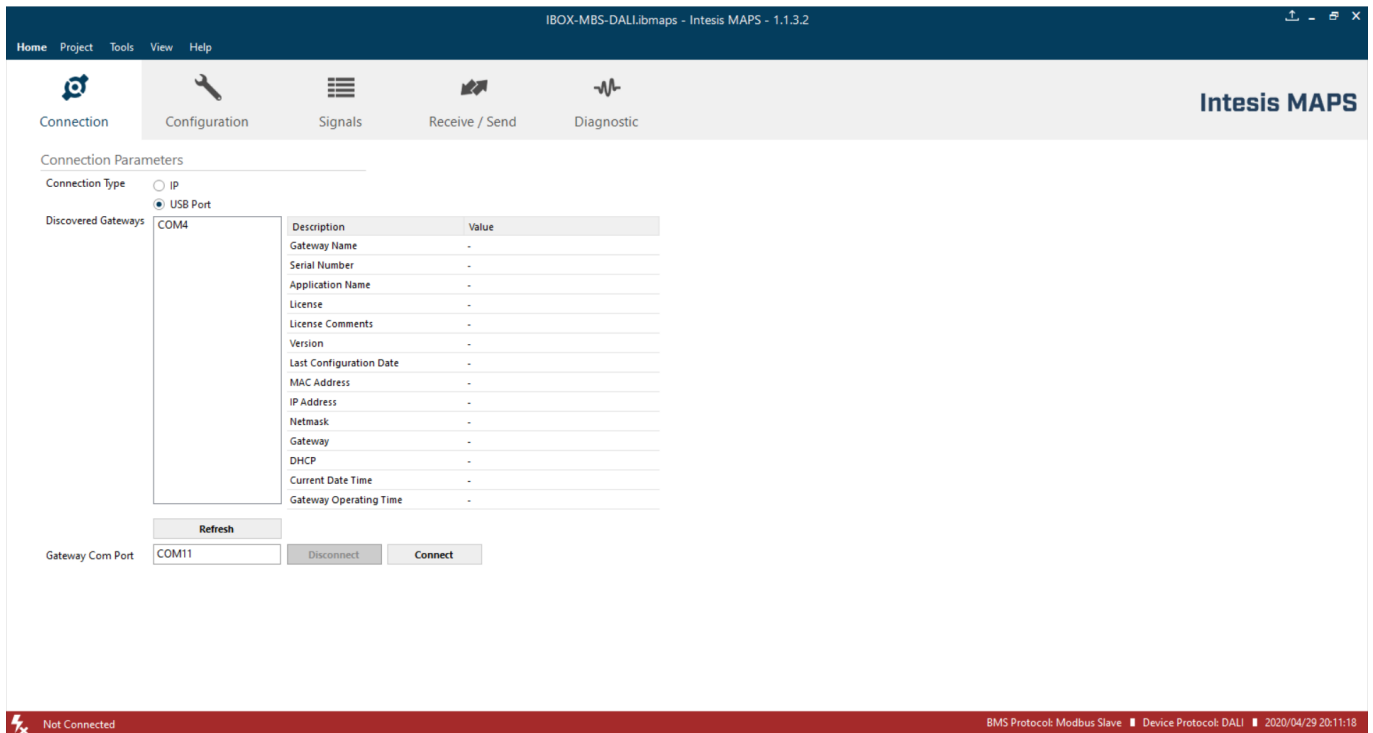

Figure 6.1 MAPS connection

6.2.3 Configuration tab

Select the **Configuration** tab to configure the connection parameters. Three subsets of information are shown in this window: General (Gateway general parameters), Modbus Slave (Modbus interface configuration) and DALI (DALI channel/s and DALI devices configuration).

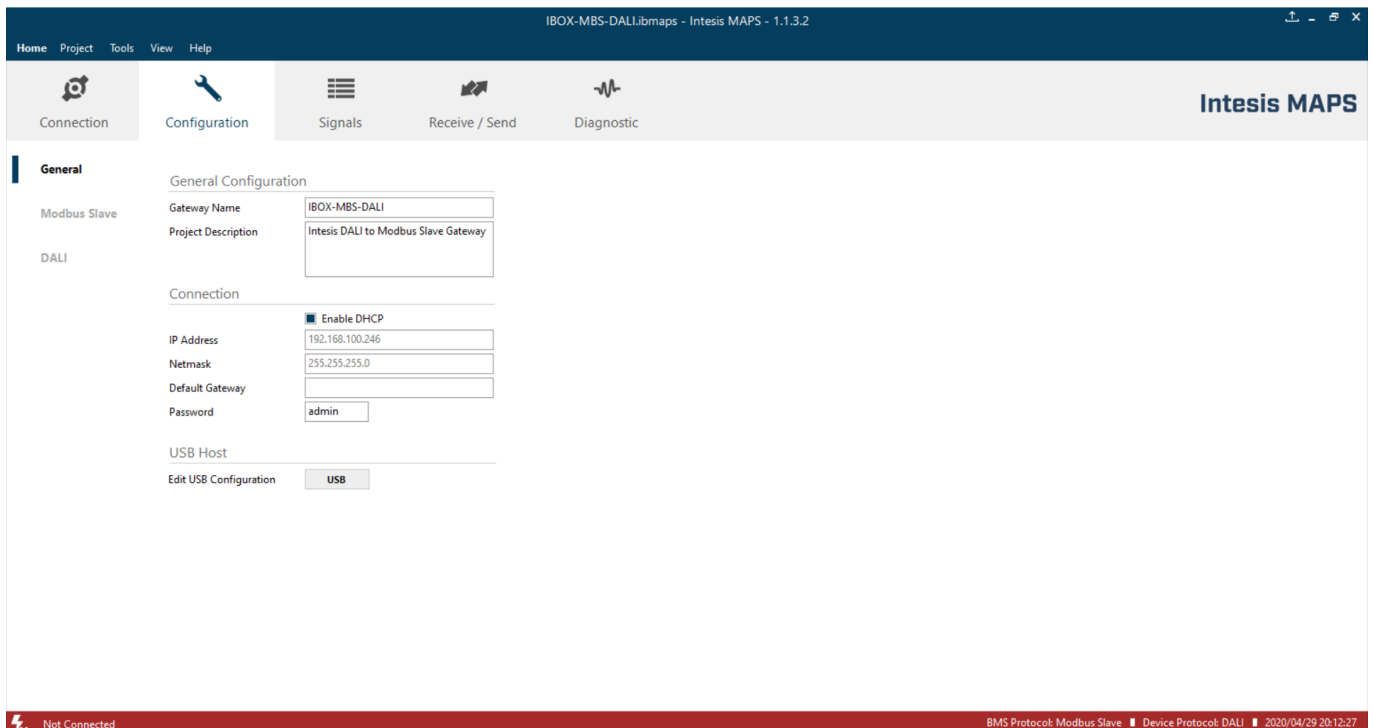

Figure 6.2 Intesis MAPS configuration tab

General, Modbus Slave and DALI tabs are explained in Intesis MAPS user manual for Intesis Modbus Server Series.

6.2.4 Signals

All available registers, its corresponding description and other main parameters are listed in the signals tab. Depending on the configuration of the Modbus Addresses parameter, on the Modbus Slave tab, active signals may vary, and edition may be allowed or not.

For more information about configuration of Modbus Addresses parameter, see the [Intesis MAPS Modbus Server User Manual](#).

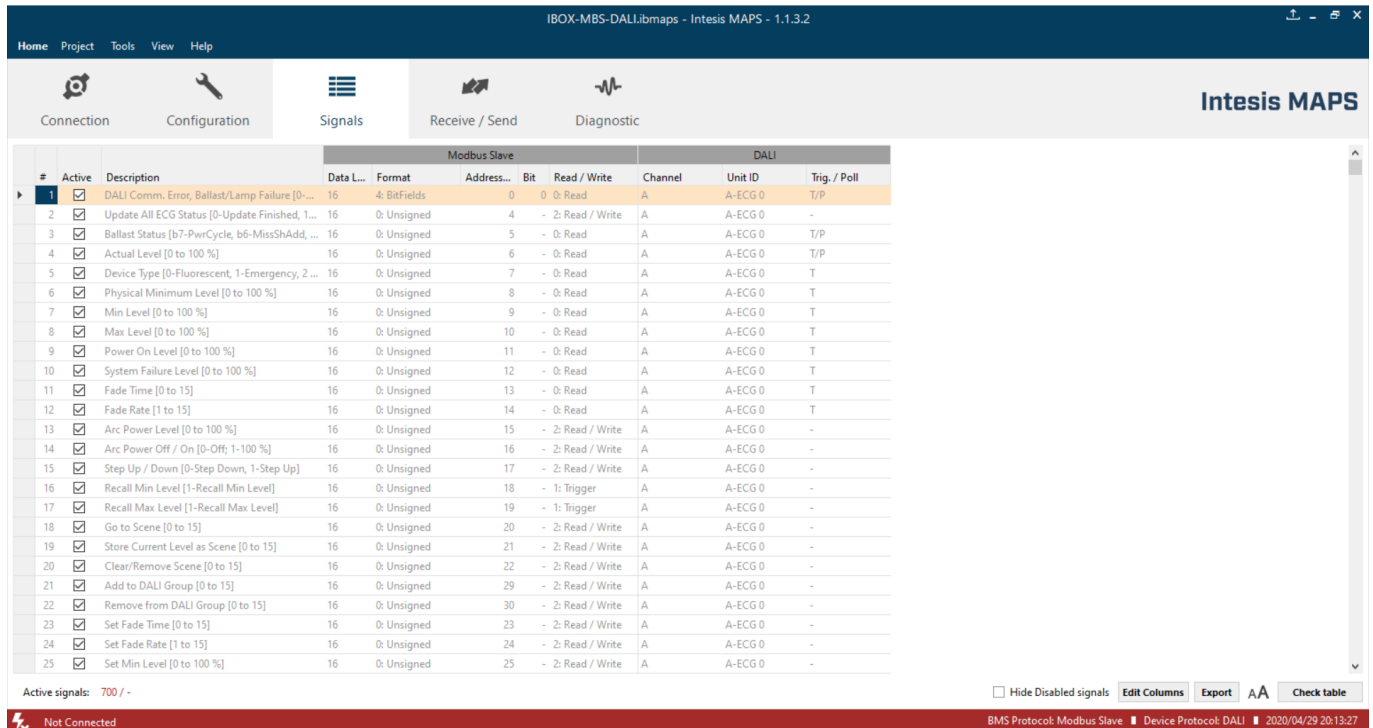

Figure 6.3 Intesis MAPS Signals tab

6.2.5 Sending the configuration to Intesis

When the configuration is finished, follow the steps to program the gateway.

- 1.- Click on **Save** button to save the project to the project folder on your hard disk (more information in Intesis MAPS User Manual).
- 2.- You will be prompted to generate the configuration file to be sent to the gateway.
 - a.- If **Yes** is selected, the file containing the configuration for the gateway will be generated and saved also into the project folder.
 - b.- If **NO** is selected, remember that the binary file with the project needs to be generated before the Intesis starts to work as expected.
- 3.- Press the **Send File** button to send the binary file to the Intesis device. The process of file transmission can be monitored in the Intesis Communication Console window. Intesis will reboot automatically once the new configuration is loaded.

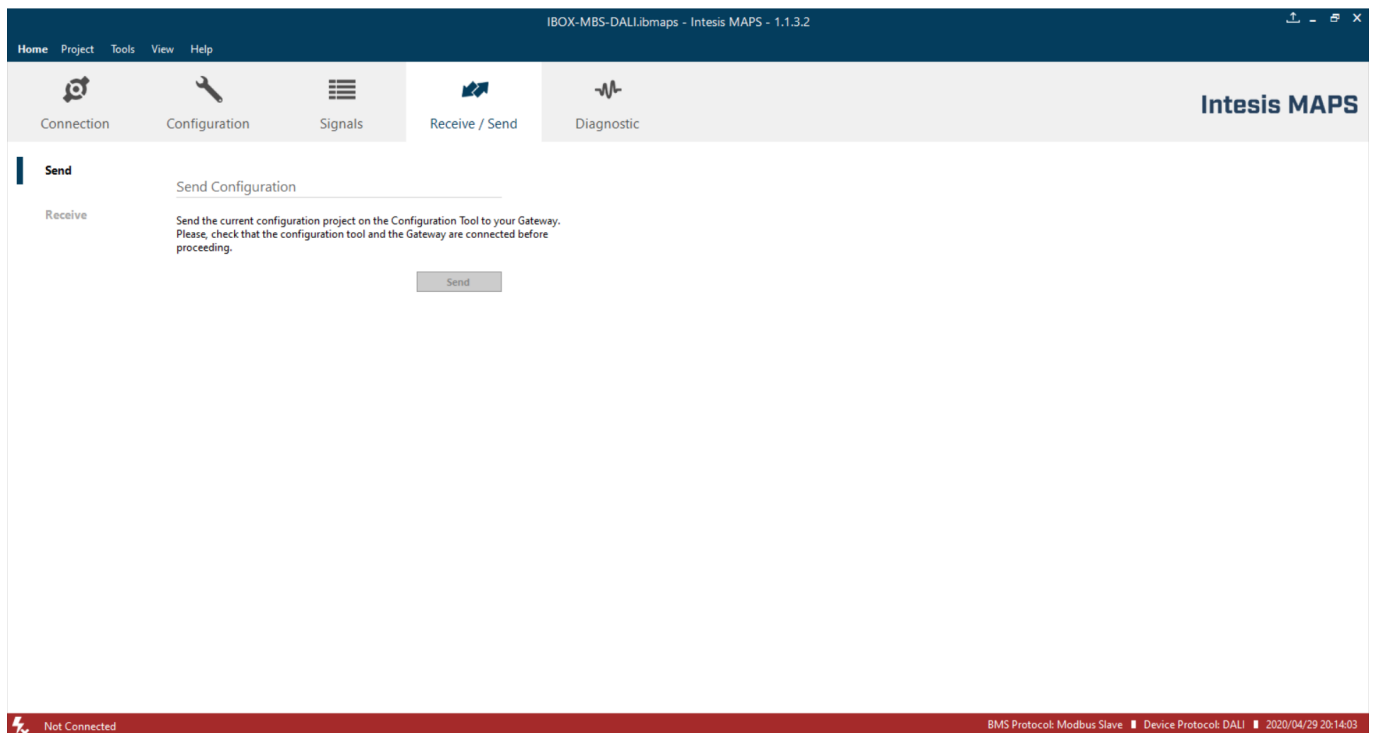

Figure 6.4 Intesis MAPS Receive/Send tab

After any configuration change, do not forget to send the configuration file to the Intesis using the button “Send”.

6.2.6 Diagnostic

To help integrators in the commissioning tasks and troubleshooting, the Configuration Tool offers some specific tools and viewers.

In order to start using the diagnostic tools, the connection with the Gateway must be established.

The Diagnostic section is composed by two main parts: Tools and Viewers.

- **Tools**
Use the tools section to check the current hardware status of the box, log communications into compressed files to be sent to the support, change the Diagnostic panels' view or send commands to the gateway.
- **Viewers**
In order to check the current status, viewer for the Internal and External protocols are available. It is also available a generic Console viewer for general information about communications and the gateway status. User can use a Signals Viewer to simulate the BMS behavior or to check the current values in the system.

#	Modbus	DALI	Description	Format	Address	Read / Write	Unit ID	Trig. / Poll
163			Arc Power Level [0 to 100 %]	0: Unsigned	6400	2: Read / Write	Group 0	-
164			Arc Power Off / On [0-Off; 1-100 %]	0: Unsigned	6401	2: Read / Write	Group 0	-
165			Step Down / Up [0-Step Down, 1-Step Up]	0: Unsigned	6402	2: Read / Write	Group 0	-
166			Recall Min Level [1-Recall Min Level]	0: Unsigned	6403	1: Trigger	Group 0	-
167			Recall Max Level [1-Recall Max Level]	0: Unsigned	6404	1: Trigger	Group 0	-
168			Go to Scene [0 to 15]	0: Unsigned	6405	2: Read / Write	Group 0	-
169			Store Current Level as Scene [0 to 15]	0: Unsigned	6406	2: Read / Write	Group 0	-
170			Clear/Remove Scene [0 to 15]	0: Unsigned	6407	2: Read / Write	Group 0	-
171			Set Fade Time [0 to 15]	0: Unsigned	6408	2: Read / Write	Group 0	-
172			Set Fade Rate [1 to 15]	0: Unsigned	6409	2: Read / Write	Group 0	-
173			Set Min Level [0 to 100 %]	0: Unsigned	6410	2: Read / Write	Group 0	-
174			Set Max Level [0 to 100 %]	0: Unsigned	6411	2: Read / Write	Group 0	-
175			Set Power-on Level Time [0 to 100 %]	0: Unsigned	6412	2: Read / Write	Group 0	-
176			Set System-failure Level [0 to 100 %]	0: Unsigned	6413	2: Read / Write	Group 0	-
178			Arc Power Level [0 to 100 %]	0: Unsigned	6420	2: Read / Write	Group 1	-
179			Arc Power Off / On [0-Off; 1-100 %]	0: Unsigned	6421	2: Read / Write	Group 1	-
180			Step Down / Up [0-Step Down, 1-Step Up]	0: Unsigned	6422	2: Read / Write	Group 1	-
181			Recall Min Level [1-Recall Min Level]	0: Unsigned	6423	1: Trigger	Group 1	-
182			Recall Max Level [1-Recall Max Level]	0: Unsigned	6424	1: Trigger	Group 1	-
183			Go to Scene [0 to 15]	0: Unsigned	6425	2: Read / Write	Group 1	-
184			Store Current Level as Scene [0 to 15]	0: Unsigned	6426	2: Read / Write	Group 1	-
185			Clear/Remove Scene [0 to 15]	0: Unsigned	6427	2: Read / Write	Group 1	-

Figure 6.5 Diagnostic

More information about the Diagnostic section can be found in Intesis MAPS user manual for Intesis Modbus Server Series.

6.3 Set-up procedure

1. Install Intesis MAPS on your laptop, use the setup program supplied for this and follow the instructions given by the Installation wizard.
2. Install Intesis in the desired installation site. Installation can be on DIN rail or on a stable not vibrating surface (DIN rail mounted inside a metallic industrial cabinet connected to ground is recommended).
3. If using Modbus RTU, connect the communication cable coming from the EIA485 port of the Modbus RTU installation to the port marked as Port B of Intesis (More details in section 4).

If using, Modbus TCP, connect the communication cable coming from the Ethernet port of the Modbus TCP installation to the port marked as Ethernet Port of Intesis (More details in section 4).

4. Connect the communication cable coming from DALI network to the port marked as Port A of Intesis (More details in section 4).
5. If using two DALI channels, connect communication cable coming from second DALI network to the port marked as Port B of Intesis (More details in section 4).
6. Power up Intesis. The supply voltage should be any of the voltage range allowed (check section 0). Take care of the polarity of the supply voltage applied.

WARNING! In order to avoid earth loops that can damage Intesis and/or any other equipment connected to it, we strongly recommend the use of DC power supplies, floating or with the negative terminal connected to earth. **Never use a DC power supply with the positive terminal connected to earth.**

7. If you want to connect using IP, connect the Ethernet cable from the laptop PC to the port marked as Ethernet of Intesis (More details in section 4).

If you want to connect using USB, connect the USB cable from the laptop PC to the port marked as Console of Intesis (More details in section 4).

8. Open Intesis MAPS, create a new project for Modbus and select the INMBSDAL---0200-Template project.
9. Modify the configuration as desired, save it and download the configuration file to Intesis as explained in section 6.2.5 .
10. Visit the Diagnostic section, enable COMMS and check that there is communication activity, some TX frames and some other RX frames. This means that the communication with the Centralized Controller and Modbus Master devices is OK. In case there is no communication activity between Intesis and the Centralized Controller and/or Modbus devices, check that those are operative: check the baud rate, the communication cable used to connect all devices and any other communication parameter.

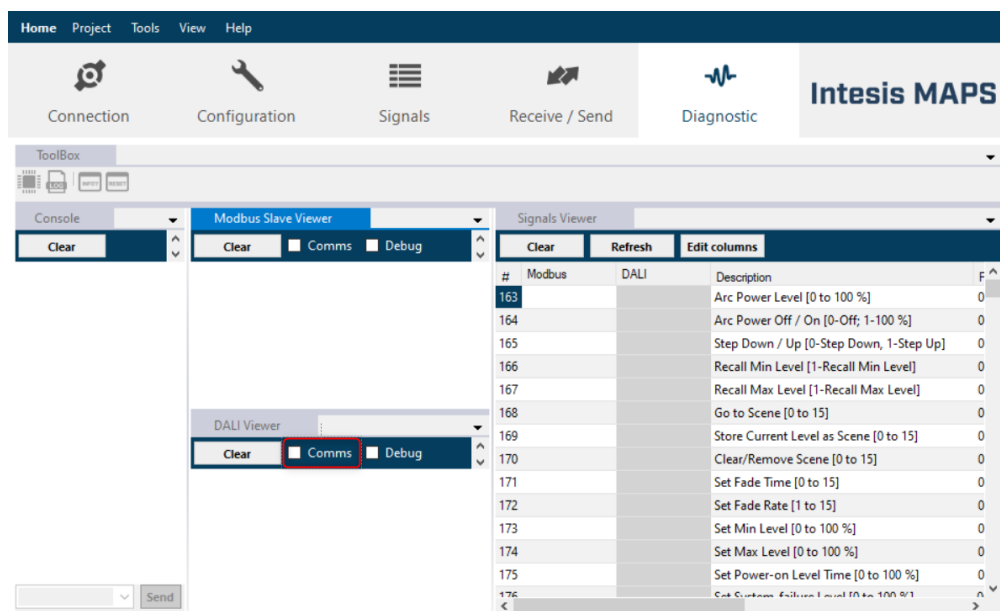

Figure 6.6 Enable COMMS

7 Electrical & Mechanical Features



Enclosure	Plastic, type PC (UL 94 V-0) Net dimensions (d×w×h): 90x88x56 mm Recommended space for installation (d×w×h): 130x100x100mm Color: Light Grey. RAL 7035	Battery	Size: Coin 20mm x 3.2mm Capacity: 3V / 225mAh Type: Manganese Dioxide Lithium
Mounting	Wall. DIN rail EN60715 TH35.	Console Port	Mini Type-B USB 2.0 compliant 1500VDC isolation
Terminal Wiring (for power supply and low-voltage signals)	Per terminal: solid wires or stranded wires (twisted or with ferrule) 1 core: 0.5mm ² ... 2.5mm ² 2 cores: 0.5mm ² ... 1.5mm ² 3 cores: not permitted	USB port	Type-A USB 2.0 compliant Only for USB flash storage device (<i>USB pen drive</i>) Power consumption limited to 150mA (<i>HDD connection not allowed</i>)
Power	1 x Plug-in screw terminal block (3 poles) Positive, Negative, Earth 24VDC +/-10%	Push Button	See Status LEDs and Push Buttons
Ethernet	1 x Ethernet 10/100 Mbps RJ45 2 x Ethernet LED: port link and activity	Operation Temperature	0°C to +50°C
Port A	1 x DALI port (Plug-in screw terminal block orange 2 poles) 1500VDC isolation from other ports DALI guaranteed power: 235mA DALI maximum power 250 mA Voltage rating: 16VDC 1 x Plug-in screw terminal block green (2 poles) Reserved for future use	Operational Humidity	5 to 95%, no condensation
Switch A (SWA)	1 x DIP-Switch for serial EIA485 configuration: Reserved for future use	Protection	IP20 (IEC60529)
PORT B	<i>INMBSDAL0640200</i> 1 x Serial EIA232 (SUB-D9 male connector) Pinout from a DTE device 1500VDC isolation from other ports (except PORT B: EIA485) 1 x Serial EIA485 Plug-in screw terminal block (3 poles) A, B, SGND (Reference ground or shield) 1500VDC isolation from other ports (except PORT B: EIA232) <i>INMBSDAL1280200</i> 1 x DALI port (Plug-in screw terminal block green 2 poles) 1500VDC isolation from other ports DALI guaranteed power: 235mA DALI maximum power 250 mA Voltage rating: 16VDC	LED Indicators	10 x On board LED indicators 1 x Error LED 1 x Power LED 2 x Ethernet Link/Speed 2 x Port A TX/RX 2 x Port B TX/RX 1 x Button A indicator 1 x Button B indicator
Switch B (SWB)	1 x DIP-Switch for serial EIA485 configuration: Position 1: ON: 120 Ω termination active Off: 120 Ω termination inactive Position 2-3: ON: Polarization active Off: Polarization inactive		

8 Dimensions

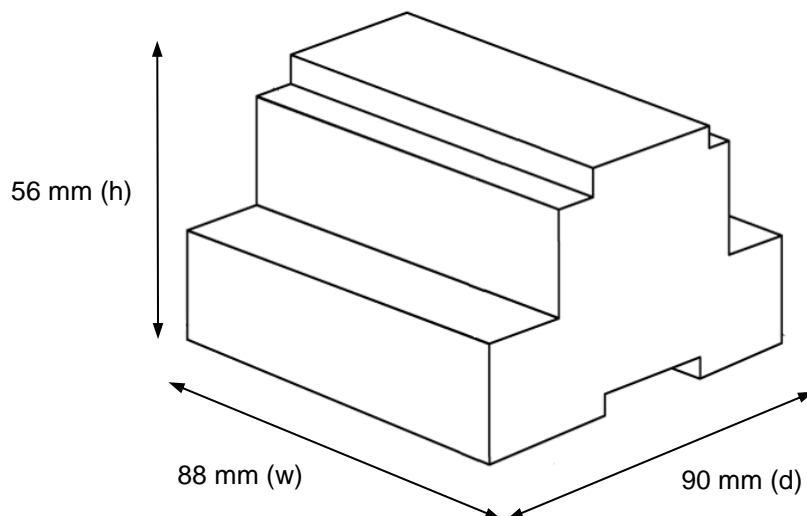

Recommended available space for its installation into a cabinet (wall or DIN rail mounting), with space enough for external connections

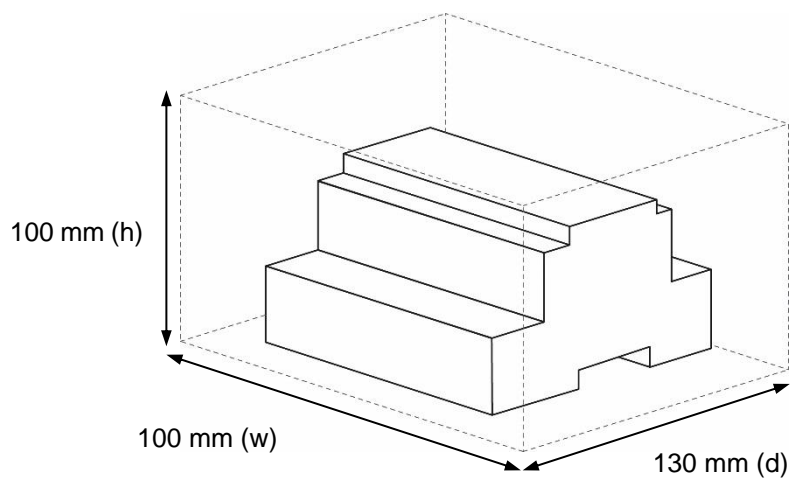

Annex A – Quick setup and commissioning of a DALI network

This section provides a summary on commissioning a DALI channel using MAPS software tool. The process of commissioning involves:

- Scanning the existing ballasts (ECGs) and sensors (Input Devices) in the DALI network
- Identifying their physical location
- Obtaining or setting up device short addresses
- Obtaining or editing devices configuration parameters (pre-set levels, scenes, groups addressing...)

In that process, using MAPS, two workflows are possible for the commissioning:

1. “Device declaration first”: First declaring or instantiating in MAPS the envisaged (planned) devices in the installation, setting up values for all their configuration parameters, and then scanning the network for existing devices. Process finalizes with assignation and download of planned configuration parameters (including short addresses) with existing devices in the installation.
2. “Existing devices scan first”: Alternatively, and more common, it is possible to scan first the DALI network for existing devices, obtain their existing configuration (which will be default/factory if the devices are new), then change these parameters to match the desired ones (short address, pre-set levels, scenes...) and load the devices with the new configuration.

Typically, “Existing devices scan first” method will be used when all commissioning is done at the installation itself, as it starts with a DALI bus scan. “Device declaration first” allows to do some work in advance, defining the configuration parameters for the ballasts and sensors before accessing the actual installation. It is possible to understand the “Device declaration first” as a previous step that can (but not must) be done before effectively scanning the network for devices (“Existing devices scan first”), in order to advance configuration work (definition of pre-set levels, DALI groups, scene values, ...).

It is perfectly possible to mix the two methods. This is, configure a certain number of ballasts declaring them in MAPS (“Device declaration first”), and once at the installation, assign their parameters to existing ballasts and sensors. Whenever more devices are installed, they can be added by scanning them in the network (“Existing devices scan first”) and changing its configuration parameters to match the desired ones (without previous instantiation of them in MAPS).

1 Create project

You will need to create a new project, to do so, select 'Create New project' in MAPS start screen, and choose the 64 or the 128 version of the template for the appropriate model.

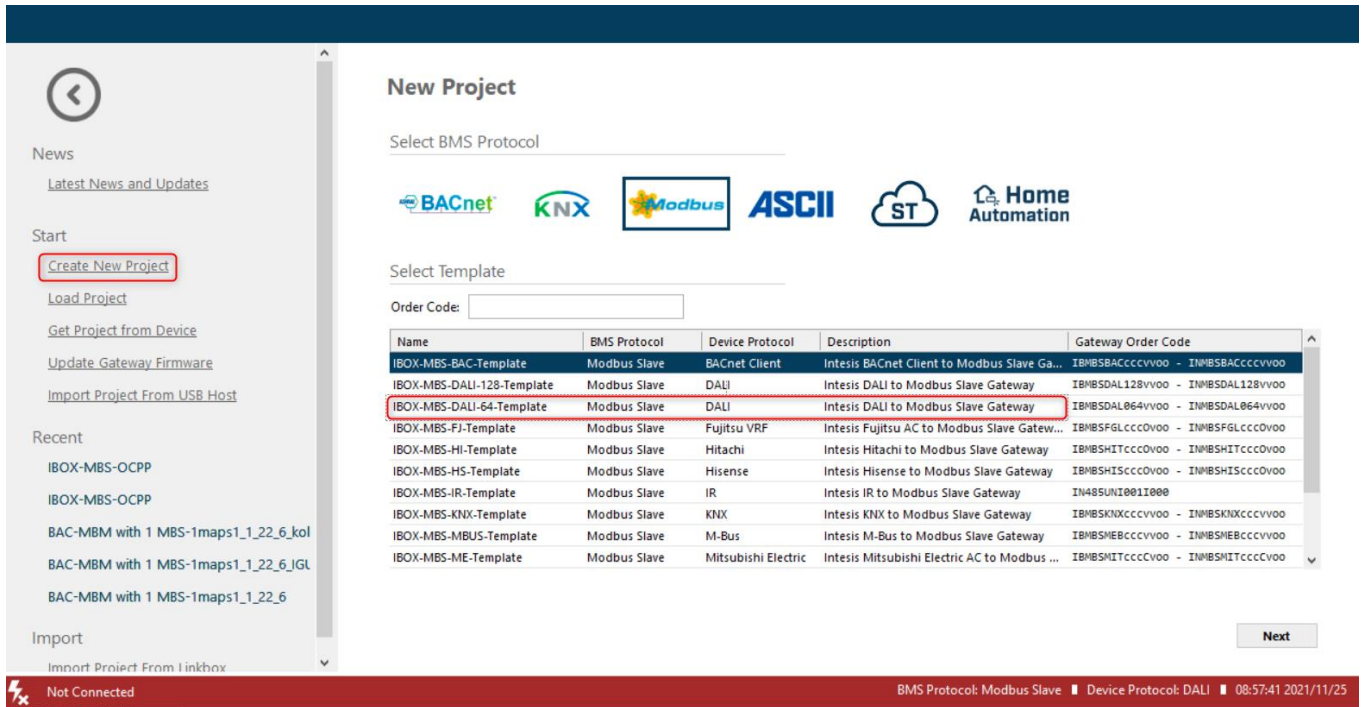

Figure A.1 New project creation

2 Device declaration in project

Once new project has been created, DALI devices can be added to the configured project, without the need of scanning them in bus.

As mentioned above, this allows defining its configuration parameters (pre-set values, groups, scenes, ...) before having actual access to the installation.

To do so, go to the 'Configuration' tab of MAPS, and select the 'DALI' section, then select ECG node to add new ECG(s), or select the Input device node to add new Input devices.

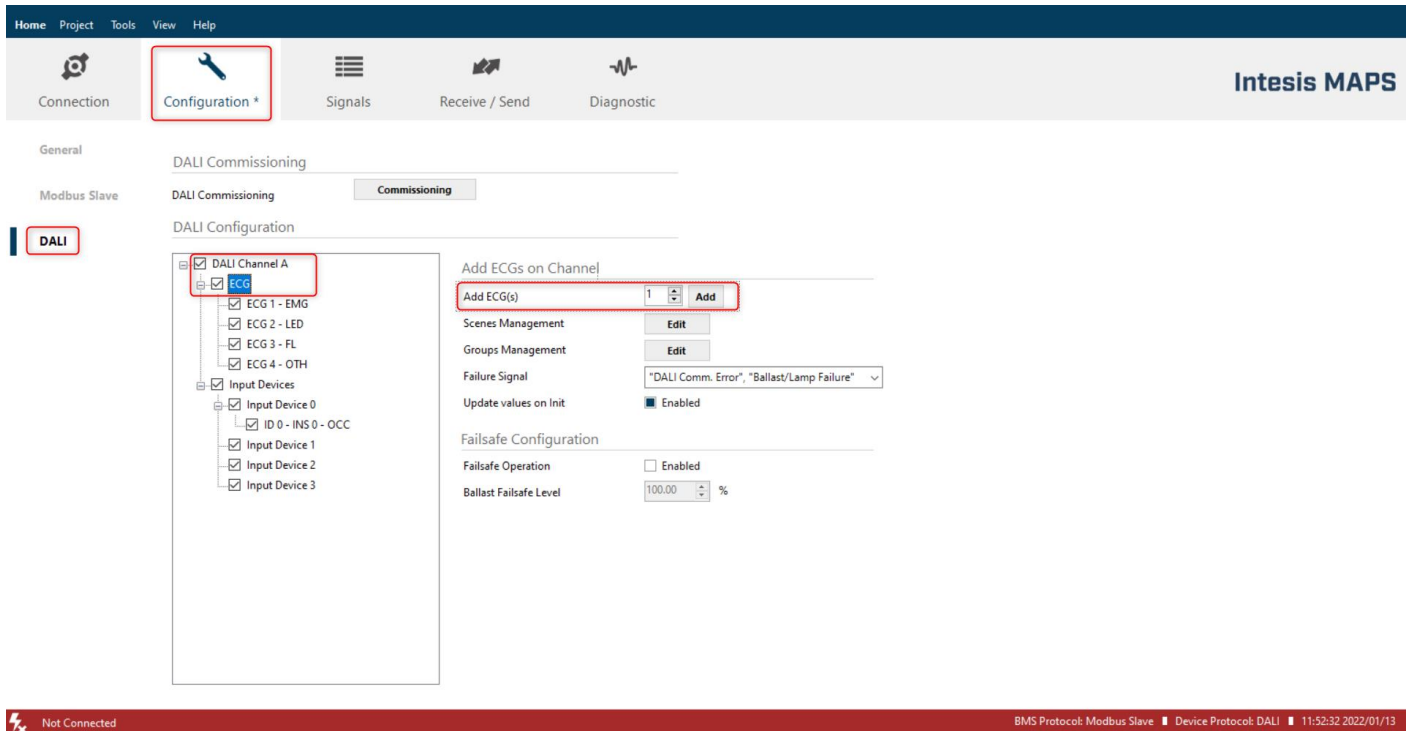

Figure A.2 Add new devices

With suitable DALI channel selected, enter in 'Add ECG(s)'/ 'Add Input device(s)' field the number of ECGs/Input devices to insert, and click button Add.

Number of desired devices will appear:

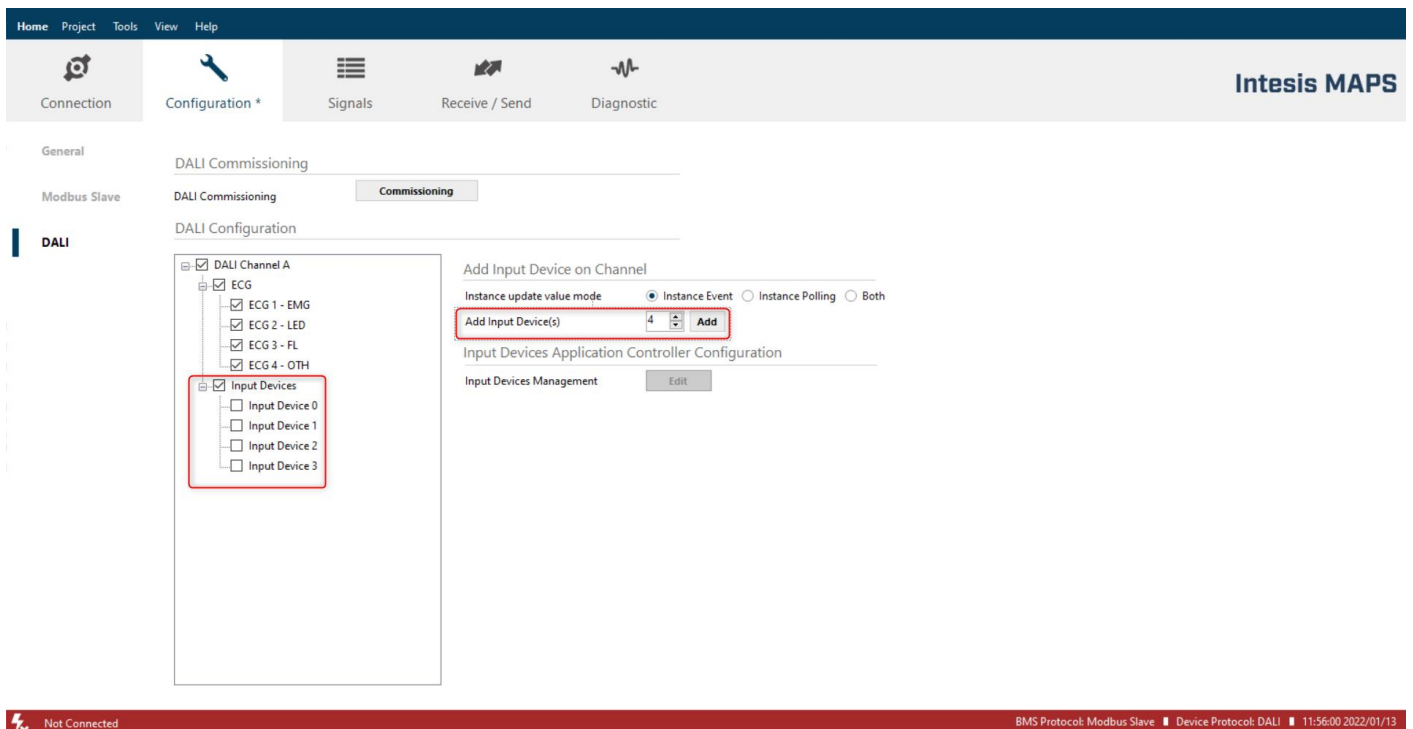

Figure A.3 Adding new Input devices

If too many devices have been added, they can be deleted by selecting them, and pressing button 'Delete ECG(s)'. Multiple selection is also possible.

The screenshot shows the Intesis MAPS software interface. At the top, there is a navigation bar with 'Home', 'Project', 'Tools', 'View', and 'Help'. Below this is a toolbar with icons for 'Connection', 'Configuration *', 'Signals', 'Receive / Send', and 'Diagnostic'. The main area is divided into sections: 'General', 'Modbus Slave', and 'DALI'. Under 'DALI', there are sub-sections for 'DALI Commissioning' and 'DALI Configuration'. The 'DALI Configuration' section shows a tree view of 'DALI Channel A' with sub-items: 'ECG', 'ECG 1 - EMG', 'ECG 2 - LED', 'ECG 3 - FL', 'ECG 4 - OTH', and 'Input Devices'. Under 'Input Devices', there are 'Input Device 0', 'Input Device 1', 'Input Device 2', and 'Input Device 3'. 'Input Device 2' is selected and highlighted with a red box. To the right of the tree view is the 'Input Device Parameters' panel, which includes fields for 'Input Device Name' and 'Short Address'. Below these are 'Input Device Instances' with a dropdown set to '1' and an 'Add' button. Further down are buttons for 'Delete Input Device(s)', 'Clone Input Device', and 'Copy Input Device'. The 'Delete' button is highlighted with a red box. At the bottom of the interface, there is a status bar showing 'Not Connected', 'BMS Protocol: Modbus Slave', 'Device Protocol: DALI', and the date/time '11:58:06 2022/01/13'.

Figure A.4 Deleting devices

Finally, for all devices in configuration, you will need to define:

- For ECGs:
 - **ECG Name** (optional): Name to ease its identification in the network
 - **Device type**: It's important that this field is suitably chosen and according to existing ballast in the network (device type 0: Fluorescent Light, device type 1: Emergency Light, device type 6: LED module or 'Other' (default) if none of the above matches the device type).
 - **Committable ECG Parameters**: This includes all pre-set values for the ballasts (min level, max level, power on level, etc), as well as group assignation and scene configuration.
- For Input Devices:
 - **Input device name** (optional): Name to ease its identification in the network.
 - **Add required Instances**: Each input device can include up to 10 different instance types (i.e. instance type 1: Push Buttons, 2: Absolute Input, 3: Occupancy sensor, or 4: Light sensor)



Remember that any changes done in the DALI parameters (Min/max level, fade, groups, scenes, input devices, etc.) required that you send them to the DALI devices through the commissioning/set all option

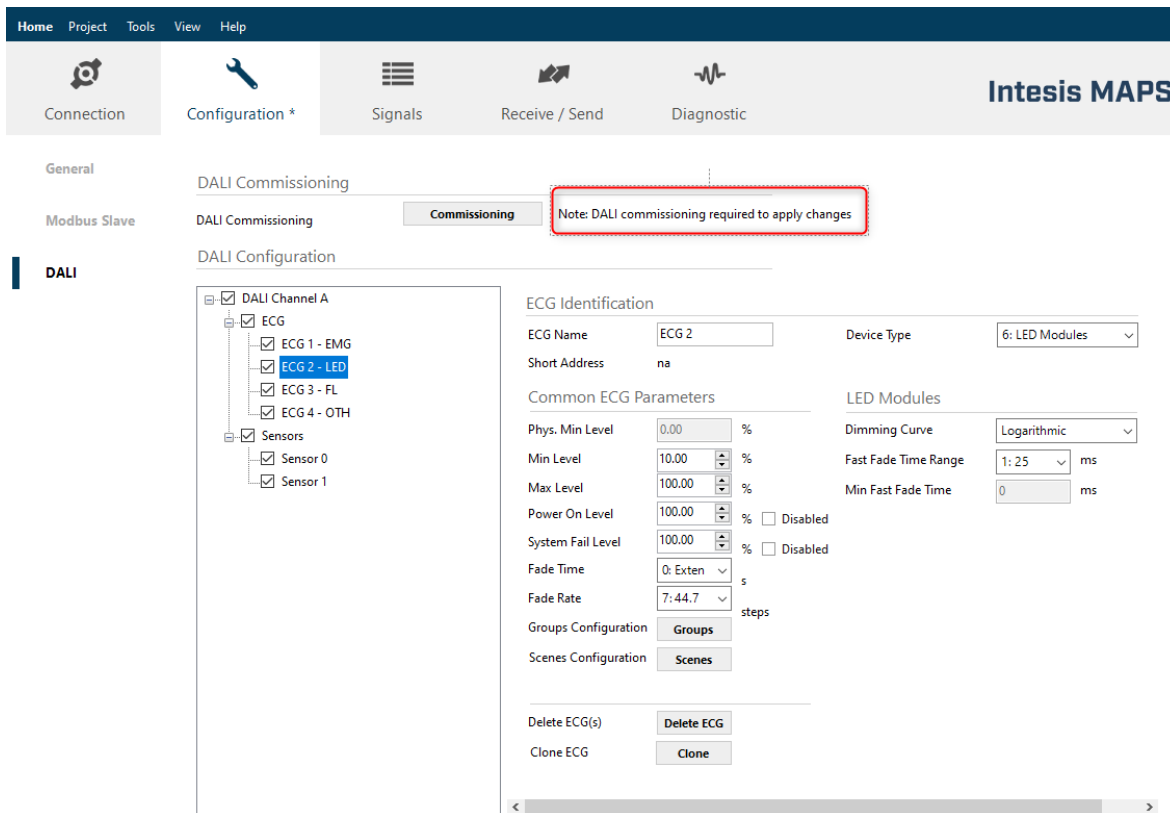

Figure A.5 Commissioning required after changing any Device parameter

3 Scan and commissioning of devices

First you need to get MAPS connected to the Intesis device. To do so, go to 'Connection' tab of MAPS. There, Select your device from the list of scanned devices.

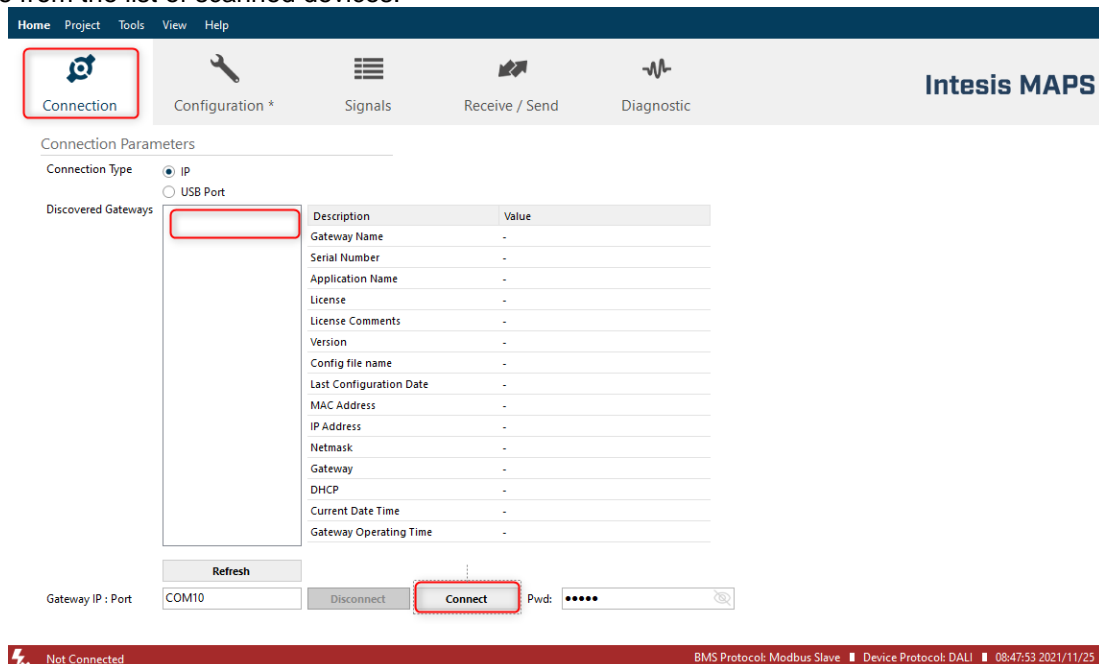

Figure A.6 Connecting MAPS to the Intesis

Finally, click on button 'Connect' in order to establish connection. Bar at the bottom in MAPS main window will become green, switching from 'Not Connected' to 'Connected'.

Now go back to 'Configuration' tab of MAPS, and click on button 'Commissioning':

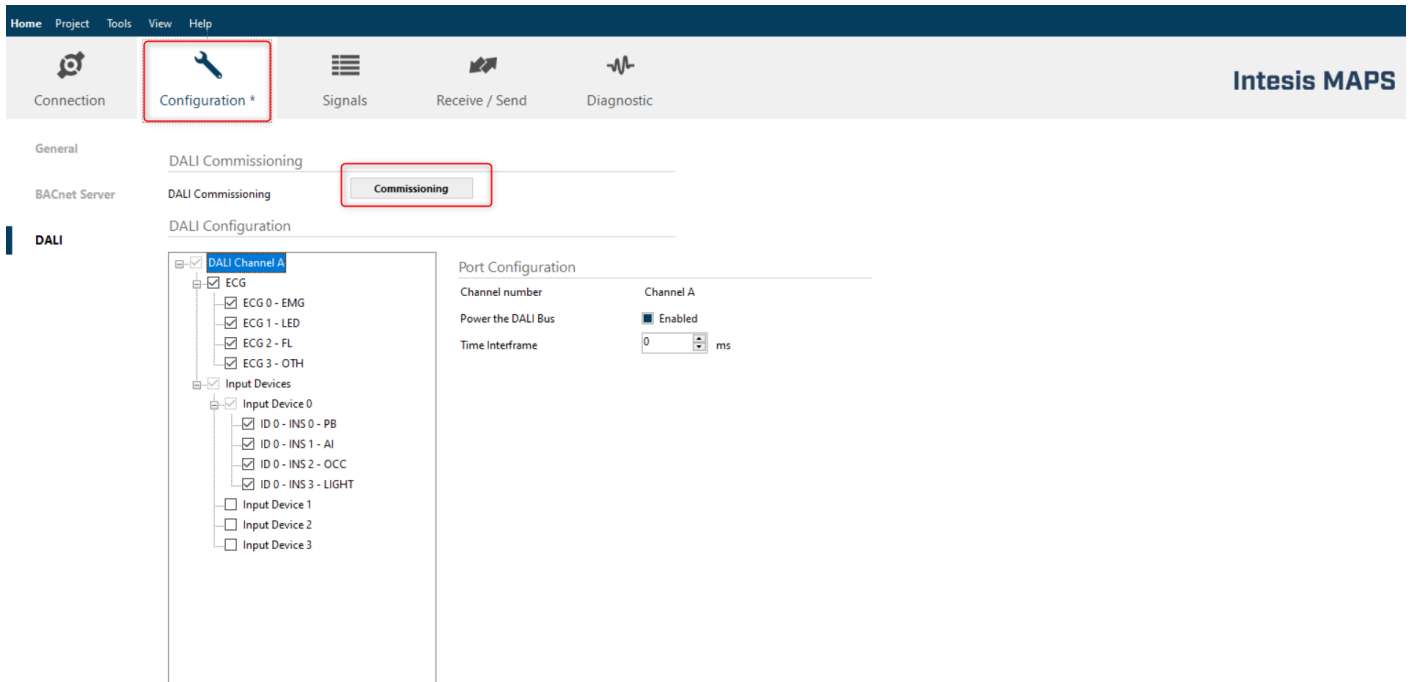

Figure A.7 DALI commissioning button

Commissioning window will appear:

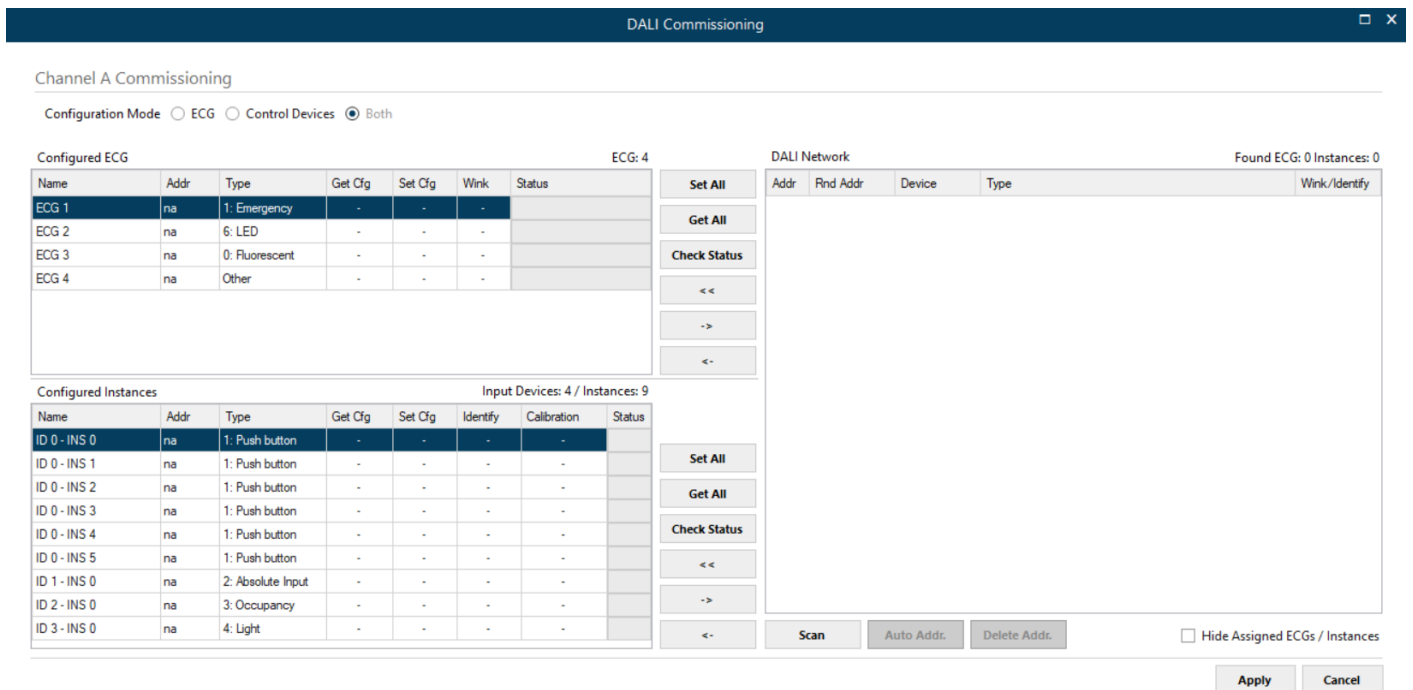

Figure A.8 DALI commissioning window

If devices have been added to the configuration (see previous section 'Device declaration in project') a list of ballasts will appear in Configured ECG and a list of instances will appear in Configured Instances.

There is also a 'DALI network' area that will show DALI scan results, empty by now.

In order to start a DALI network scan, select suitable DALI channel (if applicable) and then click on button 'Scan':

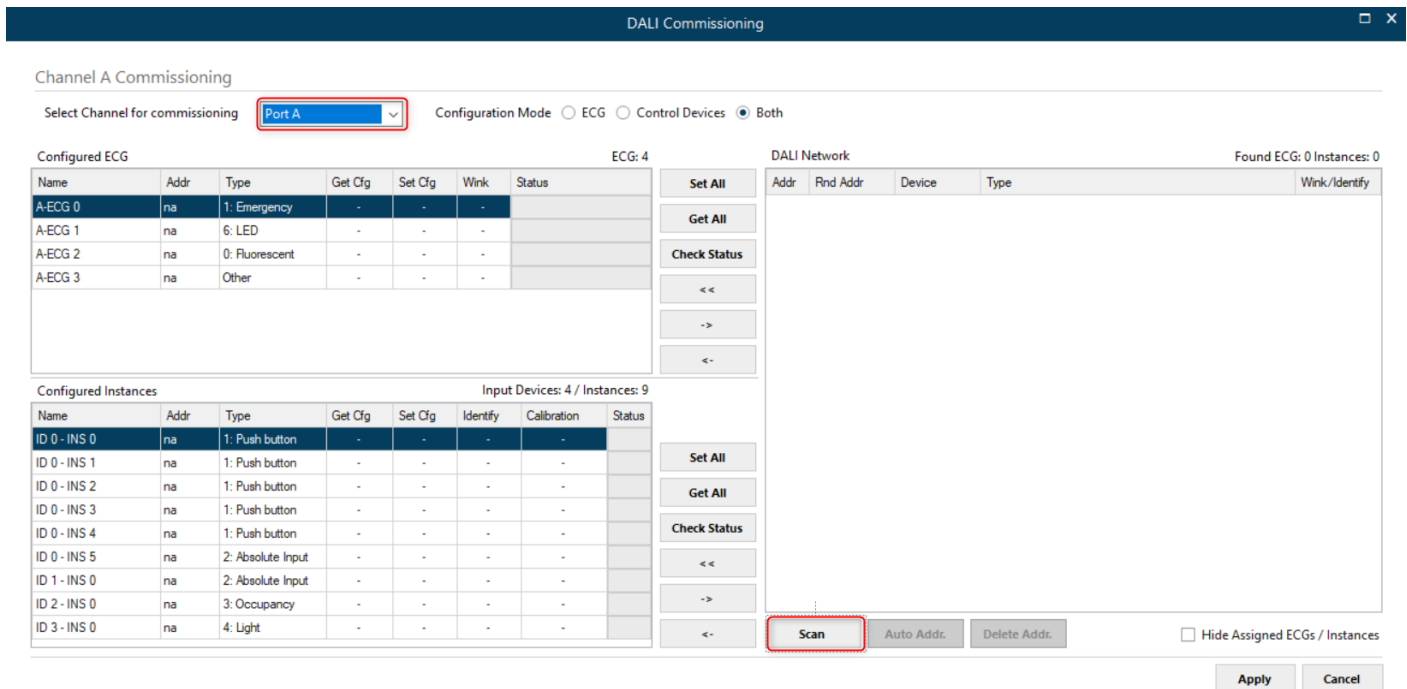

Figure A.9 Starting DALI scan process

Discovered devices will appear in the 'DALI Network' area as soon as they are scanned. Network scan might take from several seconds up to a few minutes, depending on number of devices to scan.

Field 'Addr' in list of 'DALI Network' will indicate 'na' if device has no associated group address (typical for new devices/factory settings) or a 0..63 value for its short address if device has already been given a short address.

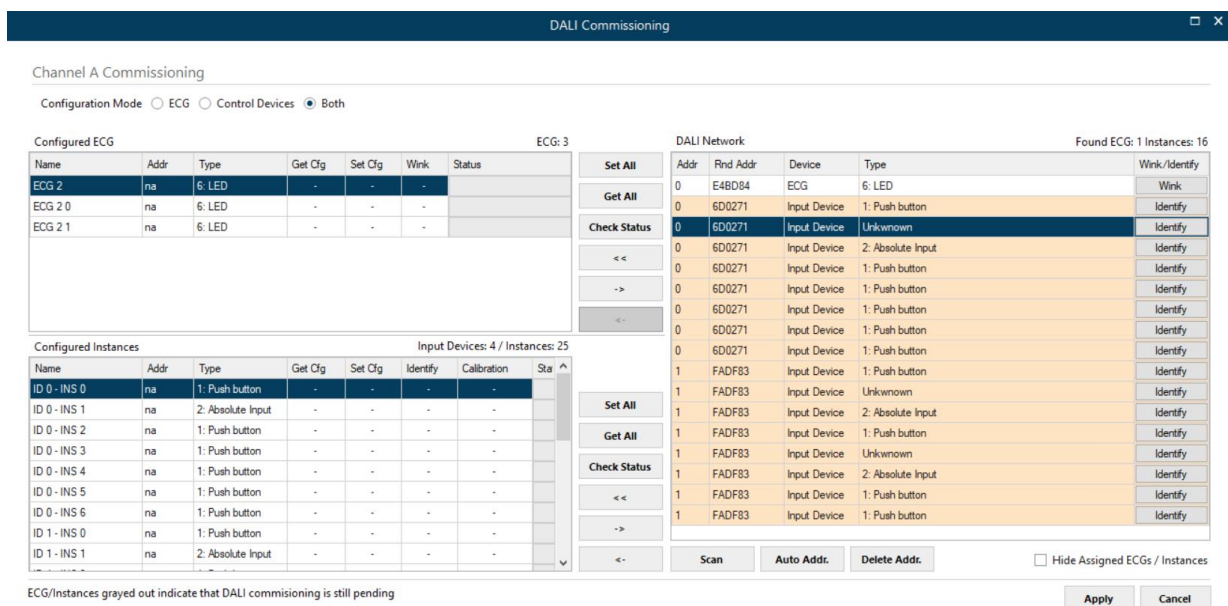

Figure A.10 Example of scan results

After scan is done, total number of found devices will be shown in 'DALI Network:' label. Note that type column will fill only if device has a short address assigned, if not, type cannot be read.

Next step is associating a short address between 0 to 63 to each found ballast. To do so, following options are possible:

1. Identify the device in the installation with the Wink button, and then double click in short address field of the device in DALI Network window and assign it an address 0..63.
2. Use the Auto Addr. Button to automatically assign a correlative address to each ballast.

Address of each ballast can be deleted at any time, using button Delete Addr. Multiple selection is possible (using Shift and Control keys together with mouse-clicks).

Once each device has a short address, 'Wink' functionality in "DALI Network" window is available for each one. Wink functionality sets the ballast at maximum and minimum level while it is active, allowing to identify the physical location of the ballast in the installation. After identifying it in the installation, change in short address might be desired.

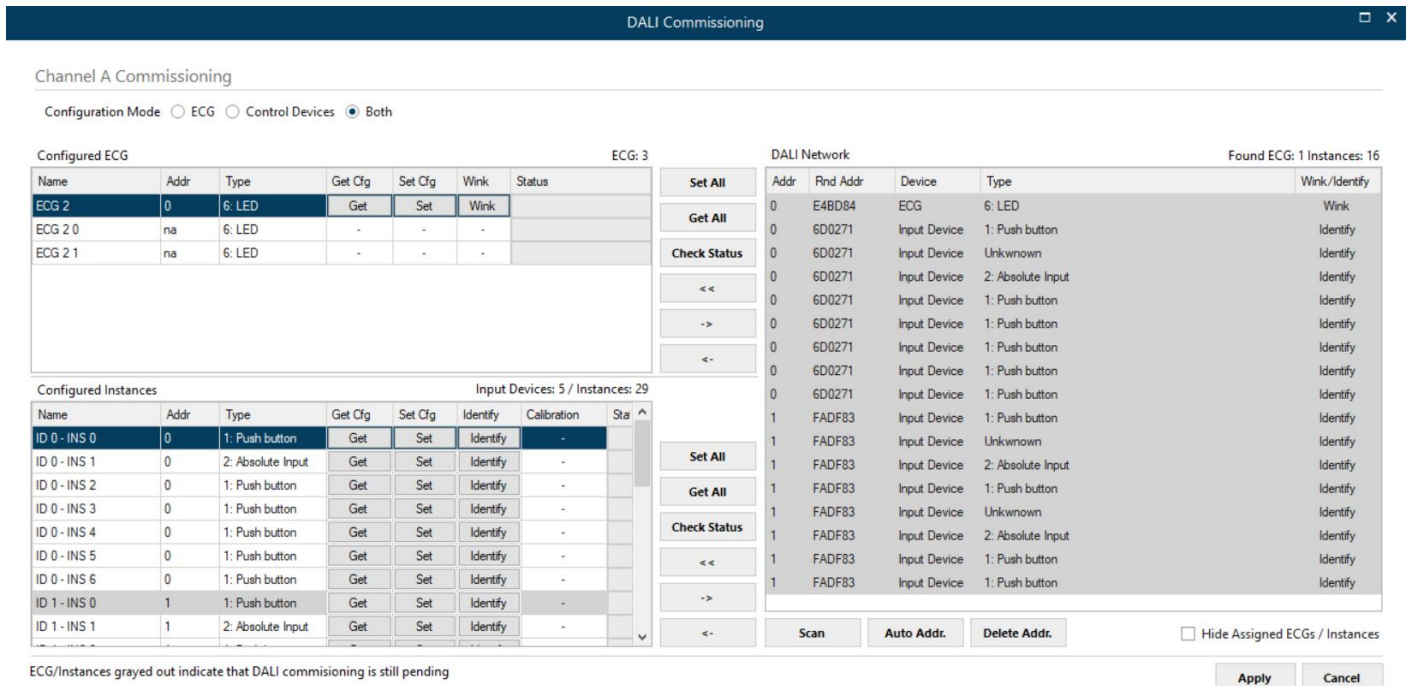

Figure A.11 identify a device-Wink

After address association, devices can be added in config. There is two ways for doing that:

- Button '<<': Selected ballast or ballasts in 'DALI Network' window will be added as a new ballast in 'Configured ECG' window. It allows multiple selection of ballasts from DALI Network window (using 'shift' or 'control' keys).
- Button '<-': Selected ballast in 'DALI Network' window will be associated to existing/configured ballast in 'Configured ECG' window.

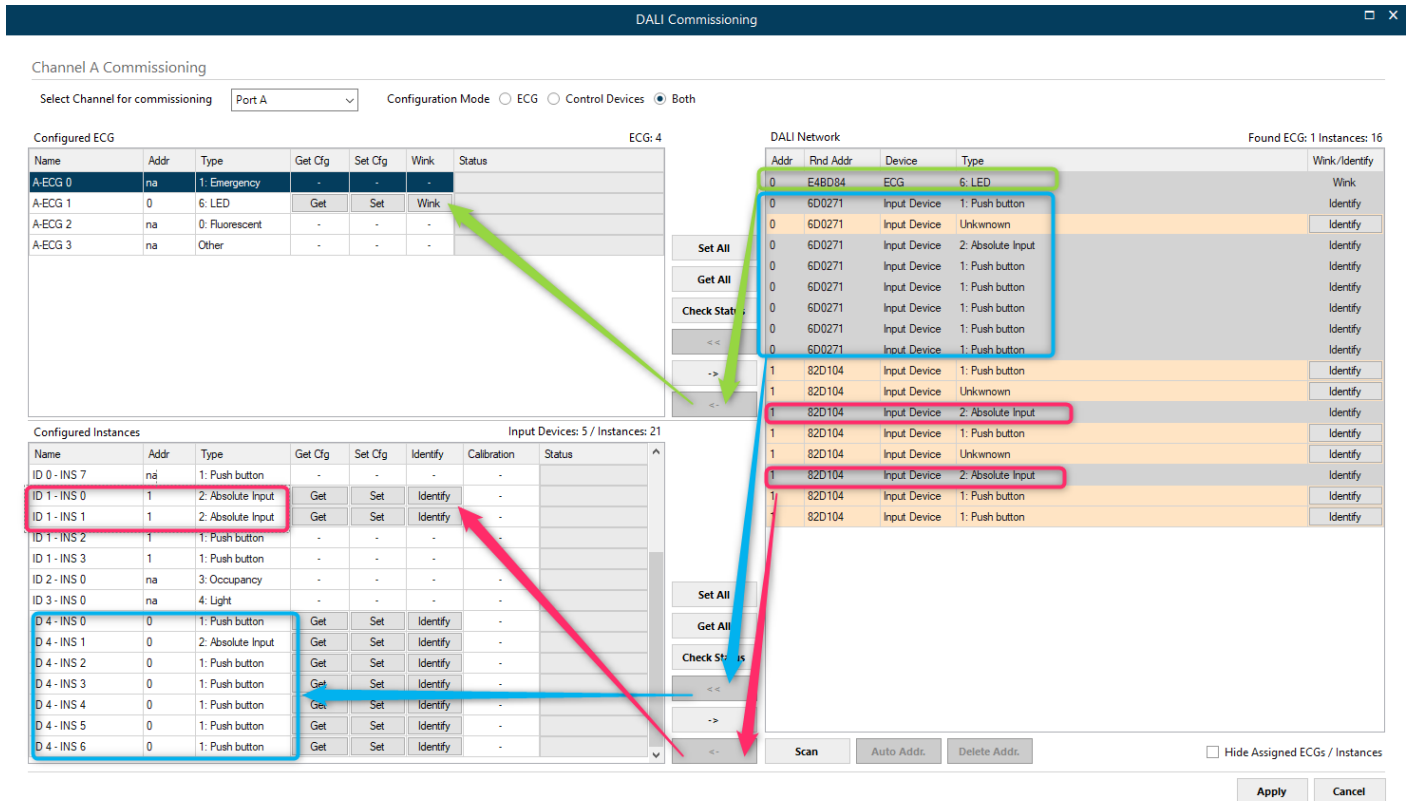

Figure A.12 Functionality of '<<' and '<-' buttons

In figure above we associate:

- the LED with short address 0 to the A-ECG 1 (in green) using the "<-<" button this would **assign the ECG** to the existing ECG on the MAPs configuration.
- the Push buttons of Input device with short address 0 (in blue) using the "<<<" button and **this would create** a new input device with these 7 instances, make sure you select all the instances of the same device at the same time as you cannot have instances of the same device associated with different devices on the MAPS configuration.
- and the absolute inputs of the input device with short address 1 (in red) using the "<-<" button this would **assign each selected instance** to the existing Input device/Instance on the MAPs configuration. Remember you cannot have instances of the same device associated with different devices on the MAPS configuration.

Figure above shows the result. Now configured ECG's and configured Instances contains actual ballasts and Input device instances in the installation, each with its own short address. At this point, it's possible to:

- **Remove the ballast or input device from configuration** (button '>>>'). This will move them back to 'DALI Network' area.
- **Wink the ballast to identify it in the installation** (button 'Wink', on each ECG).
- **Identify the Input device** ("Identify" button on each input device) the feedback would depend on each manufacturer some had a beep or LED that blinks, some may not have any means of feedback.
- **Get the ballast or input device configuration parameters** (button 'Get' on each ECG or input device, or 'Get All' on the side). Warning, getting the configuration of an ECG or Input device will overwrite all configured parameters in MAPS config for the devices (pre-set levels, group addressing, scenes, times, input device local management ...)
- **Set the ballast configuration parameters for each ECG or Input device** (button 'Set' on each ECG or input devices, or 'Set All' on the side).
- **Calibrate** (only for lighting sensors) to calibrate sensor measures with real lux measurement in the surface area.

Finally, pressing button 'Apply' will apply all changes to actual configuration in MAPS, and close the window.

Keep in mind that process done at window DALI commissioning changes configuration of parameters in DALI network, but it's still necessary to configure further parameters in Intesis and sending configuration file to Intesis using 'Send/Receive' tab of configuration section.

4 Input device programming options

As some input device type may require a quicker reaction time, we offer 2 options for the Push buttons and the Absolute input devices. One option is the sensor or Device would share the status or readings to the BMS (in this case over Modbus TCP) and then it would decide what actions need to be taken over the DALI lights or ECG (ex. Go to scene1, turn off, etc.)

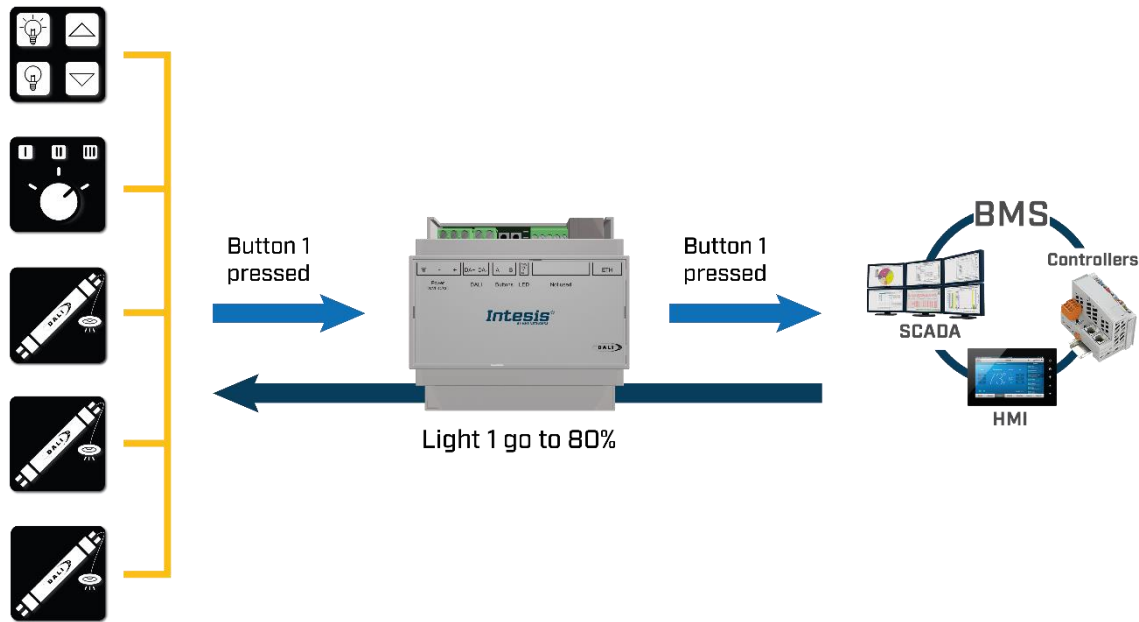

Figure A.13 Instance's Event Programming (action decided by the BMS)

The second option would be for the Gateway to directly act over the ECGs or DALI lights, which we can do through the Input device local Management menu. Please note this is not available for Occupancy and Light Sensors at this point.

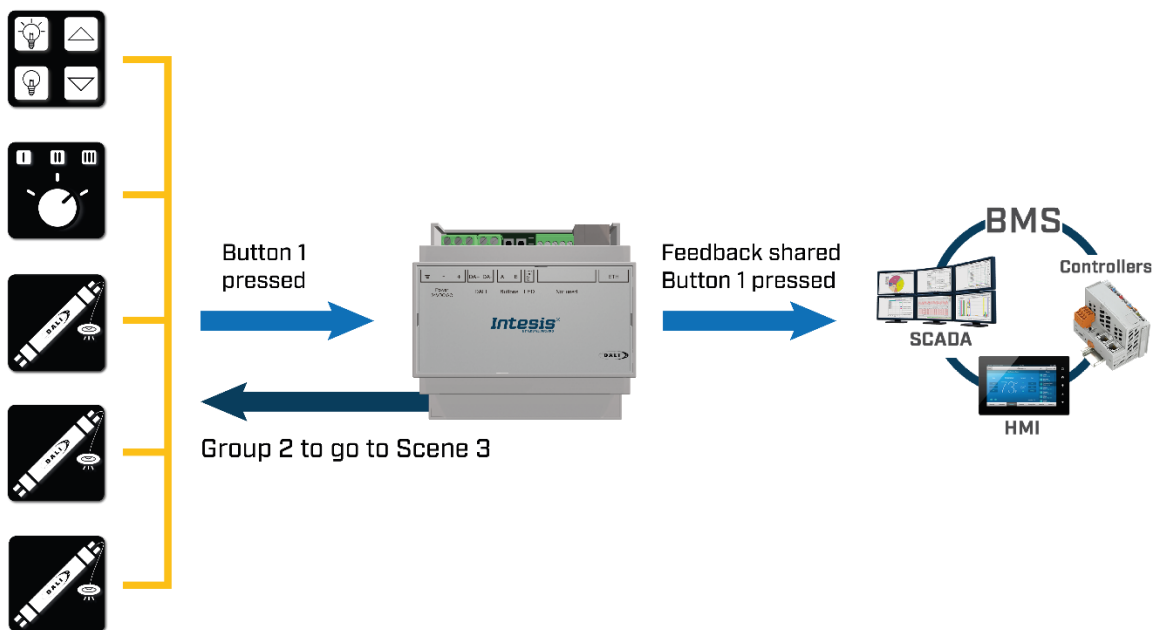

Figure A.14 Input device local management.

4.1 Instance's Event programming (action from the BMS)

In this scenario the gateway would be passively passing along the information regarding the status of the events from the input devices. For this configuration, you would have to:

4.1.1 Set the update method on the DALI bus

You can choose if poll the bus to get their info or enable the events in the devices so they can notify of a change, please note that "instance event" is recommended and more if the DALI bus is heavily loaded with devices (you are near the limits of the DALI bus) this is also a more efficient way to communicate with the Input devices.

The screenshot shows the Intesis MAPS software interface. The top navigation bar includes 'Home', 'Project', 'Tools', 'View', and 'Help'. Below this is a toolbar with icons for 'Connection', 'Configuration *', 'Signals', 'Receive / Send', and 'Diagnostic'. The 'Configuration *' icon is highlighted with a red box. The main content area is titled 'DALI Configuration' and is divided into sections: 'General', 'Modbus Slave', and 'DALI'. The 'DALI' section is active, showing a tree view of DALI channels and input devices. The 'Input Devices' folder is expanded, and the 'Instance update value mode' is set to 'Instance Event'. The 'Instance update value mode' section has three radio buttons: 'Instance Event' (selected), 'Instance Polling', and 'Both'. The 'Add Input Device(s)' section has a dropdown menu set to '1' and an 'Add' button. The 'Input Devices Local Configuration' section has an 'Edit' button.

A15. Instance update value mode

4.1.2 Set the Input device properties

Then you can go to the specific input device and its instance to set its properties, including the events that would report to the bus and how would it communicate, as mention before we recommend that you use event over polling. In this case make sure that you set "Events active" to "yes" and depending on the type of instance/device, you would also need to set the type of events require by your application, to enable the correct communication with the BMS.

In the case of the Push buttons for example, you can select between the Instant value or Event Type (ex. Double, long or short press, etc.) This functionality will enable the signals values for the BMS, to be shown in bitfields within the register correspondent to this instance, keeping the bitfield active for the time stipulated in the "BMS bit event time".

See the following image for details, if unsure please use the default values (they are always a good way to start) and then you can adjust as you see fit for your project.

The screenshot displays the Intesis MAPS software interface for configuring DALI input devices. The top navigation bar includes 'Home', 'Project', 'Tools', 'View', and 'Help'. Below this is a secondary navigation bar with icons for 'Connection', 'Configuration *', 'Signals', 'Receive / Send', and 'Diagnostic'. The main interface is divided into three sections: 'General', 'Modbus Slave', and 'DALI'. The 'DALI' section is active, showing 'DALI Commissioning' and 'DALI Configuration' tabs. The 'DALI Configuration' tab displays a tree view of DALI channels and input devices. The 'ID 0 - INS 0 - PB' item is highlighted with a red box. To the right, the configuration panel for this instance is shown, with several parameters highlighted in red boxes: 'Events Active ("Yes" recommended)' is set to 'Yes', 'BMS Signals Value' is set to 'Event type', and 'BMS bit event time' is set to '500 ms'. Other parameters include 'Instance Name' (ID 0 - INS 0), 'Instance Type' (1: Push Button), and various event enablement options.

A16. Input device properties

Remember to go to the DALI commissioning/Set all after finishing setting all the parameters or after each change so this can be transfer to the input device and ECGs. Please keep in mind that the “send” button in MAPS would only transfer the general parameters to the gateway but the DALI device properties, are only set trough the DALI commissioning.

4.2 Input device Local management (DALI local control)

This feature allows that the gateway acts over the DALI lights or ECGs directly, at the moment it is available in the DALI push buttons and Absolute input devices only, for Occupancy and Light sensors they would be programmed only as per point 4.1.

To use this option, you need to set the input devices to work on events, you can do this as described in 4.1.1 and 4.1.2

Once the events are set, then go to “Input Device Local Management” at the input devices level on the DALI configuration tree. There you can access to all available instances that will operate on this mode or you can access individually to each of them at the instance’s property menu.

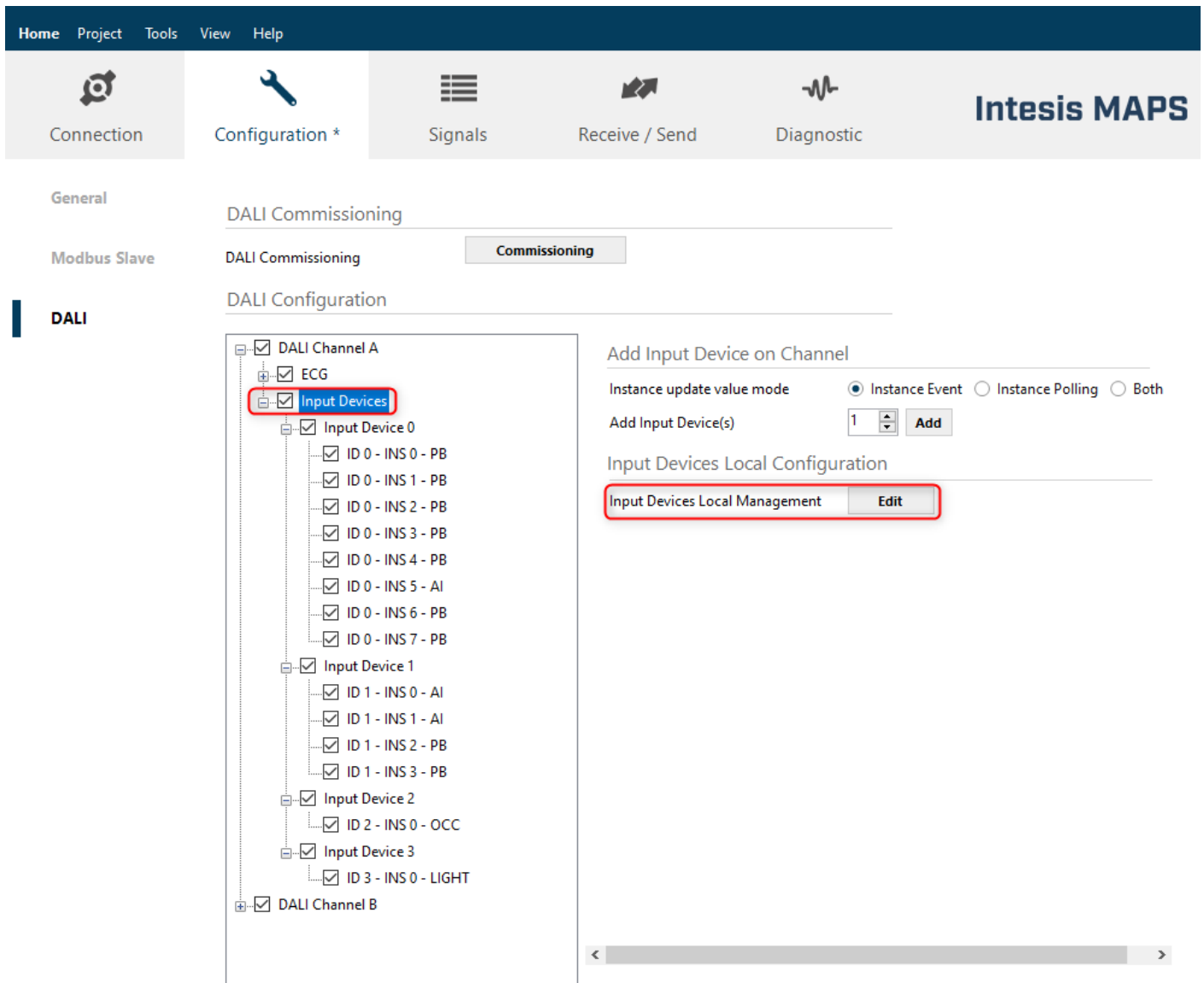

A17. Input device management

Once inside of this menu, you can choose what would need to happen in the DALI bus when an event from the Input device is detected.

Analogue input: the behaviour is set to slider that would adjust the light level according to feedback of the Input device, you can choose the target to be Broadcast to the entire DALI channel, a selected group, or a short address.

For the Push button, you can choose between Single action, Dimmer, Toggle or Multiaction. Each option would have its own properties but in general you can choose the type of event and its associated action and the target short address, group or broadcast for the entire bus.

These different modes have the following features:

- Single action:** Offers a simpler programming that fits well in a commercial application where the operation of the Push buttons needs to be intuitive. It would take effect with a short press, so it is the only event type required for this option. You can choose between go to level (0-100%) or go to scene and target the entire channel(broadcast), a single group or short address. (In the 2-channel dimmer you can choose which of the two channels).
- Dimmer:** This option regulates the light level up or down of the selected Target. The options are step up or down and you can select how quickly the light would go in between a step and the next, the steps are the ones defined in the DALI dimming curve. It requires the long press repeat event to be active and it would follow the time of the repeat time parameter.
- Toggle:** Is used to have 2 actions from a single button like One press would be ON and the other OFF, the options are by default ON/OFF or 2 different states where you can choose the type of action (Level, scene, dimmer, go to max, go to min, off, no action), the parameters of that action and the target (as in the single action)
- Multiaction:** This is intended for applications looking for more functionality like the Push and Dim, where you want to have several actions from a single button depending on the type of press (Short Press, Long Press or Double Press). You then select the kind of action for each type of press (Level, scene, dimmer, go to max, go to min, off, and no action) and the relevant parameter (if required) together with the target, this one is the same for all the actions on the button. You need to make sure that the type of event (short/long/double press and long press repeat if using dimmer) is set to active on the Push button instance parameters.

See the image below for further guidance.

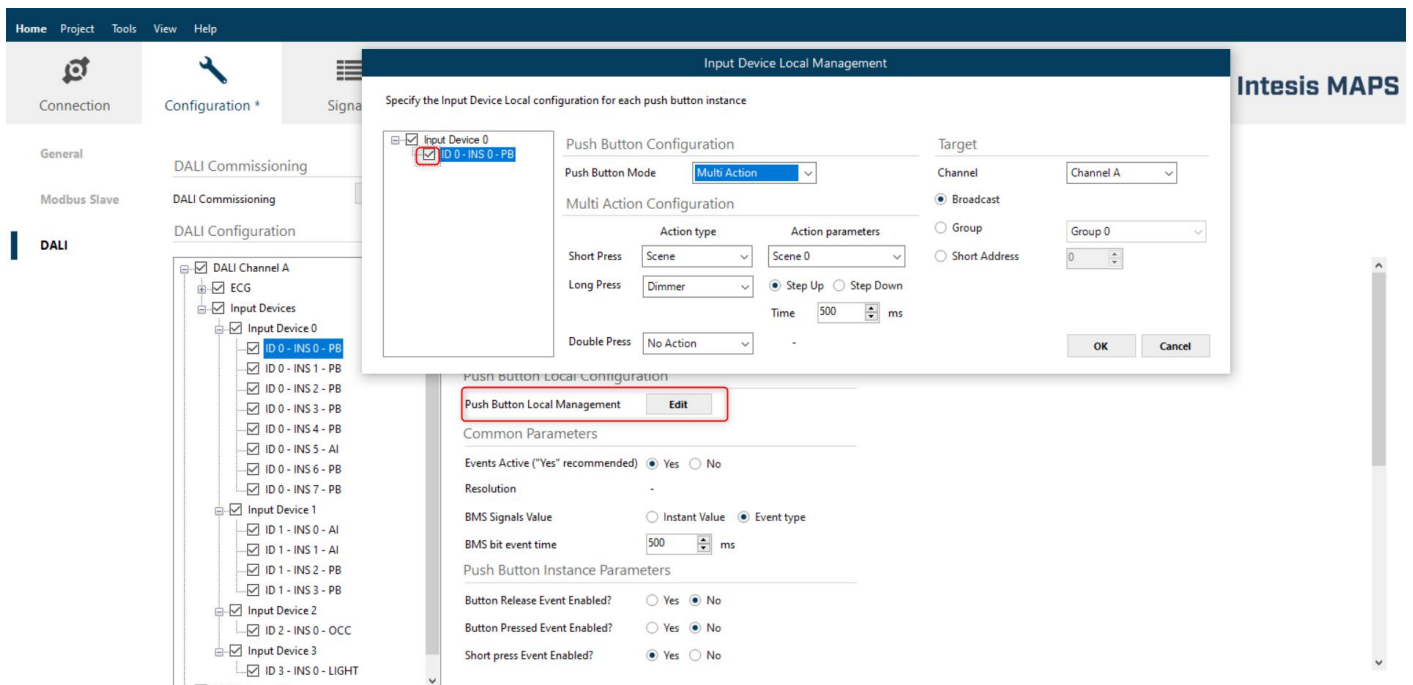

A18. Input device management options

4.3 Multi editing options

There are several multi editing options to help speed up the commissioning, especially for the Push buttons as they have several parameters. For example, you can copy the instance configuration to another of the same kind or copy the whole device as far as they have the same number and type of instances, this would include the input device local management configuration, or clone the input device if you have several of the same kind, the parameters setting, and configuration would also be copied.

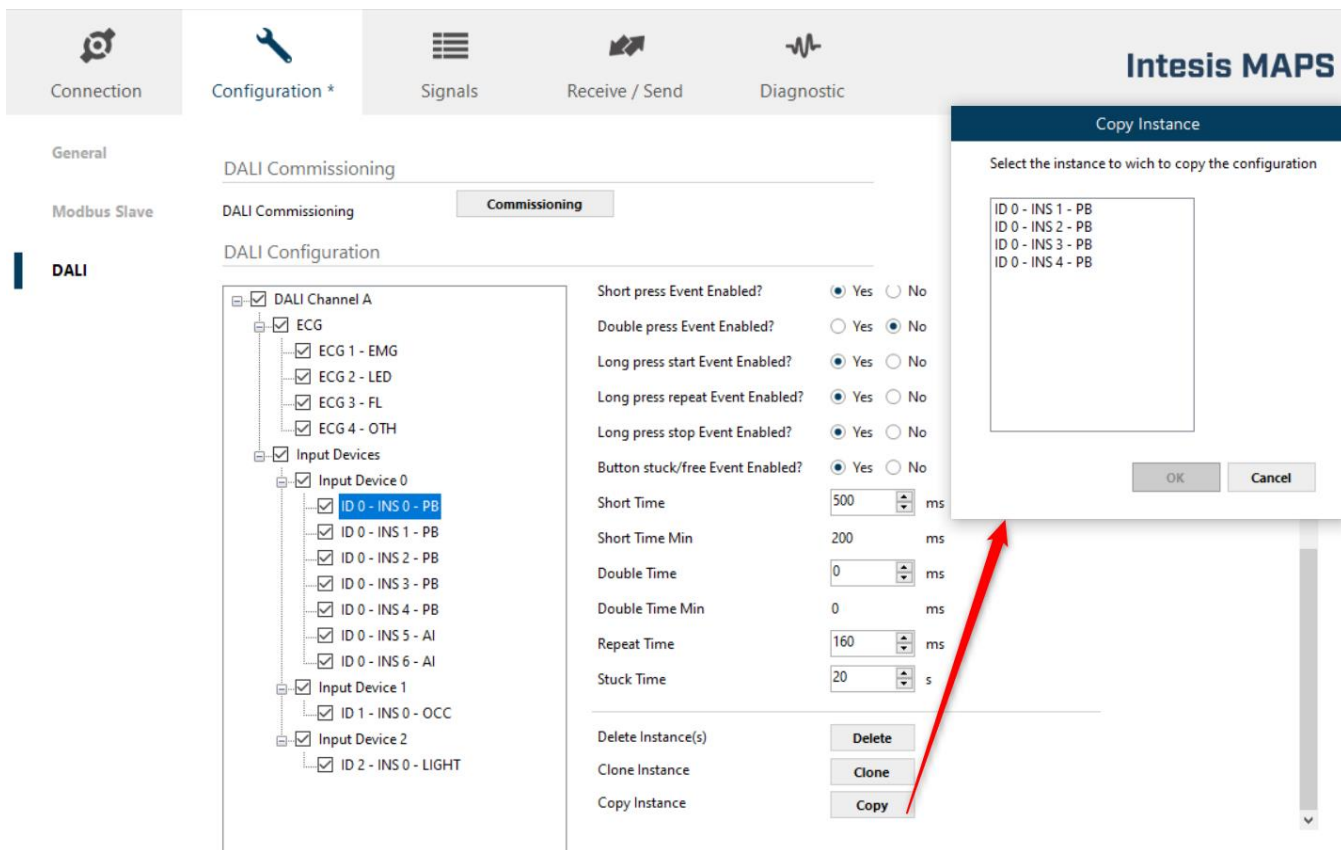

A19. Copy instance programming

Or select multiple instances at the time while holding the shift key and then adjust the parameters at the same time for all the instances selected.

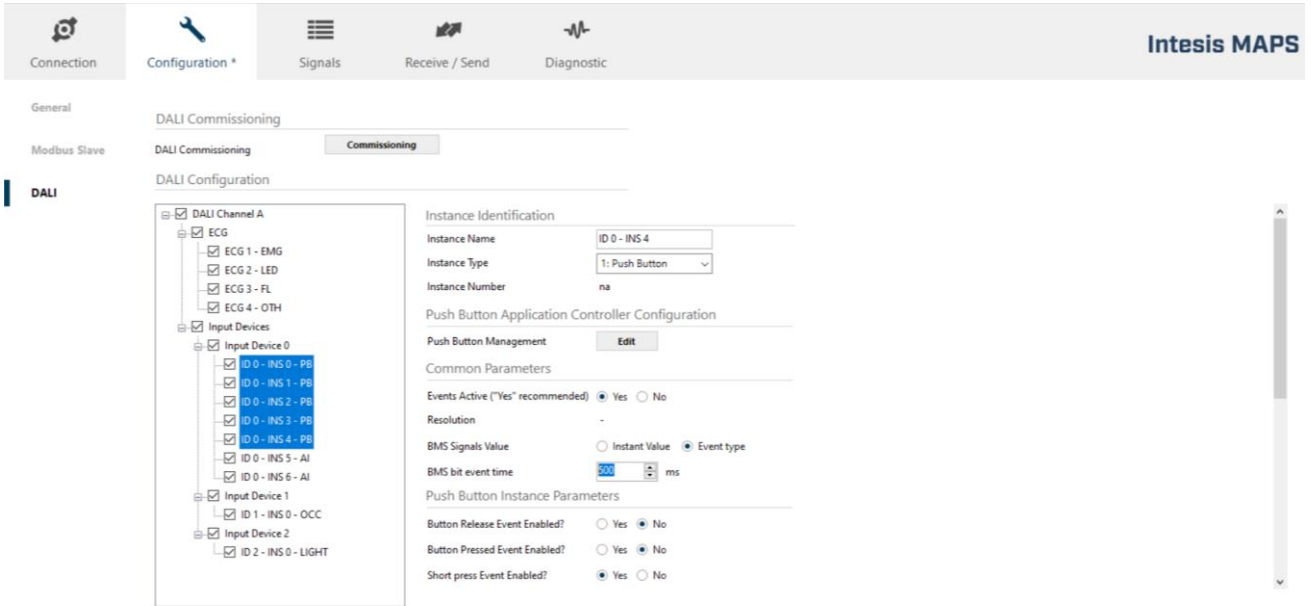

A20. Multiselect several instances at the time from the input device tree

Alternatively, you can also go to the input device management and using shift again select multiple instances at the same time and configure the actions that they need to take.

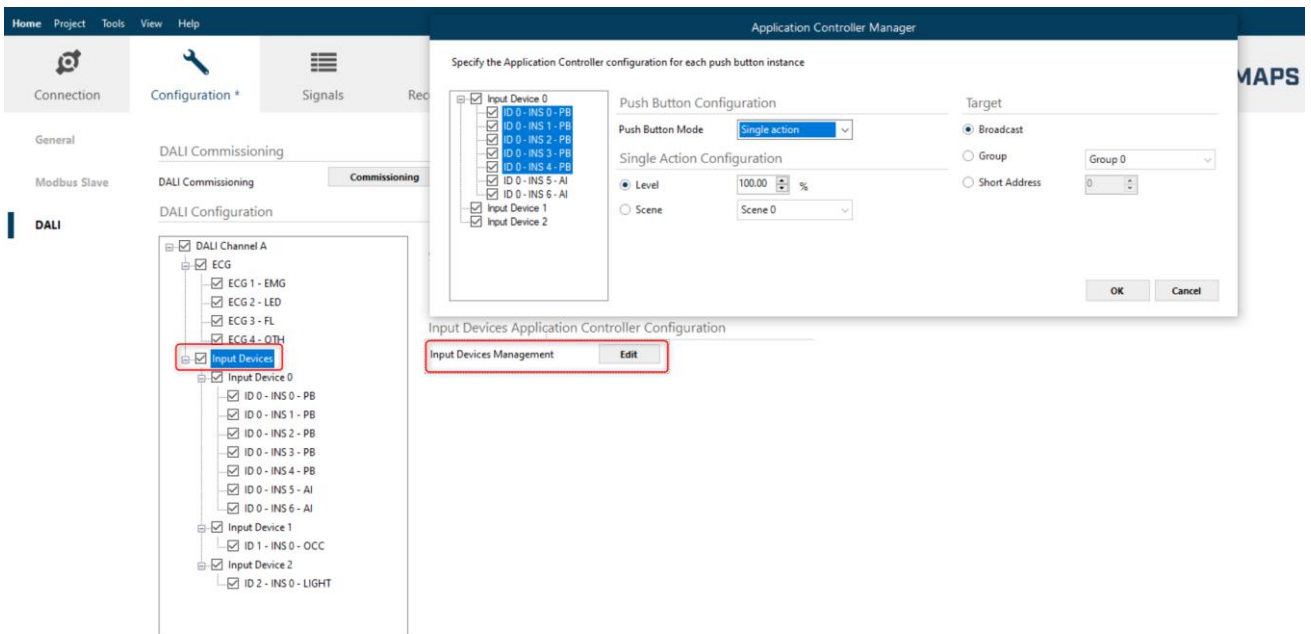

A21. Multiselect several instances at the time from the input device local management