



Lumento DX4

4-Channel Constant-Voltage PWM Dimmer in DIN Rail Format for DC LED Loads

ZDI-RGBDX4

Application programme version: [1.3]
User manual edition: [1.3]_a

CONTENTS

Contents	2
Document Updates	3
1 Introduction	4
1.1 Lumento DX4	4
1.2 Installation	5
1.3 RGB or RGBW Loads	7
2 Configuration	8
2.1 General	8
2.2 LED Lighting	10
2.2.1 Configuration	10
2.2.2 LED Lighting: Channel X	14
2.3 Inputs	45
2.3.1 Binary Inputs	45
2.3.2 Motion Detector	45
2.4 Master Light Control	46
2.5 Manual Control	49
Annex I. Communication Objects	53

DOCUMENT UPDATES

Version	Changes	Page(s)
[1.3]_a	Changes in the application program: <ul style="list-style-type: none">• Internal optimisation.	-
[1.2]_a	Changes in the application program: <ul style="list-style-type: none">• Optimisation of the inputs, master light, motion detector and Heartbeat modules.	-
[1.1]_a	Changes in the application program: <ul style="list-style-type: none">• Optimisation of the inputs, master light and motion detector modules.• Heartbeat functionality added.	-

1 INTRODUCTION

1.1 LUMENTO DX4

Lumento DX4 constitutes the Zennio solution in DIN-rail format for light regulation in constant-voltage DC LED luminaires. It offers a wide variety of functions:

- **4 output channels** (up to 6000 mA each) parameterisable for different output configurations, according to the LED module type:
 - **Individual channels:** allows an independent control over the different output channels.
 - **RGBW:** allows a joint control over one four-colour LED module. The output channel will be formed by the colour components (R, G, B and W) of a sole module, being all of them controlled jointly but with differentiated luminosity levels.
 - **RGB+W:** permits controlling a three-colour LED module, plus an independent white channel (i.e., **an RGB channel** plus an **individual channel** for the connection of a white LED module).
- **6 multi-purpose inputs**, each of them configurable as:
 - Binary inputs (i.e., pushbuttons, switches, sensors),
 - Motion detectors.
- **Master light control** for an easy, out-of-the-box control of a set of luminaires (or functionally equivalent devices) one of which acts as a general lamp and the others as secondary lamps.
- **Manual operation / supervision** of the four output channels through the on-board pushbuttons and LEDs.
- **Heartbeat** or periodical “still-alive” notification.

1.2 INSTALLATION

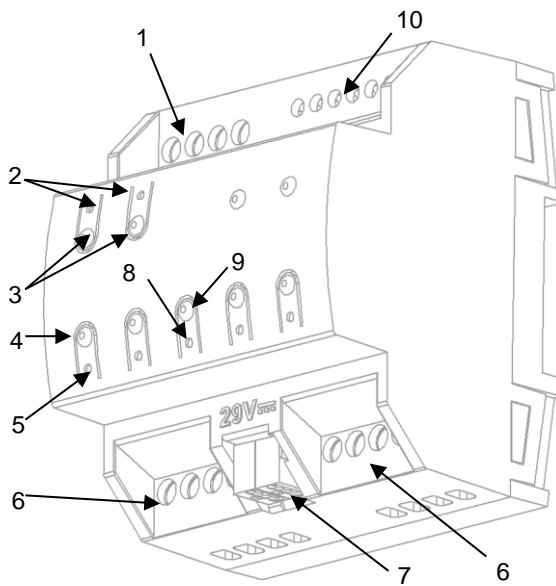

- 1 External power supply.
- 2 Colour shift status LED.
- 3 Colour shift control buttons.
- 4 Channel control button.
- 5 Channel status LED.
- 6 Output channels.
- 7 KNX connector.
- 8 Prog./Test LED
- 9 Prog./Test button.
- 10 Inputs.

Figure 1. Element diagram

The device connects to the KNX bus via the incorporated terminal (7), which provides the required power. On the other hand, an **additional power supply** (12 to 30 VDC) is required for powering the LEDs. The external power supply is connected to the device through the corresponding terminal (1). If the external power supply is higher than expected or the polarity of the connection is wrong, Lumento DX4 will report this **overvoltage** and **inverse polarity** through the Test indicator (8), which will turn blue.

Note: *only constant-voltage LED loads can be connected to Lumento DX4.*

Once the device is provided with bus power, both the physical address and the application programme can be downloaded, even if no external power is being provided. The **absence of external power** is notified by the Prog./Test LED (8) by flashing in blue.

The functionality of the main elements of the device is described below:

- **Prog./Test button:** a short press on this button (9) sets the device into the programming mode, making the associated indicator (8) turns red. If this button is held while plugging the device into the KNX bus, the device will enter the **safe mode**, making the indicator blink in red.

- **Prog./Test button:** a three-second press on this button (9) activates the Test Mode of the device, which allows verifying the correct connection of the LED modules.

Once the Test Mode is activated, **each of the channels can be switched on through the corresponding push buttons (4)**, which will also switch on the associated indicators (5). A colour scanning can also be performed by pressing any of the colour shift control buttons (3). The associated LED (2) will show the current colour.

To leave the Test Mode, just press the Test button again.

Note: *while the Test Mode is active, any order received from the KNX bus will be ignored until the deactivation of the mode.*

- **Inputs (10):** ports for the connection of the stripped cables from the external input elements, such as switches, motion detectors, etc.

To obtain detailed information about the technical features of Lumento DX4 as well as on security and on the installation process, please refer to the **Datasheet**, bundled within the original packaging of the device and also available at the Zennio website, <http://www.zennio.com>.

1.3 RGB OR RGBW LOADS

Lumento DX4 can regulate the **colour** and the **luminosity level** of an RGB or RGBW diode module.

Although both the colour and the luminosity are controlled by adjusting the level of the light emitted by the component colours (i.e., a change in the global luminosity is actually a joint adjustment of the luminosity of the component colours), the luminosity changes are performed by **maintaining the proportion between the components**, so in practice it is not the colour itself, but the light intensity, what is perceived to be changing.

LED modules are made of different colour components: Red, Green, Blue (RGB) and White (RGBW). The result of mixing the three first colours in the same proportion is, as well, the White colour, as shown in Figure 1. Other intermediate colours are obtained by combining the three main colours (R, G, B) or the four colours (R, G, B, W) in different proportions. The existence of a specific white component is normally intended to make these combinations easier and, generally, offers a higher fidelity when the white colour is shown.

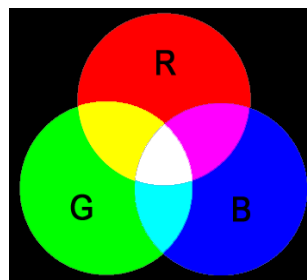

Figure 2. Combination of the Red, Green and Blue colour components

As stated, luminosity (or brightness) refers to the amount of light that the LED strip is emitting at a given time. The **general (or overall) brightness** of the set of diodes has been defined as the brightness of the **component that is emitting with the highest intensity**. On the other hand, the regulation of the general brightness is carried out so the visible colour is perceived as constant, by increasing or decreasing the brightness of the three colour components together, without losing their proportions.

Note: *the colour that is visually perceived (the colour actually obtained) may vary depending on the LED module and the colour diffuser being used.*

2 CONFIGURATION

2.1 GENERAL

After importing the corresponding database in ETS and adding the device into the topology of the desired project, the configuration process begins by entering the Parameters tab of the device.

ETS PARAMETERISATION

The tab tree on the left shows the “General” tab in the first place, which contains the following parameters.

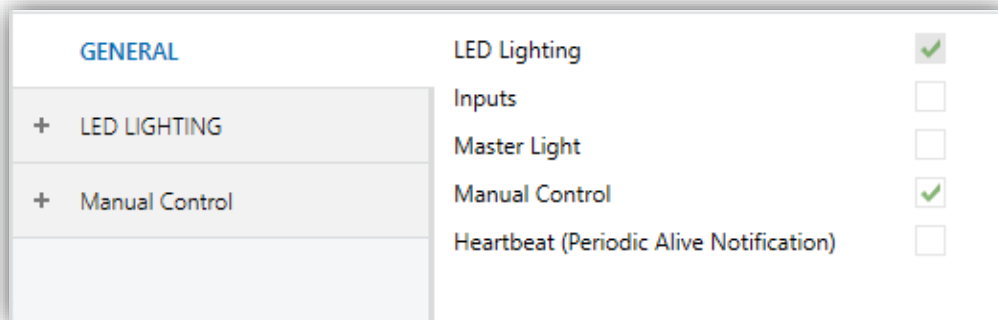
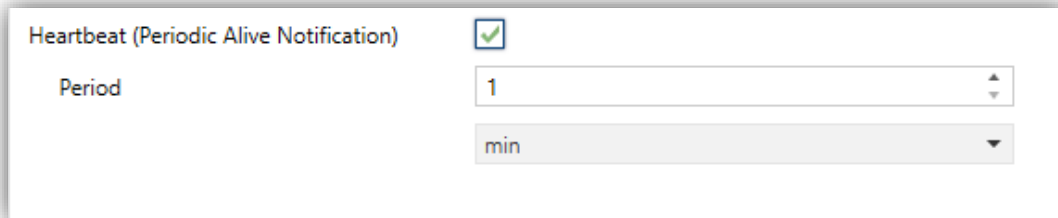

Figure 3. General.

- **LED Lighting** [[enabled](#)]¹: always enabled; the related parameters are contained in the “LED Ligthing” tab (see section 2.2).
- **Inputs** [[disabled/enabled](#)]: enables or disables the “Inputs” tab on the left menu (see section 2.3).
- **Master Light** [[disabled/enabled](#)]: enables or disables the “Master light control” tab on the left menu (see section 2.4).
- **Manual Control**: [[disabled/enabled](#)]: enables or disables the “Manual control” tab on the left menu (see section 2.5).

¹ The default values of each parameter will be highlighted in blue in this document, as follows: [[default/rest of options](#)].

- **Heartbeat (Periodical Alive Notification)** [*disabled/enabled*]: this parameter lets the integrator incorporate a one-bit object to the project (“**[Heartbeat] Object to Send ‘1’**”) that will be sent periodically with value “1” to notify that the device is still working (*still alive*).



Heartbeat (Periodic Alive Notification)	<input checked="" type="checkbox"/>
Period	1
	min

Figure 4. Heartbeat (Periodical Alive Notification).

Note: *The first sending after download or bus failure takes place with a delay of up to 255 seconds, to prevent bus overload. The following sendings match the period set.*

2.2 LED LIGHTING

2.2.1 CONFIGURATION

This block contains all the basic settings common to all the output channels: the **PWM frequency**, the **error objects** that report anomalous situations affecting the correct behavior of the device and the **operation mode** of the output channels.

ETS PARAMETERISATION

The **LED Lighting** tab contains the following parameters.

GENERAL	PWM Frequency	600 Hz
LED LIGHTING	Error Objects	<input type="checkbox"/>
CONFIGURATION	Outputs Configuration	4 Individual Channels
Manual Control	Channel 1	<input type="checkbox"/>
	Channel 2	<input type="checkbox"/>
	Channel 3	<input type="checkbox"/>
	Channel 4	<input type="checkbox"/>

Figure 5. LED Lighting.

- **PWM Frequency:** [[150 Hz](#)/[300 Hz](#)/[450 Hz](#)/[600 Hz](#)]: defines the regulation speed for the output voltage.
- **Error Objects** [[enabled](#)/[disabled](#)]: enables or disables the error notification objects (see section 2.2.1.1).
- **Outputs Configuration** [[4 Individual Channels](#)/[RGBW](#)/[RGB+W](#)]: sets the control type for the outputs. In case of opting for the first option, it will be possible to selectively enable or disable each of the individual channels through the specific checkboxes

Note: hereafter, the prefix “[Ch]” will be added to certain object names to refer to an output channel, although depending on the above parameter the actual name may begin with “[1]”, “[2]”, “[3]”, “[4]”, “[RGBW]”, “[RGB]”, “[W]”, “[R]”, “[G]”, or “[B]”.

With independence of the channel type, **three control objects per channel** will be included in the project topology after the channel activation:

- “[Ch] **Switch On/Off**”: one-bit object destined to perform a general switch-on (“1”) or switch-off (“0”) of the LED strip.
- “[Ch] **Relative Dimming**”: four-bit object destined to step-dimming the brightness (luminosity) level. Steps (upwards or downwards) of 1%, 3%, 6%, 12%, 25%, 50% and 100% are possible.
- “[Ch] **Absolute Dimming**”: one-byte object to specify a particular light level (by setting the target percentage value) over the general brightness level.

In the case of an RGB or RGB+W control, an additional parameter (**Independent Control Objects**) will be provided to allow enabling specific control objects per colour component in addition to the analogous, joint control objects.

Example

Assume that the outputs configuration is RGBW and the LED module shows the colour [25%, 50%, 0%, 3%] at a given time.

- *A regulation order of ‘70%’ through “[RGBW] **Absolute Dimming**” will set the component with the highest illumination level to 70%, while the others will vary proportionally ($70 / 50 = 1.4$). The output will become [35%, 70%, 0%, 4.2%].*
- *A regulation order through “[RGBW] **Relative Dimming**” to decrement the new light level by 25% will make the component with the highest level (G) decrease its value by 25% (becoming 45%), while the others will vary proportionally ($45 / 70 = 0.64$). Therefore, the output colour will become [22.5%, 45%, 0%, 2.7%].*

2.2.1.1 ERROR IDENTIFICATION

The error objects send automatic notifications to the KNX bus whenever the device detects abnormal situations, such as external power failures, overheating, short-circuits or overloads. When any of these is detected, the corresponding object (previously enabled) will be sent **with a value of “1” every thirty seconds**. Once the error is over, it will be sent once with a value of “0”.

2.2.1.1.1 Overheating

This situation takes place when the system temperature becomes **higher than 75°C**. In such case, the object “**Error: Overheating**” will be sent periodically, the light level of the output channels will be decreased to 30% and the Test indicator will start blinking in blue colour.

If the system **reaches 80°C**, the outputs will be turned off.

Once the temperature drops below 70°C, the value "0" will be sent through the error object, although for safety reasons the outputs will remain at their current level, until a new dimming order is received.

Note: *even if the error notification objects have not been enabled in parameters, the overheating protection remains **always enabled**.*

2.2.1.1.2 External Voltage error

This situation takes place when an unexpected power supply is detected, i.e., due to any of these events:

- Absence of power (disconnected source).
- Polarity inversion in the power supply.
- External voltage higher than allowed (30V).

At that moment, the object “**Error: External Voltage**” will be sent periodically. Once the situation is over, the outputs will recover their previous state.

2.2.1.1.3 Short-circuit or Overload

Once the system detects an overload situation, the object “**Error: Overload**” will be sent periodically and all the outputs will be automatically switched off. Next, the device will perform a per-output scan to determine whether the overload is due to a short circuit on any of them. In such case, the overload error will end and the short circuit error will be activated, sending the object “[Ch] **Error: ShortCircuit**” periodically while only the output under such situation is left switched off.

Notes:

- The detection of these errors is only possible in the course of a regulation. Moreover, they may not be detectable if the level of regulation is too low.
- When an overload error is received, a short circuit may also be occurring.

2.2.1.1.4 Error Notification

Under any of the above errors, even if the error notification remains disabled, a **visual notification** will notify it through the on-board LEDs (see section 1.2).

In case of error concurrence, only the one with the highest priority will be indicated. Table 1 shows these errors, ordered by priority.

ERROR	NOTIFICATION		+ Priority -																											
External Voltage Error	Prog./Test LED starts blinking in blue colour with a duration of 1s every 2s.	<table border="0"> <tr><td></td><td>P</td><td>T (s)</td></tr> <tr><td style="background-color: blue; width: 10px; height: 10px;"></td><td></td><td>1</td></tr> <tr><td style="background-color: white; width: 10px; height: 10px;"></td><td></td><td>2</td></tr> <tr><td style="background-color: blue; width: 10px; height: 10px;"></td><td></td><td>3</td></tr> <tr><td style="background-color: white; width: 10px; height: 10px;"></td><td></td><td>4</td></tr> <tr><td style="background-color: blue; width: 10px; height: 10px;"></td><td></td><td>5</td></tr> </table>			P	T (s)			1			2			3			4			5									
	P	T (s)																												
		1																												
		2																												
		3																												
		4																												
		5																												
Short-circuit or Overload	Channel status LED and Prog./Test LED flash in green and blue with a duration of 100ms every second.	<table border="0"> <tr><td></td><td>Cx</td><td>P</td><td>T (s)</td></tr> <tr><td style="background-color: green; width: 10px; height: 10px;"></td><td></td><td style="background-color: blue; width: 10px; height: 10px;"></td><td>0,1</td></tr> <tr><td style="background-color: white; width: 10px; height: 10px;"></td><td></td><td style="background-color: blue; width: 10px; height: 10px;"></td><td>1</td></tr> <tr><td style="background-color: green; width: 10px; height: 10px;"></td><td></td><td style="background-color: blue; width: 10px; height: 10px;"></td><td>1,1</td></tr> <tr><td style="background-color: white; width: 10px; height: 10px;"></td><td></td><td style="background-color: blue; width: 10px; height: 10px;"></td><td>2</td></tr> <tr><td style="background-color: green; width: 10px; height: 10px;"></td><td></td><td style="background-color: blue; width: 10px; height: 10px;"></td><td>2,1</td></tr> <tr><td style="background-color: white; width: 10px; height: 10px;"></td><td></td><td style="background-color: blue; width: 10px; height: 10px;"></td><td>3</td></tr> </table>		Cx	P	T (s)				0,1				1				1,1				2				2,1				3
	Cx	P	T (s)																											
			0,1																											
			1																											
			1,1																											
			2																											
			2,1																											
			3																											
Overheating	Prog./Test LED flashes in blue colour with a duration of 100ms every 2s.	<table border="0"> <tr><td></td><td>P</td><td>T (s)</td></tr> <tr><td style="background-color: blue; width: 10px; height: 10px;"></td><td></td><td>0,1</td></tr> <tr><td style="background-color: white; width: 10px; height: 10px;"></td><td></td><td>0,5</td></tr> <tr><td style="background-color: blue; width: 10px; height: 10px;"></td><td></td><td>0,6</td></tr> <tr><td style="background-color: white; width: 10px; height: 10px;"></td><td></td><td>1</td></tr> <tr><td style="background-color: blue; width: 10px; height: 10px;"></td><td></td><td>1,1</td></tr> <tr><td style="background-color: white; width: 10px; height: 10px;"></td><td></td><td>1,5</td></tr> </table>		P	T (s)			0,1			0,5			0,6			1			1,1			1,5							
	P	T (s)																												
		0,1																												
		0,5																												
		0,6																												
		1																												
		1,1																												
		1,5																												

Table 1. Visual Error Notification

2.2.2 LED LIGHTING: CHANNEL X

This tab contains the operating mode of the outputs:

- As independent, monochrome channels (up to four).
- As a joint RGBW channel.
- As a joint RGB channel, plus an independent W channel.

The functionality is analogous in all cases. The following sections describe this functionality, highlighting the details that differ from one case to another.

The main configuration of the output channel entails the following options:

- **Economical Mode:** defines the maximum dimming value (in percentage from 50% to 100%) that can be applied to the channels through a dimming order. If this parameter is set to a value other than 100%, a proportional reduction of the luminosity will be applied. However, Lumento DX4 will always send luminosity values between 0% and 100% to the KNX bus.

Example:

A value of 80% is assigned to this parameter. In such case, dimming orders for a luminosity of 100% will actually set a luminosity of 80%, although the status object will show a value of 100%. Analogously, orders for a luminosity of 50% will actually set it at 40%, although the status object will show 50%.

- **Dimming times:** the dimming time is the length of the transition between off (0%) and the maximum luminosity level (100%), and therefore determines the speed of the regulation. **Up to three different dimming times** can be defined and afterwards assigned to different functions and actions. Their values may also be changed through three communication objects (one per each dimming time).

Note: *since the dimming time refers to the transition from the minimum luminosity level (off) to the maximum luminosity level, enabling the economical mode will increase the dimming speed, as the maximum luminosity level becomes lower but must be reached in the same (parameterised) time.*

- **Independent Control Objects (RGBW / RGB+W only):** brings the option to control each of the colour components individually (in addition to the joint control) analogously as in the individual channel output configuration.
- **White Colour Only On W Channel (RGBW only):** sets whether the white colour should be obtained only by using the W channel (remaining the other channels off) or also by combining the R, G and B channels.

In addition to the options concerning LED lighting, the Lumento DX4 offers some more additional features, which are disabled in parameters by default: **status objects, characteristic curve, color selection objects (RGBW / RGB+W only), custom on/off switches, automatic switch-off, timed or delayed, scenes and sequences, lock control and custom initialization.**

ETS PARAMETERISATION

The main tab of a specific channel contains the parameters shown in Figure 6.

GENERAL	Economical Mode <input type="checkbox"/>
LED LIGHTING	
CONFIGURATION	
LED Lighting: Channel RGBW	
Switch On/Off	
Dimming	
Manual Control	
	DIMMING TIMES (from 0% to Maximum)
	Dimming Time 1 <input type="text" value="5"/> <input type="text" value="s"/>
	Dimming Time 2 <input type="text" value="10"/> <input type="text" value="s"/>
	Dimming Time 3 <input type="text" value="15"/> <input type="text" value="s"/>
	Dimming Time Objects <input type="checkbox"/>
	Independent Control Objects <input type="checkbox"/>
	White Color Only On W Channel <input type="checkbox"/>
	FUNCTIONS
	Status Objects <input type="checkbox"/>
	Characteristic Curve <input type="checkbox"/>
	Color Selection Objects <input type="checkbox"/>
	Custom On/Off <input type="checkbox"/>
	Auto Off <input type="checkbox"/>
	Timers <input type="checkbox"/>
	Scenes/Sequences <input type="checkbox"/>
	Lock <input type="checkbox"/>
	Custom Initialization <input type="checkbox"/>

Figure 6. Configuration.

- **Economical Mode** [*enabled/disabled*]: when enabled, a new parameter shows up:
 - **Maximum Light Level** [*50...100*][%]: sets the maximum percentage dimming value that the channel can reach.

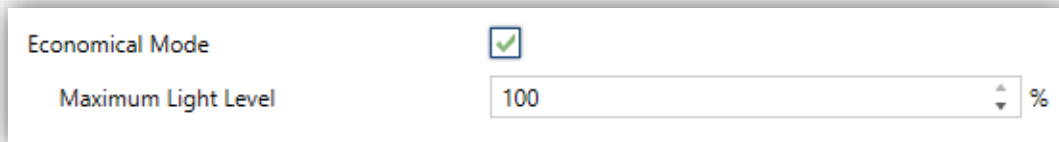

Figure 7. Economical Mode.

- **Dimming Times** [*1...100*][*ds/s/min*]: length of the transition between the minimum and maximum luminosity levels. Three alternative dimming times may be parameterised.
- **Dimming Time Objects** [*enabled/disabled*]: enables or disables three two-byte objects, named “[Ch] Dimming Time *n*”, which allow changing the dimming times parameterised in the range 1 to 6000 seconds.
- **Independent Control Objects** [*enabled/disabled*] (*RGBW / RGB+W only*): enables or disables additional communication objects per colour components, analogous to those in an individual channel control. These objects are:
 - “[X] Switch On/Off”: one-bit object for a switch-on (“1”) or a switch-off (“0”) of component X.
 - “[X] Relative dimming”: four-bit object destined to step-dimming the luminosity level of component X. Steps upwards or downwards (of 1%, 3%, 6%, 12%, 25%, 50% or 100%) are possible.
 - “[X] Absolute dimming”: one-byte object destined to specify a particular light level (by setting the target percentage value) over the brightness level of component X.

Note: [X] refers to [R], [G], [B] or [W].

- **White Colour Only On W Channel** [*enabled/disabled*] (*RGBW only*): enables or disables the representation of the white color using only the W channel.

● Functions:

- **Status Objects** [*enabled/disabled*]: enables or disables the “Status Objects” tab on the left menu (see section 2.2.2.3).
- **Characteristic Curve** [*enabled/disabled*]: enables or disables the “Characteristic Curve” tab on the left menu (see section 2.2.2.4).
- **Color Selection Objects** [*enabled/disabled*] (RGBW / RGB+W only): enables or disables the selection and control of the resulting color, either through a direct selection, or by assigning values to the color components, or through a color scan sequence (see section 2.2.2.5).
- **Custom On/Off** [*enabled/disabled*]: enables or disables the Custom On/Off” tab on the left menu (see section 2.2.2.6).
- **Auto Off** [*enabled/disabled*]: enables or disables the “Auto Off” tab on the left menu (see section 2.2.2.7).
- **Timers** [*enabled/disabled*]: enables or disables the “Timers” tab on the left menu (see section 2.2.2.8).
- **Scenes / Sequences** [*enabled/disabled*]: enables or disables the “Scene/Sequences” tab on the left menu (see section 2.2.2.9).
- **Lock** [*enabled/disabled*]: enables or disables the “Lock” tab on the left menu (see section 2.2.2.10).
- **Custom initialization** [*enabled/disabled*]: enables or disables the “Custom initialization” tab on the left menu (see section 2.2.2.11).

2.2.2.1 SWITCH ON/OFF

Lumento DX4 lets configuring the general On/Off switch control, so that these actions are performed **immediately** or through a **smooth regulation** (according to one of the three configurable dimming times; see section 2.2.2).

Furthermore, it is possible to specify the illumination level that the channel will adopt when a general switch-on order is executed: either a value defined in parameters or the value that was active prior to the switch off (i.e., a memory switch-on).

Note that, in RGB / RGBW channels, **the colour will always be preserved** when the channel is switched off and afterwards on. Configuring a specific illumination level only affects to the light intensity, not to the ratio of the different colour components.

ETS PARAMETERISATION

The Switch On/Off window contains the following parameters.

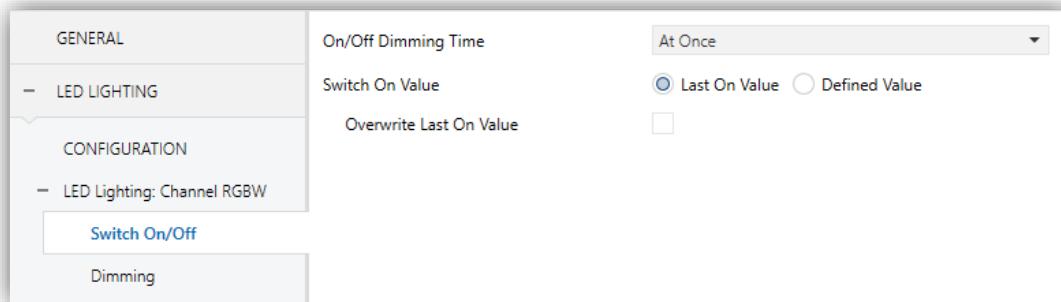

Figure 8. Switch On/Off

- **On/Off Dimming Time** [[At Once](#) / [Dimming Time 1](#) / [Dimming Time 2](#) / [Dimming Time 3](#)]: set the response time for the On/Off control command (see section 2.2.2).
- **Switch On Value** [[Last On Value](#) / [Defined Value](#)]: allows selecting the general illumination level that will be adopted by the channel when the value “1” is received through “[Ch] Switch On/Off”:
 - **Last On Value**: when enabled, a new parameter shows up.
 - **Overwrite Last On Value** [[enabled/disabled](#)]: determines whether a second switch-on order should set the maximum illumination level and therefore overwrite the last memorised value.
 - **Defined Value**: when enabled, a new parameter shows up:
 - **Defined Value** [[0...100](#)][%].

Example:

“Last On Value” is selected with an RGB channel configuration.

- *The LED module is on, and in orange colour (100%, 20%, 0%). If '1' is received through “[RGB] Switch On/Off”, it will remain in the same state.*
- *The channel is switched off by sending one '0' through “[RGB] Switch On/Off”. If afterwards the value '1' is received through the same object, the channel will show orange colour again.*
- *A ‘Decrement by 50%’ relative dimming order is sent through “[RGB] Relative Dimming”, so the channel switches to (50%, 10%, 0%). Afterwards, an identical order is sent again, causing the switch-off of the channel. If it is eventually switched on through “[RGB] Switch On/Off”, the orange colour will be restored at level (50%, 10%, 0%).*

On the contrary, under a “Defined Value” configuration (with value 80%):

- *The channel module is on, and in orange colour (100%, 20%, 0%).*
- *A “Decrement by 50%” relative regulation order is sent through “[RGB] Relative Dimming”. The colour ratio is preserved, reducing the illumination level to (50%, 10%, 0%). Afterwards, the channel is switched off.*
- *When a '1' is received through “[RGB] Switch On/Off”, the illumination level is set to 80% but preserving the colour ratio, which results in (80%, 16%, 0%).*

2.2.2.2 DIMMING

Lumento DX4 provides two general dimming modes besides the general On/Off Switch:

- **Relative Dimming:** modifies the luminosity level through orders to increment or decrement it by fixed percentages (“1.6%”, “3.1%”, “6.3%”, “12.5%”, “25%”, “50%” or “100%”), which will be added to or subtracted from the current luminosity level of the channel. A **four-bit object** is provided for the reception of the relative dimming orders.
- **Absolute dimming:** modifies the luminosity level through orders that specify the desired target value, regardless of the current value of the channel. A **one-byte object** is provided for the reception of the absolute dimming orders.

Both regulation modes will be subject to the **maximum and minimum illumination levels specified in parameters** (which may be helpful depending on the response of the LED loads). It is also possible to configure **which of the three already-defined dimming times should apply to perform the entire transition** between 0% and 100% (i.e., the dimming speed), unless an immediate transition is preferred.

ETS PARAMETERISATION

The “Dimming” window, available from the start, contains the following parameters:

GENERAL	RELATIVE DIMMING (4-Bit)
LED LIGHTING	Relative Dimming Time: Dimming Time 1
CONFIGURATION	Maximum Dimming Value: 100
LED Lighting: Channel RGBW	Minimum Dimming Value: 0
Switch On/Off	Allow Switching On via Relative Dimming: <input checked="" type="checkbox"/>
Dimming	Allow Switching Off via Relative Dimming: <input checked="" type="checkbox"/>
Manual Control	ABSOLUTE DIMMING (1-Byte)
	Absolute Dimming Time: Dimming Time 2
	Maximum Dimming Value: 100
	Minimum Dimming Value: 0

Figure 9. Dimming

- **RELATIVE DIMMING (4 bits):** this section allows setting up the configuration of the relative dimming function and the “[Ch] Relative Dimming” four-bit object. The value of the object will be interpreted as the desired step (brighter or darker), according to the KNX standard. Values “0” and “8” interrupt the current regulation.
 - **Relative Dimming Time** [*At Once / Dimming Time 1 / Dimming Time 2 / Dimming Time 3*]: set the response time for the relative dimming command (see section 2.2.2).
 - **Maximum Dimming Value** [*51...100*][%]: sets the maximum illumination percentage that will be allowed in the channel. If an order implying an illumination level beyond this limit is received, the channel will adopt this maximum level, as the status object will reflect.
 - **Minimum Dimming Value** [*0...50*][%]: sets the minimum illumination percentage that will be allowed in the channel. If an order implying an

illumination level below this limit is received, the channel will adopt this minimum level (unless “**Allow Switching Off via Relative Dimming**” is **active**; see below), as the status object will reflect.

- **Allow Switching On via Relative Dimming** [*disabled/enabled*]: sets whether a channel that is found to be off should be switched on in case a relative increase order is received, or whether the order should be ignored.
 - **Allow Switching Off via Relative Dimming** [*disabled/enabled*]: sets whether the device should switch off the channel in case the channel is found to be on and a light decrease order is received implying a luminosity value of 0% (or of any value under the minimum dimming value parameterised), or simply ignore the order.
- **ABSOLUTE DIMMING (1 byte)**: this section allows setting up the configuration of the absolute dimming function and the **one-byte** object “[Ch] **Absolute Dimming**”. All parameters are analogous to those for the relative dimming.

2.2.2.3 STATUS OBJECTS

Lumento DX4 provides different objects that report the current illumination state of the output channel:

- **A one-bit On/Off object**,
- **A one-byte object**, which indicates the illumination level (in percentage),
- **A three-byte object** (in the case of an RGBW or RGB+W configuration), which indicates the illumination level (in percentage) of the three main colour components.
- **Independent status objects** (in the case of an RGBW or RGB+W configuration), i.e.:
 - A one-bit object (On/Off) per colour component.
 - A percentage one-byte object per colour component.

ETS PARAMETERISATION

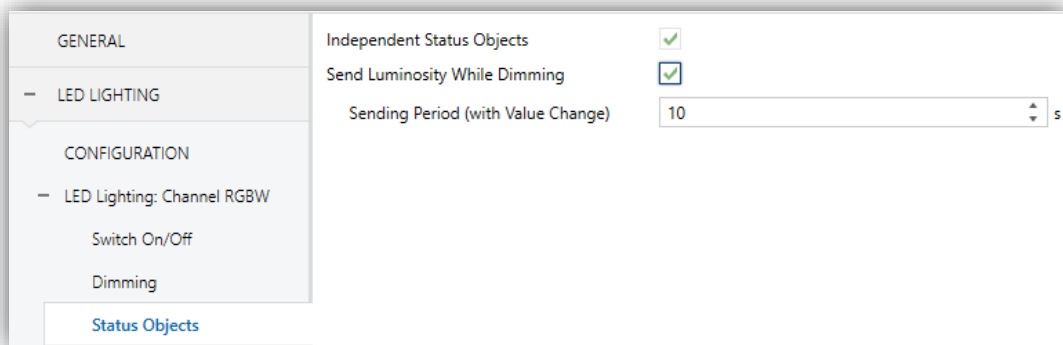

Figure 10. Status Objects

The activation of this function brings in a new tab to the channel configuration within the side menu, as well as the following **communication objects**:

- “[Ch] On/Off (Status)”: one-bit object that indicates if the channel is switched off (“0”) or on (“1”).
- “[Ch] Dimming Value (Status)”: one-byte object that represents the illumination percentage of the channel (0% to 100%).

Note: under *RGBW* and *RGB+W* output configurations, this general illumination level will always refer to that of the colour component (R, G, B or W) with the maximum illumination level at the moment.

- “[Ch] RGB Dimming Values (Status)” (*RGBW / RGB+W* only): three-byte object which indicates the illumination levels of the three main colour components. Each byte represents, respectively, the R, G and B components.

Regarding the parameters contained in the Status Objects tab:

- **Independent Status Objects** [*enabled/disabled*] (*RGBW / RGB+W* only): Its activation will enable two additional status objects for each single channel (R, G, B, W):
 - “[X] On/Off (Status)”: one-bit object that indicates if the component is switched off (“0”) or on (“1”).

- “[X] Dimming Value (Status)”: one-byte object that represents the illumination percentage of the component (0% to 100%).
- **Send Luminosity While Dimming** [*enabled/disabled*]: makes the “[Ch] Dimming Value (Status)” object be sent periodically to the bus throughout the dimming process. If enabled, also the following parameter will appear:
 - **Sending Period (with Value Change)** [*1...10...100*][s]: defines the sending cycle time of the status object.

Notes:

- *The status object is sent unless its value has not changed since the previous sending.*
- *Under an RGBW / RGB+W configuration, “[Ch] RGB Dimming Values (Status)” will be sent as well together with the “[X] Dimming Value (Status)” individual status objects, if enabled.*
- *As soon as the channel illumination level is greater than 0%, the “[Ch] On/Off (Status)” object will be sent with the value “1”, while the value “0” will be sent as soon as it becomes 0% again. The per-component “[X] On/Off (Status)” objects, if enabled, will behave analogously.*

2.2.2.4 CHARACTERISTIC CURVE

By default, all control values received are directly applied to the loads (through a PWM signal) as shown in Figure 11.

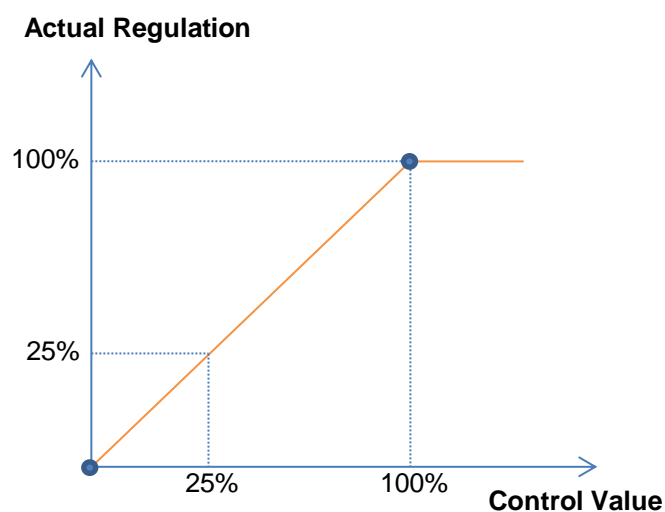

Figure 11. Default Control Curve.

For a more complex control, the device can implement a characteristic curve, defined through **four custom control points**, i.e., four pairs of values of the form (x, y). This lets the definition of custom curves, such as:

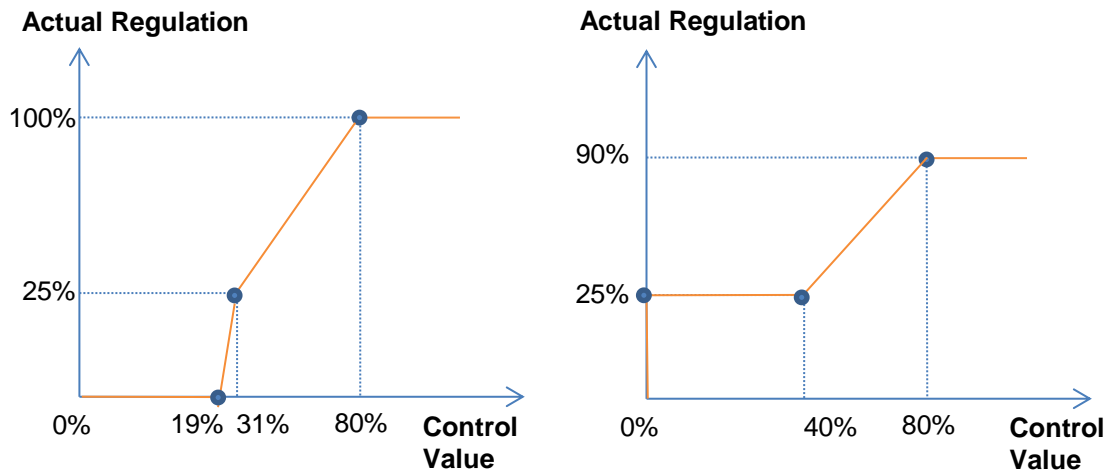

Figure 12. Custom Control Curves.

In case the first and last points do not correspond (respectively) to values 0% and 100%, the characteristic curve will be defined as follows (see Figure 12 and Figure 13):

- For **control values lower than that of the first point**, the actual regulation value will be 0%. For example, in Figure 13 all control values under 20% imply a regulation value of 0%.
- For **control values greater than that of the last point**, the actual regulation value will be 100%. For example, in Figure 13 all control values over 80% imply a regulation value of 100%.

Notes:

- Please ensure that **different control values are assigned different regulation values**. Otherwise, the regulation may present issues.
- **Intermediate values** between the user-defined points are calculated by linear interpolation.
- The **status objects** will always refer to the control values, between 0% and 100%, with independence of the curve being implemented, which is typically irrelevant for the final user.

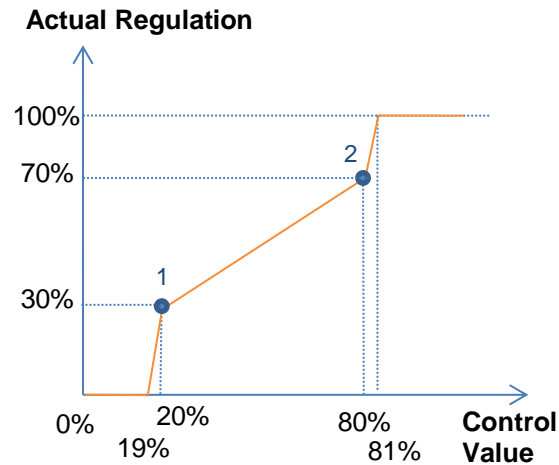

Figure 13. Values Out of Range

ETS PARAMETERISATION

After enabling “**Characteristic Curve**” in the channel configuration screen (see section 2.2.2), a new tab will be incorporated into the tab tree on the left.

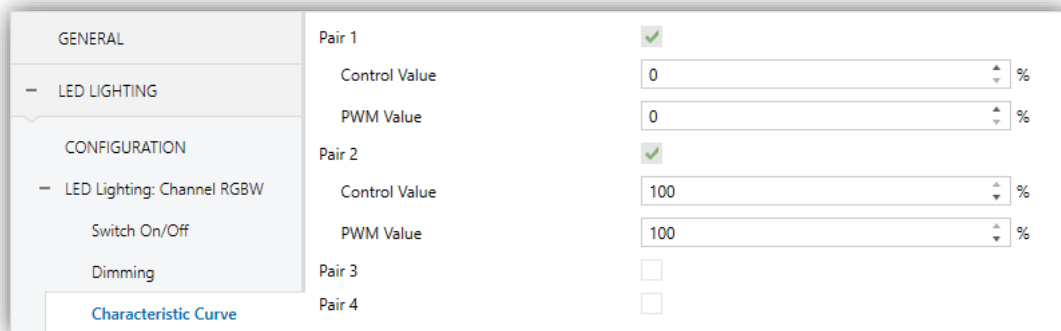

Figure 14. Characteristic Curve.

Contains the parameters required to define up to four points of the characteristic curve:

- **Control Value [%]**: input value received through the one-byte control object (value in the “x” axis).
- **PWM Value [%]**: real value applied to the output to control the load when the above control value is received (value in the “y” axis).

Note: please ensure that points 1 through 4 have different control values (i.e., each control value must correspond to only one regulation value), and that these values are

sorted in ascending order (control value 1 < control value 2 < control value 3 < control value 4). Otherwise, the output regulation function may behave abnormally.

2.2.2.5 COLOR SELECTION OBJECTS (ONLY RGB / RGBW CHANNELS)

For RGB, RGBW and RGB+W configurations, Lumento DX4 provides different procedures for selecting the desired joint colour:

- **Through a three-byte object** that sets the illumination level (in percentage) of the main colour components (R, G and B).
- **Through a one-byte direct colour object**, which permits selecting (by sending an integer value between 0 and 21) any of the following twenty-two pre-set colours:

Scene (Value)	Colour	R	G	B	W
1 (0)	Off	0	0	0	0
2 (1)	White	255	255	255	255
3 (2)	White – Light	128	128	128	128
4 (3)	Blue	0	0	255	0
5 (4)	Blue – Light	102	204	255	51
6 (5)	Blue – Navy	0	0	102	0
7 (6)	Blue – Cyan	0	255	255	0
8 (7)	Blue – Turquoise	0	255	77	51
9 (8)	Blue – Lavender	128	128	255	51
10 (9)	Green	0	255	0	0
11 (10)	Green – Light	128	255	51	51
12 (11)	Green – Dark	0	102	0	0
13 (12)	Green – Lime	128	255	0	13
14 (13)	Red	255	0	0	0
15 (14)	Red – Pink	255	0	77	0
16 (15)	Red – Dark	102	0	0	0
17 (16)	Red – Magenta	255	0	255	0
18 (17)	Red – Fuchsia	255	26	51	0
19 (18)	Yellow	255	255	0	0
20 (19)	Orange	255	51	0	0
21 (20)	Lilac	255	128	128	0
22 (21)	Purple	170	0	255	0



Table 2. Direct Color

- **By triggering a colour scan**, which will start from the nearest stage among those shown in the figure below, and may be interrupted once the desired colour is reached.

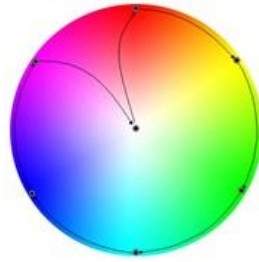

Figure 15. Colour Scan

ETS PARAMETERISATION

Enabling the **Colour Selection Objects** parameter (disabled by default) will enable as well the following communication objects:

- “[Ch] **RGB Colour**”: three-byte object which allows setting the luminosity of each component (between 0 and 255). Thus, the first byte represents the red channel (R) illumination, while the second byte represents that of the green channel (G) and the third one refers to the blue channel (B).
- “[Ch] **Direct Colour**”: one-byte object for choosing one of the 22 pre-set colours (Table 2).
- “[Ch] **Colour Shift**”: two homologous objects of one-bit and four-bit size, respectively, to start or stop the colour scan function (Figure 15).
 - The **one-bit** object is destined to combine this functionality with a simple, binary control.
 - The **four-bit** object allows integrating this functionality into light-dimming one-button controls: orders to increase the light level will trigger a forward colour scan, while orders to decrease the light level will trigger a backward colour scan. Table 3 shows the length of the scan depending on the step order received (note that the entire scan takes place in any of the cases).

Increase/Decrease	Period (s)
100%	30
50%	25
25%	20
12.5%	15
6.25%	12
3.12%	7
1.5%	4
Stop	Interrupt scan

Table 3. Scan length depending on the step order received

Example:

Suppose a one-button (toggle) dimming control on the **Flat 55** from Zennio. If it has been assigned a dimming step of 25% and the communication objects (including the status objects) have been properly linked to those in Lumento C:

- Being the LED module off, when the user performs a long press on the button, Flat 55 sends an order to increase by 25%. The LED module switches on and the colour scan begins, with a 20 second period.
- When the user releases the button Flat 55 sends an order stop, so the colour shift is interrupted. From that moment on, the user may perform further long presses to start over the colour scan, or a short press to switch off the module.

2.2.2.6 CUSTOM ON/OFF

This function offers up to four additional On/Off controls for the output channel, and therefore up to four new communication objects to switch the load on and off.

These additional controls may be customised with specific illumination levels for the “on” and “off” states, and may also be configured to perform an immediate or soft dimming.

ETS PARAMETERISATION

Once enabled, the following parameters will show in ETS:

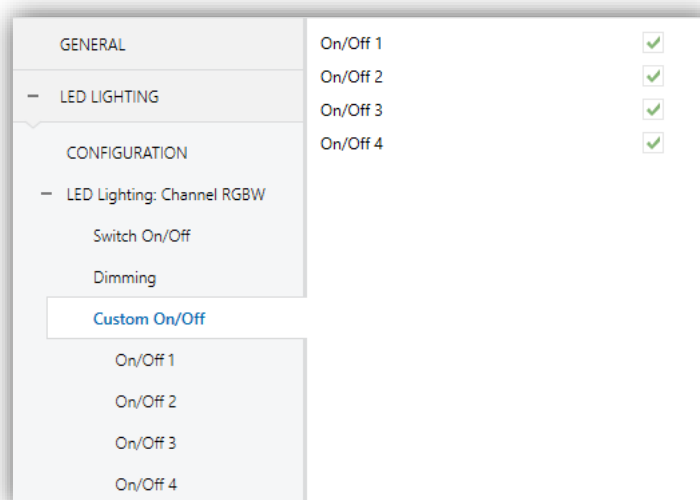

Figure 16. Custom On/Off

- **On/Off ‘n’** [*enabled/disabled*]: once enabled, the “[Ch] Custom On/Off ‘n’” one-bit object and a specific parameter tab will show in ETS:

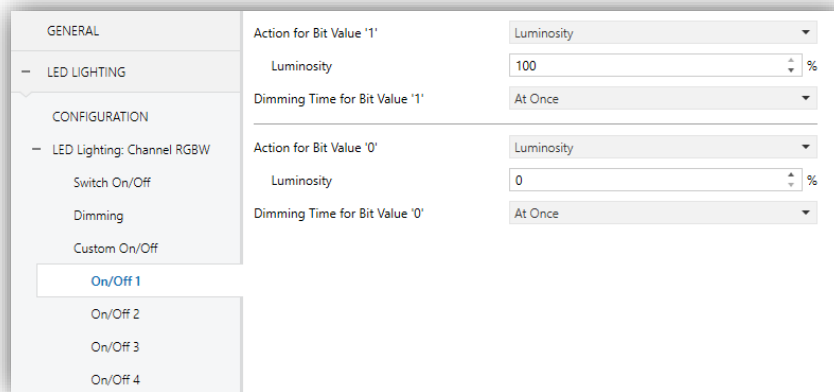

Figure 17. Custom On/Off (detail)

This screen allows setting up the specific behaviour when a “1” or a “0” are received through object “[Ch] Custom On/Off ‘n’”:

- **Action for Bit Value ‘1’** [*Luminosity / Predefined Color / RGB/RGBW Color*] (only RGB / RGBW channels): sets the action to perform when a “1” is received through “[C] Custom On/Off ‘n’”. One of the following actions may be chosen:
 - **Luminosity** [*0...100*][%]: sets a specific illumination percentage (0% to 100%) to be applied to the channel when a “1” is received.
 - **Predefined Colour** [*WHITE / BLUE / GREEN / RED / YELLOW / ORANGE / LILAC / PURPLE*]: permits selecting one of the pre-set colours (see Table 2).
 - **R / G / B / W** [*0...255*] : sets a specific luminosity value cfor each of the colour components.
- **Dimming Value for Bit Value ‘1’** (only individual channels and white channel): equivalent to the above “*Luminosity*” option, although it only applies to a specific individual channel.
- **Dimming Time for Bit Value ‘1’** [*At Once / Dimming Time 1 / Dimming Time 2 / Dimming Time 3*]: allows selecting the dimming type (in terms of speed)

which will be applied to the transition from current level to that set in the previous parameter. See section 2.2.2.

- **Action for Bit Value '0'**: analogous to the above **Action for Bit Value '1'**, but referred to the arrival of the value "0" from the bus.
- **Dimming Value for Bit Value '0'**: analogous to the above **Dimming Value for Bit Value '1'**, but referred to the arrival of the value "0" from the bus.
- **Dimming Time for Bit Value '0'**: analogous to the above **Dimming Time for Bit Value '1'**, but referred to the arrival of the value "0" from the bus.

2.2.2.7 AUTO OFF

If the Auto Off function is enabled, the load controlled by the channel will automatically turn off after a certain time with a light level lower than a parameterisable limit.

The Auto Off function counts the time elapsed after the output falls below a certain threshold light level. If this count exceeds the parameterised timeout, Lumento DX4 will turn the load off. The count will stop if an order to increase back the light level over that limit is received.

ETS PARAMETERISATION

GENERAL	Luminosity (Threshold)	5	%
LED LIGHTING	Time	10	
CONFIGURATION		<input checked="" type="radio"/> s <input type="radio"/> min	
LED Lighting: Channel RGBW			
Switch On/Off			
Dimming			
Auto Off			

Figure 18. Auto Off

The only parameters contained by the Auto Off specific screen are:

- **Luminosity (Threshold) [5...70][%]**: sets the desired light level that will trigger the time count.

- **Time** [10...255][s] / [1...255][min]: sets the time that should elapse before turning the channel off.

2.2.2.8 TIMERS

This function allows configuring a **simple timing** and a **flashing sequence** in the output channel, being it possible to enable or disable both functions independently.

The **simple timing** function consists in a switch-on of the channel (with an optional delay) on the reception of the corresponding trigger object, and a later switch-off, either automatic (after a certain period) or triggered through the corresponding bus object, also with an optional delay in this case.

On the other hand, the **flashing** function consists in switching the channel on and off a certain number of times or indefinitely, according to the parameters, once the corresponding object is received.

ETS PARAMETERISATION

Once enabled, the following parameters will show in ETS:

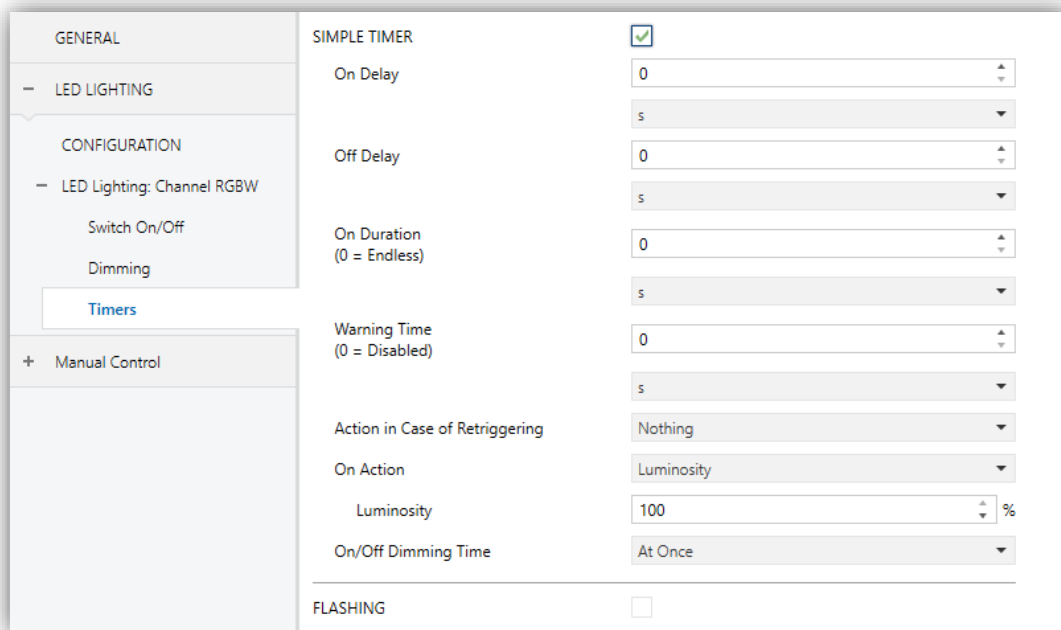

Figure 19. Simple Timer.

- **SIMPLE TIMER** [*enabled/disabled*]: checkbox to enable or disable the simple timer function, as well as its specific parameters and the “[Ch] Simple Timer” one-bit object, which will trigger a delayed switch-on when the value “1” is received, and a delayed switch-off when the received value is “0”.
 - **On Delay** [*0...100*][ds] / [*0...100*][s] / [*0...100*][min]: sets a delay between the reception of the simple timer trigger order (value “1” through object “[Ch] Simple Timer”) and the actual switch-on of the channel.
 - **Off Delay** [*0...100*][ds] / [*0...100*][s] / [*0...100*][min]: sets a delay between the reception of the simple timer stop order (value “0” through object “[Ch] Simple Timer”) and the actual switch-off of the channel.
 - **On Duration** [*0...100*][ds] / [*0...100*][s] / [*0...100*][min]: sets the time the output channel must remain on before being automatically switched off (unless a simple timer stop order is received. The value “0” (default option) will disable the automatic switch-off, thus making the simple timer switch-on state endless.

Note: *the time space defined here refers to the entire “On” stage, including (if applicable) the smooth dimming time. In case the dimming is too slow and the “On Duration” time too short, only a partial light transition will take place.*

- **Warning Time** [*0...100*][ds] / [*0...100*][s] / [*0...100*][min]: sets an anticipation time prior to the switch-off action so that the channel reduces to 50% the current luminosity to notify that the timer action is about to end. Moreover, the “[Ch] Warning Time (Status)” object will acquire a value of “1” while this luminosity reduction is running. If set to zero, no warning will take place. Note that this time needs to be lower than the ON Duration time.
- **Action in Case of Retriggering** [Nothing / Restart / Multiply]: sets the action to be performed in case the value “1” is received several times:
 - **Nothing:** the current time count will not be restarted.
 - **Restart:** the time count of the On Duration will be restarted from zero.
 - **Multiply:** the On Duration will become ‘n’ times the configured time, being ‘n’ the number of times the value “1” is received.

Example:

On Delay: 2 s
 Off Delay: 4 s
 On Duration: 6 s
 On Value: 100%
 On/Off Dimming Time: At Once.

Restart

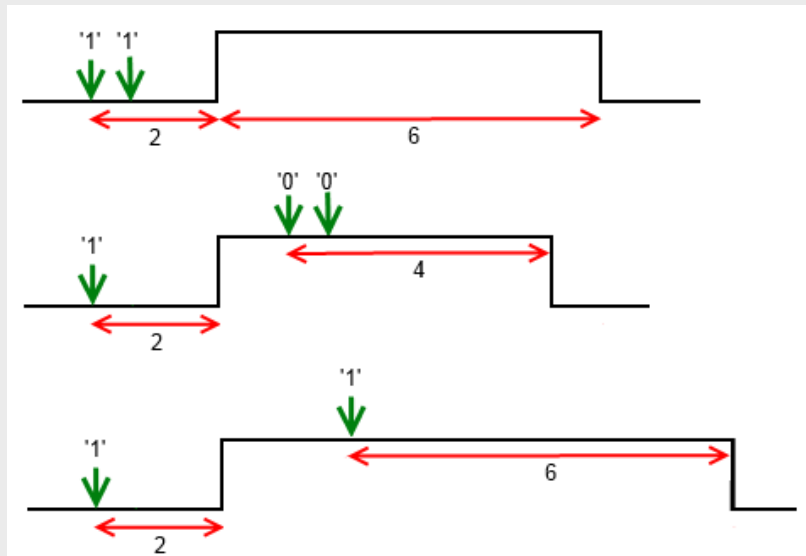

Multiply

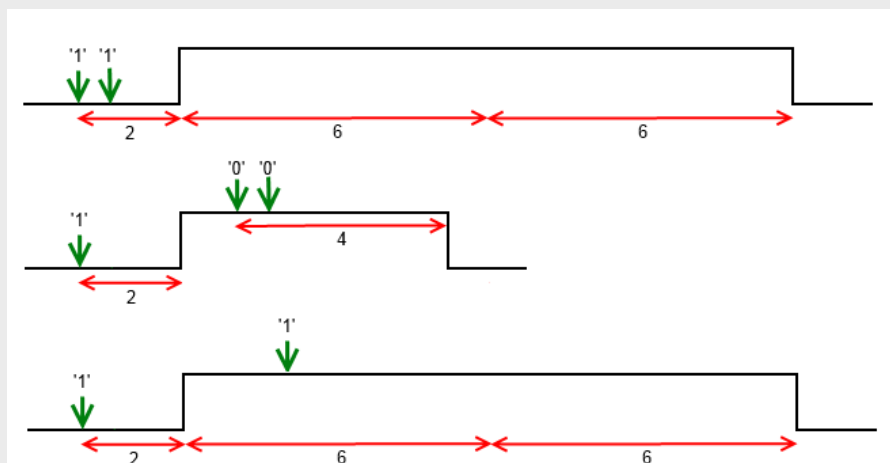

- **On Action** [[Luminosity](#) / [Predefined Color](#) / [RGB/RGBW Color](#)] (only RGB / RGBW channels): sets the action to be performed when the value “1” is received through “[Ch] Simple Timer (analogously as in section 2.2.2.6).

- **On Value** (only individual or W channels): analogous to choosing “Luminosity” in the previous parameter (**On Action**).
- **On/Off Dimming Time** [[At Once](#) / [Dimming Time 1](#) / [Dimming Time 2](#) / [Dimming Time 3](#)] (see “Dimming times” in section 2.2.2).

Note: the simple timer function will be interrupted whenever any other dimming action is commanded, no matter if it falls within the On Duration or during the on / off delays.

- **FLASHING** [[enabled/disabled](#)]: checkbox to enable or disable the flashing function, as well as its specific parameters and the “[Ch] Flashing” one-bit object, which will trigger an On-Off-On... sequence when the value “1” is received, and will interrupt it by sending the value “0”.

GENERAL	SIMPLE TIMER	
LED LIGHTING	FLASHING	<input checked="" type="checkbox"/>
CONFIGURATION	On Duration	1
LED Lighting: Channel RGBW		s
Switch On/Off	Off Duration	1
Dimming		s
Timers	Repetitions (0 = Endless)	0
Manual Control	On Action	Luminosity
	Luminosity	100 %
	Final Action	Luminosity
	Luminosity	0 %

Figure 20. Flashing

- **On Duration** [[1...100](#)][ds] / [[1...100](#)][s] / [[1...100](#)][min]: sets the length of each “On” stage during the sequence.

Note: the time space defined here refers to the entire “On” stage, including (if applicable) the smooth dimming time. In case the dimming is too slow and the “On Duration” time too short, only a partial light transition will take place.

- **Of Duration** [[1...100](#)][ds] / [[1...100](#)][s] / [[1...100](#)][min]: sets the length of each “Off” stage during the sequence.

- **Repetitions** [0...255]: sets the number of iterations of the sequence. The value “0” causes an endless repetition, until an order to interrupt the sequence is received.
- **On Action** [Luminosity / Predefined Color / RGB/RGBW Color] (only RGB / RGBW channels): sets the action to be performed during the “On” stages of the sequence (analogously as in section 2.2.2.6).
 - **On Value** (only individual or W channels): analogous to choosing “Luminosity” in the previous parameter (**On Action**).
- **Final Action** [Luminosity / Predefined Color / RGB/RGBW Color] (only RGB / RGBW channels): sets the action to be performed after the last iteration of the sequence, as well as when the value “0” is received through “[Ch] **Flashing** (analogously as in section 2.2.2.6).
 - **Final Value** (only individual or W channels): analogous to choosing “Luminosity” in the previous parameter (**Final Action**).

2.2.2.9 SCENES/SEQUENCES

This feature allows defining different scenes, i.e., specific ambiances or dimming sequences, which may be activated by sending the corresponding trigger value to the **on-byte scenes / sequences objects**.

Lumento DX4 offers **up to five** scenes / sequences per each individual or white channel and **up to ten** scenes / sequences per RGB or RGBW channel.

ETS PARAMETERISATION

Once this function has been enabled, the following objects will show in ETS:

- “[Cx] **Scenes/Sequences**”: triggers the scene or sequence whose number corresponds to the value received through the object (see below).
- “[Cx] **Start/Stop Sequence**” (one bit): allows to start the last sequence performed, or re-start the one currently in execution (sending the value “1”), as well as interrupting the current sequence (value “0”).

Note: the “[Cx] **Start/Stop Sequence**” object only applies to sequences, and has no effect over static scenes. Moreover, after a download from ETS (partial

or complete), if the value “1” is sent through this object, Lumento DX4 will trigger the first, non-static sequence parameterised.

The “Scenes/Sequences” tab in ETS contains the following parameters:

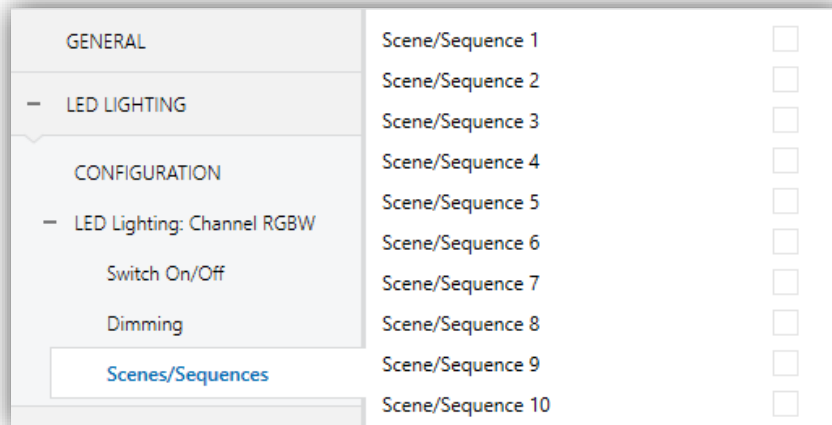

Figure 21. Scenes/Sequences

Each scene / sequence activated from this screen will have a specific tab associated, labelled as “**Scene/Sequence ‘n’**” and containing the following parameters:

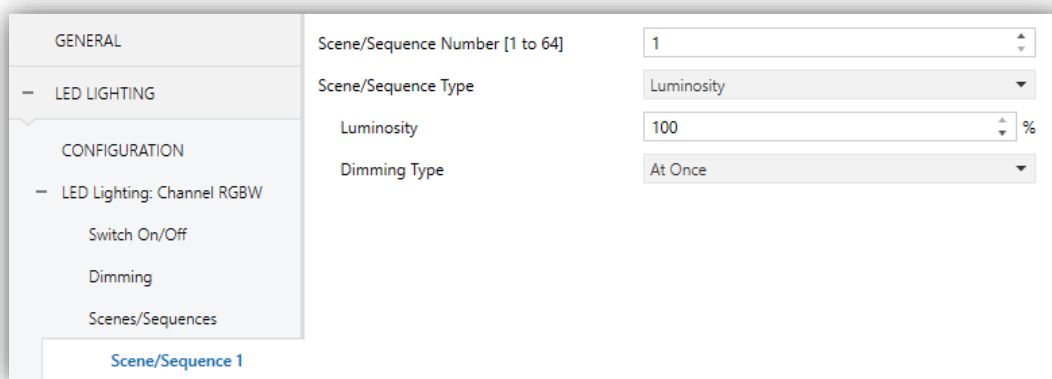

Figure 22. Scene configuration

The following parameters are available:

- **Scene/Sequence Number [1...64]:** sets the scene/sequence identifying number whose reception (decreased by 1, according to the KNX standard) through the “[Ch] Scenes/Sequences” object will make the device trigger the scene/sequence.

- **Scene/Sequence Type** [[Luminosity](#) / [Predefined Color](#) / [RGB/RGBW Color](#) / [Predefined Sequence](#) / [Custom Sequence](#)]: selects the desired action on the activation of the scene/sequence:

- **Luminosity** (only RGB / RGBW channels): the scene activation will consist in setting a fixed illumination value (0% to 100%) in the channel.

The following parameters will show up:

- **Luminosity** [[0...100](#)][%]: sets the desired illumination level percentage.
- **Dimming Type** [[At Once](#) / [Dimming Time 1](#) / [Dimming Time 2](#) / [Dimming Time 3](#)]: see section 2.2.2.

In this case it will be also possible to **save scenes**. If a scene saving order (values 128 to 191) is received, the current luminosity level of the channel will be taken into account for later triggers of the corresponding scene.

- **Predefined Colour** (only RGB / RGBW channels): the execution of the scene will consist in setting a specific pre-set colour. See Table 2.

This option also entails the following parameters:

- **Predefined Colour** [[WHITE](#) / [BLUE](#) / [GREEN](#) / [RED](#) / [YELLOW](#) / [ORANGE](#) / [LILAC](#) / [PURPLE](#)]: sets the desired colour.
- **Dimming Type** [[At Once](#) / [Dimming Time 1](#) / [Dimming Time 2](#) / [Dimming Time 3](#)]: see section 2.2.2.

- **RGB Colour/ RGBW Colour** (only RGB / RGBW channels): the execution of the scene will consist in setting fixed values to the R, G, B and W (if existing) colour components. The following parameter will also be available:

- **R / G / B / W** [[0...255](#)]: sets a specific luminosity value for each of the colour components.
- **Dimming Type** [[At Once](#) / [Dimming Time 1](#) / [Dimming Time 2](#) / [Dimming Time 3](#)]: see section 2.2.2.

In this case it will be also possible to **save scenes**. If a scene saving order (values 128 to 191) is received, the current lighting values of each channel will be taken into account for later triggers of the corresponding scene.

- **Fixed Value** [0...100][%]: (only individual or W channels): the scene activation will consist in setting a fixed illumination value in the channel.
- **Predefined Sequence** (only RGB / RGBW channels): the execution of the scene will consist in a predefined colour sequence, configurable through the following parameters:

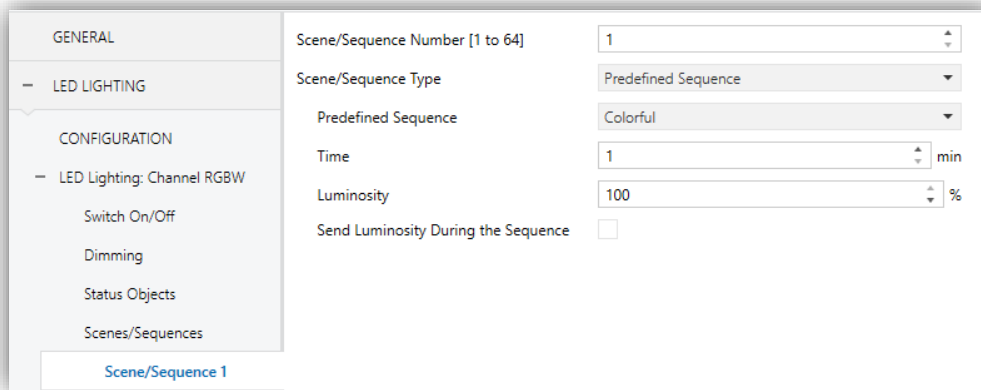

Figure 23. Pre-defined sequence

- **Predefined Sequence** [*Colourful / Cool Colours / Warm Colours / Sunrise / Sunset / TV/Presence Simulation*]. The specific colour transition of each sequence is listed below.

“**Colourful**” (cyclic sequence).

Step#	Colour	RGBW	Period
1	Red	255/0/0/0	t/5
2	Green	0/255/0/0	t/5
3	Blue	0/0/255/0	t/5
4	Magenta	255/0/255/0	t/5
5	Yellow	255/255/0/0	t/5

“**Cool colours**” (cyclic sequence).

Step#	Colour	RGBW	Period
1	Blue 1	100/128/255/0	t/5
2	Green 1	20/255/100/0	t/5
3	Green	0/255/0/0	t/5
4	Green 2	0/255/77/0	t/5
5	Blue	0/0/255/0	t/5

“**Warm colours**” (cyclic sequence).

Step#	Colour	RGBW	Period
1	Red	255/0/0/0	t/5
2	Magenta	255/0/255/0	t/5
3	Pink	255/0/77/0	t/5
4	Orange	255/51/0/0	t/5
5	Yellow	255/255/0/0	t/5



“Sunrise” (non-cyclical sequence; executed only once, performs a colour transition from darker to brighter colours, which will depend on the Final Luminosity parameterised)

Step#	Colour	RGBW	Luminosity	Period
1	Switched Off	0/0/0/0	0%	0
2	Red	63/0/0/0	25%	t/4
3	Orange	128/25/0/0	50%	t/4
4	Yellow	191/191/0/0	75%	t/4
5	White	255/255/255/0	100%	t/4



“Sunset” (non-cyclical sequence; executed only once, performs a colour transition from brighter to darker colours, which will depend on the Final Luminosity parameterised).

Step#	Colour	RGB/RGBW	Luminosity	Period
1	White	255/255/255/0	100%	0
2	Yellow	191/191/0/0	75%	t/4
3	Orange	128/25/0/0	50%	t/4
4	Red	63/0/0/0	25%	t/4
5	Switched Off	0/0/0/0	0%	t/4



“TV/Presence Simulation” (sequence showing random colours and times; the colour transitions are immediate).

- **Time** [1...100][min] (not available for “TV/Presence Simulation”): sets the length of a full cycle of the sequence.
- **Luminosity** [0...100][%] (not available for “Sunset” or “Sunrise”): sets the luminosity that will be applied along the sequence execution.
- **Final Luminosity** [0...100][%] (“Sunrise” only): sets the luminosity to be applied at the end of the sequence.

- **Initial Luminosity** [0...100][%] (“Sunset” only): sets the luminosity to be applied at the beginning of the sequence.
- **Send Luminosity During the Sequence** [*enabled/disabled*]: enables or disables a periodic sending of the status object while the sequence is running.

Note: *this option will not be available unless parameter **Send Luminosity While Dimming** has been activated (see section 2.2.2.1). The sending period will be in accordance to the one configured there.*

➤ **Custom Sequence:** brings the option to define sequences **up to five steps**, and to configure the following parameters:

- **Cyclic** [*enabled/disabled*]: “Enabled” (after the last step, the sequence will start over) or “Disabled” (default option; in such case, after the last step, it will be possible to automatically trigger any other sequence parameterised).
- **Next Sequence** [*No Sequence / Sequence n*] (being ‘n’ a value between 1 and 5 for individual / white channels, or between 1 and 10 for RGB / RGBW channels): only available if **Cyclic** has been disabled; allows the execution of another sequence after the last step of the current sequence.

Additionally, each individual sequence step offers the following parameters:

- **Action** [*Luminosity / Predefined Colour / RGB/RGBW Colour*]: (only RGB / RGBW channels): sets the action to perform in the current step. See section 2.2.2.6.
- **Value** [0...100][%]: (only individual or W channels): analogous to choosing “Luminosity” in the previous parameter (**Action**).
- **Dimming Type** [*At Once / Dimming Time 1 / Dimming Time 2 / Dimming Time 3 / Equal to Action Time*]: the latter makes the dimming length (see section 2.2.2) match the action time configured.
- **Action time** [1...100][ds] / [1...10...100][s] / [1...100][min]: defines the duration of the action, i.e., the time it will take until the next action begins execution. The available range is 1 to 100 tenths of a second, seconds or minutes.

Note: in the event of an action time greater than the selected **Dimming Type**, the channel will remain in the same state until this time is over.

Actions will be run in order (starting from the first one), once Lumento DX4 receives through “[Ch] Scenes/Sequences” the value that triggers the sequence. Moreover, if the sequence is configured as “Cyclic”, once the last action ends, the sequence will be restarted.

Section	Parameter	Value
GENERAL	Scene/Sequence Number [1 to 64]	1
	Scene/Sequence Type	Custom Sequence
	Cyclic	<input type="checkbox"/>
	Next Sequence	Sequence 7
CONFIGURATION	Send Luminosity During the Sequence	<input type="checkbox"/>
	Action 1	
	Action	Luminosity
	Luminosity	74 %
	Dimming Type	Dimming Time 1
	Action Time	25 s
	Action 2	
	Action	Predefined Color
	Color	BLUE (Turquoise)
	Dimming Type	Equal to Action Time
	Action Time	10 s
	Action 3	
Action	RGBW Color	
R	255	
G	51	
B	15	
W	40	
Dimming Type	At Once	
Action Time	10 s	
Action 4		
Action	<input type="checkbox"/>	
Action 5		
Action	<input type="checkbox"/>	

Figure 24. Custom Sequence

2.2.2.10 LOCK

Enabling the lock function will bring a **one-bit** object which will allow locking and unlocking the related channel. Channel locking will cause ignoring any bus orders addressed to that channel.

Receiving a lock order while running a sequence, intermittence, temporisation or automatic colour shift **will stop the execution of that action as well as the sending of the status objects.**

ETS PARAMETERISATION

Once this function has been enabled, the following objects will show in ETS:

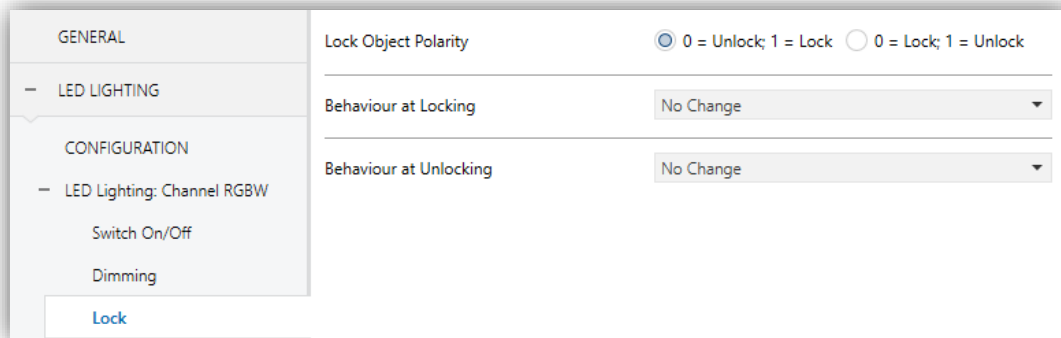

Figure 25. Lock

- **Lock Object Polarity** [*0 = Unlock; 1 = Lock / 0 = Lock; 1 = Unlock*]: sets which value will be interpreted as a locking order and which one as an unlocking order.
- **Behaviour at Locking** [*No change / Off / On / Fixed Value*]: sets the action to be performed when a locking order is received. The last option offers the options “Luminosity”, “Predefined Colour” and “RGB/RGBW Colour”, already explained in section 2.2.2.6).
- **Behaviour at Unlocking** [*No change / Off / On / Previous State Before Locking / Fixed Value*]: sets the action to be performed when an unlocking order is received.

2.2.2.11 CUSTOM INITIALISATION

This function permits customising the initial state of the channel at the start-up of the device.

Opting for the **default initial configuration** implies the following:

- After an ETS download, the channel will remain off.

- After recovering from a bus power failure, the channel will recover the state previous to the power failure.

On the other hand, opting for a **custom initial configuration** allows parameterising the desired channel state after the bus power is restored or after a download.

ETS PARAMETERISATION

Once the option to customise the initial configuration has been enabled in the “General” window (otherwise, the default configuration will be applied), the following objects will show in ETS:

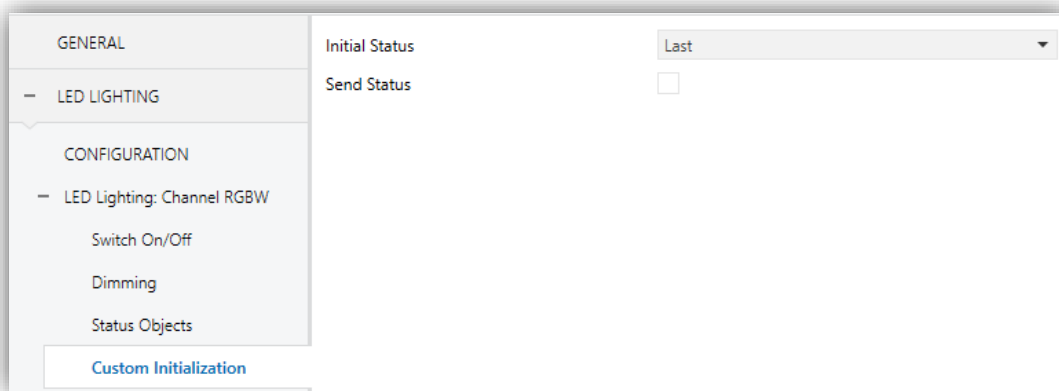

Figure 26. Custom initialisation

Selecting this tab will allow setting up the following features and parameters:

- **Initial Status** [Last / Off / Fixed Value]: sets the desired initial state of the channel:
 - **Last**: when the bus power is restored, the channel will recover the illumination state previous to the bus failure. Note that this option has no effect after a download (the channel will remain off).
 - **Off**: the channel will always start off.
 - **Fixed Value**: the channel will start with a specific configuration: “Luminosity”, “Predefined Colour” and “RGB/RGBW Colour”, as explained in section 2.2.2.6.

- **Send Status** [*Disabled / enabled*]: if enabled, the status objects will be sent to the bus at the start-up of Lumento DX4, thus informing other devices about the initial state of the channel. This requires that the status objects have been enabled in parameters (see section 2.2.2).
- **Delay** [0...255][s]: sets the time (in seconds) that Lumento DX4 will wait before performing this sending.

Note: *in case the initial state of the output does not match the last value sent to the bus through the status objects before the reset, an immediate sending will take place at the start-up of the device, no matter if the **Send Status** function (delayed or not) has not been enabled.*

2.3 INPUTS

Lumento DX4 incorporates **six analogue/digital inputs**, each configurable as a:

- **Binary Input**, for the connection of a pushbutton or a switch/sensor.
- **Motion Detector**, for the connection of a motion detector from Zennio.

2.3.1 BINARY INPUTS

Please refer to the specific “**Binary Inputs**” user manual, available under the Lumento DX4 product section at www.zennio.com.

2.3.2 MOTION DETECTOR

It is possible to connect motion detectors to the input ports of Lumento DX4. This brings the device with the possibility of monitoring motion and presence in the room, as well as the light level. Depending on the detection, different response actions can be parameterised.

Please refer to the “**Motion Detector**” user manual, available under the Lumento DX4 product section at www.zennio.com, for detailed information about the functionality and the configuration of the related parameters.

2.4 MASTER LIGHT CONTROL

The Master Light function brings the option to monitor the state of up to 12 light sources (or even more, if the Master Light controls from multiple Zennio devices are linked together) or of any other elements whose state is transmitted through a binary object and, depending on those states, perform a **master order** every time a certain trigger signal (again, a binary value) is received through a specific object.

Such master order will consist in:

- A **general switch-off** order, if at least one of the up to twelve status objects is found to be on.
- A **courtesy switch-on** order, if none of the up to twelve status objects is found to be on.

Note that the above switch-off and switch-on orders are not necessarily a binary value being sent to the bus – it is up to the integrator the decision of what to send to the KNX bus in both cases: a shutter order, a thermostat setpoint or mode switch order, a constant value, a scene... Only the trigger object and the twelve status objects are required to be binary (on/off).

The most typical scenario for this Master Light control would be a hotel room with a master pushbutton next to the door. When leaving the room, the guest will have the possibility of pressing on the master pushbutton and make all the lamps turn off together. Afterwards, back on the room and with all the lamps off, pressing on the same master pushbutton will only make a particular lamp turn on (e.g., the closest lamp to the door) – this is the courtesy switch-on.

Besides, it is possible to concatenate two or more Master Light modules by means of a specific communication object which represents the general state of the light sources of each module. Thereby, it is possible to expand the number of light sources by considering the general state of one module as an additional light source for another.

ETS PARAMETERISATION

Once the Master Light function has been enabled, a specific tab will be included in the menu on the left. This new parameter screen (Figure 27) contains the following options:

GENERAL	Number of State Objects	1
+ LED LIGHTING	Trigger Value	0/1
- Master Light	General Switch Off	
Configuration	Delay	0 x 1 s
+ Manual Control	Binary Value	<input checked="" type="checkbox"/>
	Scaling	<input type="checkbox"/>
	Scene	<input type="checkbox"/>
	HVAC	<input type="checkbox"/>
	Courtesy Switch On	
	Delay	0 x 1 s
	Binary Value	<input checked="" type="checkbox"/>
	Scaling	<input type="checkbox"/>
	Scene	<input type="checkbox"/>
	HVAC	<input type="checkbox"/>

Figure 27. Master Light Control

- **Number of State Objects** [1...12]: defines the number of 1-bit status objects required. These objects are called “[ML] Status Object *n*”.

In addition, the general status object (“[ML] General status”) will always be available in the project topology. It will be sent to the bus with a value of “1” whenever there is at least one of the above state objects with such value. Otherwise (i.e., if none of them has a value of “1”), it will be sent with a value of “0”.

- **Trigger Value** [0 / 1 / 0/1]: sets the value that will trigger, when received through “[ML] Trigger”, the master action (the general switch-off or the courtesy switch-on).

- **General Switch-Off.**

- **Delay** [0...255][s]: defines a certain delay (once the trigger has been received) before the execution of the general switch-off.
- **Binary Value** [Disabled / Enabled]: if checked, object “[ML] General Switch-off: Binary Object” will be enabled, which will send one “0” whenever the general switch-off takes off.

- **Scaling** [[Disabled](#) / [Enabled](#)]: if checked, object “[ML] General Switch-off: Scaling” will be enabled, which will send a percentage value (configurable in “Value” [[0...100](#)][%]) whenever the general switch-off takes off.
- **Scene** [[Disabled](#) / [Enabled](#)]: if checked, object “[ML] General Switch-off: Scene” will be enabled, which will send a scene run / save order (configurable in “Action” [[Run](#) / [Save](#)] and “Scene Number” [[0...64](#)]) whenever the general switch-off takes off
- **HVAC** [[Disabled](#) / [Enabled](#)]: if checked, object “[ML] General Switch-off: HVAC mode” will be enabled, which will send an HVAC thermostat mode value (configurable in “Value” [[Auto](#) / [Comfort](#) / [Standby](#) / [Economy](#) / [Building Protection](#)]) whenever the general switch-off takes off

Note: *the above options are not mutually exclusive; it is possible to send values of different nature together.*

● **Courtesy Switch-On:**

The parameters available here are entirely analogous to those already mentioned for General Switch-Off. However, in this case the names of the objects start with “[ML] Courtesy Switch-On (...)”. On the other hand, sending **scene save orders** is not possible for the courtesy switch-on (only orders to play scenes are allowed).

Note: object “[ML] Courtesy Switch-On: Binary Object” sends the value “1” (when the courtesy switch-on takes place), in contrast to object “[ML] General Switch-Off: Binary Object”, which sends the value “0” (during the general switch-off, as explained above).

2.5 MANUAL CONTROL

This device incorporates a frontal panel with the following elements (see section 1.2):

- One button for each output.
- One green LED for each output.
- Two buttons associated to the RGB and RGBW control.
- Two three-colour LEDs that indicate the same colour as the outputs under an RGB / RGBW control.

Lumento DX4 allows manually switching the state of its channels through the respective pushbuttons on the top side of the device.

Manual operation can be done in two different ways, named as **Test On mode** (for testing purposes during the configuration of the device) and **Test Off mode** (for a normal use, anytime). Whether both, only one, or none of these modes should be accessible needs to be parameterised in ETS. Moreover, it is possible to enable a specific binary object for locking and unlocking the manual control in runtime.

Notes:

- *The Test Off mode will be active (unless it has been disabled in parameters) after a download or a reset with no need of a specific activation – the pushbuttons will respond to user presses from the start.*
- *On the contrary, switching to the Test On mode (unless disabled in parameters) needs to be done by long-pressing the Prog./Test button (for at least three seconds), until the LED is no longer red and turns yellow. From that moment, once the button is released, the LED light will remain green to confirm that the device has switched from the Test Off mode to the Test On mode. After that, an additional press will turn the LED yellow and then off, once the button is released. This way, the device leaves the Test On mode. Note that it will also leave this mode if a bus power failure takes place.*

Test Off

Under the Test Off Mode, the channels can be controlled through both their communication objects and the actual pushbuttons located on the top of the device.

When any of these buttons is pressed, the corresponding channel will behave as if an order had been received through the analogous communication object, depending on the channel configuration:

- A **short press** will be equivalent to receiving a switch order (either a switch-on or a switch-off – this will alternate on every short press). The first time, it will always consist in a switch-on, unless the current level is already maximum (in such case, the regulation will be towards 0%). This regulation is subject to the “On/Off Dimming Time” (see section 2.2.2.1) for each channel.
- A **long press** will be equivalent to receiving a relative dimming command (see section 2.2.2.2). The dimming direction will be contrary to that of the previous regulation, although the first time the regulation will always be upwards (unless the current level is already the maximum one – in such case the regulation will be towards 0%). The dimming speed will correspond to that defined in parameters for the relative dimming. Once the pushbutton is released, the regulation is interrupted.

Note: *Both dimming and switch limits will be subject to the parameterisation (economical mode, characteristic curve, etc).*

Besides the button associated with each output, Lumento DX4 provides **two additional buttons that offer the possibility to do a colour shift in one way (←) or another (→) over all the colour range** (available with the connected LEDs).

- These buttons are activated if **Test Off Mode** is enabled and active; and the outputs configuration is **RGBW or RGB+W**.
- A **long press** will be equivalent to receiving a colour shift command (see section 2.2.2.5). If the loads are switched off the colour shift will start from white colour. On the other hand, if the loads are switched on the colour shift will start from the current colour. Once the pushbutton is released, the regulation is interrupted.

Regarding the rest of the functions, the device will behave under the Test Off mode as usual. As stated, button presses during this mode are entirely analogous to the reception of the corresponding orders from the KNX bus, thus the status objects will also be sent normally.

Test On

After entering the Test On mode, it will only be possible to control the output channels through the on-board manual control pushbuttons. Orders received through communication objects will be ignored, with independence of the channel they are addressed to.

Enabling the Test On mode allows the direct control of every channel with independence of the device parameterisation – the output channels can be controlled in the Test On mode no matter if they have not been enabled in parameters:

The channel dimming through the on-board pushbuttons will be analogous to the one in the Test Off mode, with the following remarks:

- **Short press:** will cause immediate regulations to 0% or to 100% (and not to the maximum level configured).
- **Long press:** dimming period will be 10 seconds (from 0% to 100%).

Any orders received from the KXN bus related to the channel operation will be ignored. Moreover, the device will not send the status objects that may correspond to the manual actions performed by the user. **The only exceptions are the lock objects** (they will be considered after leaving the Test On Mode).

Important: *the device is delivered from factory with both manual modes (Test Off and Test On) enabled, although with all channels disabled (thus, the Test Off mode will result functionless).*

ETS PARAMETERISATION

After enabling “**Manual Control**” (enabled by default) in the General screen (see section 2.1), a new tab will be incorporated into the tree on the left.

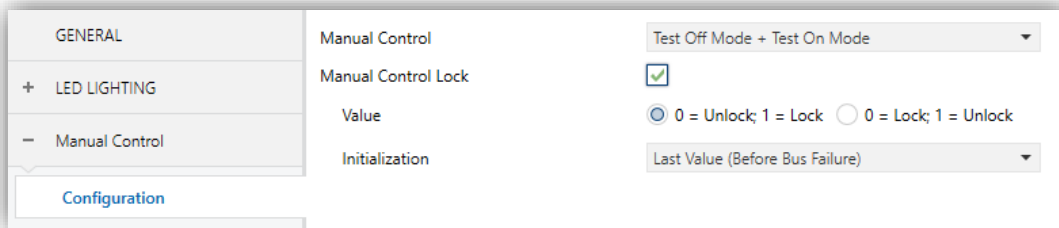

Figure 28. Manual Control

This tab comprises the following parameters:

- **Manual Control** [*Disabled / Only Test Off Mode*, *Only Test On Mode / Test Off Mode + Test On Mode*]: depending on the selection, the device will permit using the manual control under the Test Off, the Test On, or both modes. Note that, as stated before, using the Test Off mode does not require any special action, while switching to the Test On mode does require long-pressing the Prog./Test button.
- **Manual Control Lock** [*Disabled / Enabled*]: unless the above parameter has been disabled, the Lock Manual Control parameter provides an optional procedure for locking the manual control in runtime. When this checkbox is enabled, object “**Manual Control Lock**” turns visible, as well as two more parameters:
 - **Value** [*0 = Unlock; 1 = Lock / 0 = Lock; 1 = Unlock*]: defines whether the manual control lock/unlock should take place respectively upon the reception (through the aforementioned object) of values “0” and “1”, or the opposite.
 - **Initialization** [*Unlocked / Locked / Last Value*]: sets how the lock state of the manual control should remain after the device start-up (after an ETS download or a bus power failure).

ANNEX I. COMMUNICATION OBJECTS

- “Functional range” shows the values that, with independence of any other values permitted by the bus according to the object size, may be of any use or have a particular meaning because of the specifications or restrictions from both the KNX standard or the application programme itself.

Number	Size	I/O	Flags	Data type (DPT)	Functional Range	Name	Function
1	1 Bit	I	C - - W -	DPT_Enable	0/1	Lock Manual Control	0 = Unlock; 1 = Lock
	1 Bit	I	C - - W -	DPT_Enable	0/1	Lock Manual Control	0 = Lock; 1 = Unlock
2	1 Bit	O	CTR - -	DPT_Alarm	0/1	Error: Overheating	0=No Error; 1=Error
3	1 Bit	O	CTR - -	DPT_Alarm	0/1	Error: Overload	0=No Error; 1=Error
4	1 Bit	O	CTR - -	DPT_Alarm	0/1	Error: External Voltage	0=No Error; 1=Error
5, 6, 7, 8	1 Bit	O	CTR - -	DPT_Alarm	0/1	[x] Error: Shortcircuit	0=No Error; 1=Error
5	1 Bit	O	CTR - -	DPT_Alarm	0/1	[R] Error: Shortcircuit	0=No Error; 1=Error
6	1 Bit	O	CTR - -	DPT_Alarm	0/1	[G] Error: Shortcircuit	0=No Error; 1=Error
7	1 Bit	O	CTR - -	DPT_Alarm	0/1	[B] Error: Shortcircuit	0=No Error; 1=Error
8	1 Bit	O	CTR - -	DPT_Alarm	0/1	[W] Error: Shortcircuit	0=No Error; 1=Error
9	1 Byte	I	C - - W -	DPT_Scaling	0% - 100%	[RGB] Maximum Light Level	50 - 100%
	1 Byte	I	C - - W -	DPT_Scaling	0% - 100%	[RGBW] Maximum Light Level	50 - 100%
10	1 Bit	I	C - - W -	DPT_Switch	0/1	[RGBW] Switch On/Off	0=Off; 1=On
	1 Bit	I	C - - W -	DPT_Switch	0/1	[RGB] Switch On/Off	0=Off; 1=On
11	4 Bit	I	C - - W -	DPT_Control_Dimming	0x0 (Stop) 0x1 (Dec. by 100%) ... 0x7 (Dec. by 1%) 0x8 (Stop) 0xD (Inc. by 100%) ... 0xF (Inc. by 1%)	[RGBW] Relative Dimming	4-Bit Dimmer Control
	4 Bit	I	C - - W -	DPT_Control_Dimming	0x0 (Stop) 0x1 (Dec. by 100%) ... 0x7 (Dec. by 1%) 0x8 (Stop) 0xD (Inc. by 100%)	[RGB] Relative Dimming	4-Bit Dimmer Control

					...		
					0xF (Inc. by 1%)		
12	1 Byte	I	C - - W -	DPT_Scaling	0% - 100%	[RGBW] Absolute Dimming	1-Byte Dimmer Control
	1 Byte	I	C - - W -	DPT_Scaling	0% - 100%	[RGB] Absolute Dimming	1-Byte Dimmer Control
13	2 Bytes	I	C - - W -	DPT_TimePeriodSec	0 - 65535	[RGBW] Dimming Time 1	Time in Seconds
	2 Bytes	I	C - - W -	DPT_TimePeriodSec	0 - 65535	[RGB] Dimming Time 1	Time in Seconds
14	2 Bytes	I	C - - W -	DPT_TimePeriodSec	0 - 65535	[RGBW] Dimming Time 2	Time in Seconds
	2 Bytes	I	C - - W -	DPT_TimePeriodSec	0 - 65535	[RGB] Dimming Time 2	Time in Seconds
15	2 Bytes	I	C - - W -	DPT_TimePeriodSec	0 - 65535	[RGBW] Dimming Time 3	Time in Seconds
	2 Bytes	I	C - - W -	DPT_TimePeriodSec	0 - 65535	[RGB] Dimming Time 3	Time in Seconds
16	3 Bytes	I	C - - W -	DPT_Colour_RGB	[0 - 255] * 3	[RGBW] RGB Color	3-bytes RGB Control
	3 Bytes	I	C - - W -	DPT_Colour_RGB	[0 - 255] * 3	[RGB] RGB Color	3-bytes RGB Control
17	1 Byte	I	C - - W -	DPT_SceneControl	0-63; 128-191	[RGBW] Direct Color	Color Number (Scene 1-22)
	1 Byte	I	C - - W -	DPT_SceneControl	0-63; 128-191	[RGB] Direct Color	Color Number (Scene 1-22)
18	1 Bit	I	C - - W -	DPT_Start	0/1	[RGBW] Color Shift	0=Stop; 1=Start
	1 Bit	I	C - - W -	DPT_Start	0/1	[RGB] Color Shift	0=Stop; 1=Start
19	4 Bit	I	C - - W -	DPT_Control_Dimming	0x0 (Stop) 0x1 (Dec. by 100%) ... 0x7 (Dec. by 1%) 0x8 (Stop) 0xD (Inc. by 100%) ... 0xF (Inc. by 1%)	[RGBW] Color Shift	4-bits Color Control
	4 Bit	I	C - - W -	DPT_Control_Dimming	0x0 (Stop) 0x1 (Dec. by 100%) ... 0x7 (Dec. by 1%) 0x8 (Stop) 0xD (Inc. by 100%) ... 0xF (Inc. by 1%)	[RGB] Color Shift	4-bits Color Control
20	1 Bit	I	C - - W -	DPT_Start	0/1	[RGBW] Simple Timer	0=Deactivate; 1=Activate
	1 Bit	I	C - - W -	DPT_Start	0/1	[RGB] Simple Timer	0=Deactivate; 1=Activate
21	1 Bit	O	C T R - -	DPT_Bool	0/1	[RGBW] Warning Time (Status)	0=Deactivated; 1=Activated
	1 Bit	O	C T R - -	DPT_Bool	0/1	[RGB] Warning Time (Status)	0=Deactivated; 1=Activated
22	1 Bit	I	C - - W -	DPT_Start	0/1	[RGBW] Flashing	0=Deactivate; 1=Activate
	1 Bit	I	C - - W -	DPT_Start	0/1	[RGB] Flashing	0=Deactivate; 1=Activate
23	1 Byte	I	C - - W -	DPT_SceneControl	0-63; 128-191	[RGBW] Scenes/Sequences	Scene/Sequence Number
	1 Byte	I	C - - W -	DPT_SceneControl	0-63; 128-191	[RGB] Scenes/Sequences	Scene/Sequence Number

24	1 Bit	I	C - - W -	DPT_Start	0/1	[RGBW] Start/Stop Sequence	0=Stop; 1=Start
	1 Bit	I	C - - W -	DPT_Start	0/1	[RGB] Start/Stop Sequence	0=Stop; 1=Start
25	1 Bit	I	C - - W -	DPT_Switch	0/1	[RGBW] Custom On/Off 1	0=Off; 1=On
	1 Bit	I	C - - W -	DPT_Switch	0/1	[RGB] Custom On/Off 1	0=Off; 1=On
26	1 Bit	I	C - - W -	DPT_Switch	0/1	[RGBW] Custom On/Off 2	0=Off; 1=On
	1 Bit	I	C - - W -	DPT_Switch	0/1	[RGB] Custom On/Off 2	0=Off; 1=On
27	1 Bit	I	C - - W -	DPT_Switch	0/1	[RGBW] Custom On/Off 3	0=Off; 1=On
	1 Bit	I	C - - W -	DPT_Switch	0/1	[RGB] Custom On/Off 3	0=Off; 1=On
28	1 Bit	I	C - - W -	DPT_Switch	0/1	[RGBW] Custom On/Off 4	0=Off; 1=On
	1 Bit	I	C - - W -	DPT_Switch	0/1	[RGB] Custom On/Off 4	0=Off; 1=On
29	1 Bit	I	C - - W -	DPT_Enable	0/1	[RGBW] Lock	0=Unlock; 1=Lock
	1 Bit	I	C - - W -	DPT_Enable	0/1	[RGB] Lock	0=Unlock; 1=Lock
	1 Bit	I	C - - W -	DPT_Enable	0/1	[RGBW] Lock	0=Lock; 1=Unlock
	1 Bit	I	C - - W -	DPT_Enable	0/1	[RGB] Lock	0=Lock; 1=Unlock
30	1 Bit	O	C T R - -	DPT_Switch	0/1	[RGBW] On/Off (Status)	0=Off; 1=On
	1 Bit	O	C T R - -	DPT_Switch	0/1	[RGB] On/Off (Status)	0=Off; 1=On
31	1 Byte	O	C T R - -	DPT_Scaling	0% - 100%	[RGBW] Dimming Value (Status)	0 - 100%
	1 Byte	O	C T R - -	DPT_Scaling	0% - 100%	[RGB] Dimming Value (Status)	0 - 100%
32	3 Bytes	O	C T R - -	DPT_Colour_RGB	[0 - 255] * 3	[RGBW] RGB Dimming Values (Status)	3-bytes Status
	3 Bytes	O	C T R - -	DPT_Colour_RGB	[0 - 255] * 3	[RGB] RGB Dimming Values (Status)	3-bytes Status
33, 52, 71, 90	1 Byte	I	C - - W -	DPT_Scaling	0% - 100%	[x] Maximum Light Level	50 - 100%
34, 53, 72, 91	1 Bit	I	C - - W -	DPT_Switch	0/1	[x] Switch On/Off	0=Off; 1=On
34	1 Bit	I	C - - W -	DPT_Switch	0/1	[R] Switch On/Off	0=Off; 1=On
35, 54, 73, 92	4 Bit	I	C - - W -	DPT_Control_Dimming	0x0 (Stop) 0x1 (Dec. by 100%) ... 0x7 (Dec. by 1%) 0x8 (Stop) 0xD (Inc. by 100%) ... 0xF (Inc. by 1%)	[x] Relative Dimming	4-Bit Dimmer Control
35	4 Bit	I	C - - W -	DPT_Control_Dimming	0x0 (Stop) 0x1 (Dec. by 100%) ... 0x7 (Dec. by 1%) 0x8 (Stop) 0xD (Inc. by 100%) ... 0xF (Inc. by 1%)	[R] Relative Dimming	4-Bit Dimmer Control
36, 55, 74, 93	1 Byte	I	C - - W -	DPT_Scaling	0% - 100%	[x] Absolute Dimming	1-Byte Dimmer Control

36	1 Byte	I	C - - W -	DPT_Scaling	0% - 100%	[R] Absolute Dimming	1-Byte Dimmer Control
37, 56, 75, 94	2 Bytes	I	C - - W -	DPT_TimePeriodSec	0 - 65535	[x] Dimming Time 1	Time in Seconds
38, 57, 76, 95	2 Bytes	I	C - - W -	DPT_TimePeriodSec	0 - 65535	[x] Dimming Time 2	Time in Seconds
39, 58, 77, 96	2 Bytes	I	C - - W -	DPT_TimePeriodSec	0 - 65535	[x] Dimming Time 3	Time in Seconds
40, 59, 78, 97	1 Bit	I	C - - W -	DPT_Start	0/1	[x] Simple Timer	0=Deactivate; 1=Activate
41, 60, 79, 98	1 Bit	O	C T R - -	DPT_Bool	0/1	[x] Warning Time (Status)	0=Deactivated; 1=Activated
42, 61, 80, 99	1 Bit	I	C - - W -	DPT_Start	0/1	[x] Flashing	0=Deactivate; 1=Activate
43, 62, 81, 100	1 Byte	I	C - - W -	DPT_SceneControl	0-63; 128-191	[x] Scenes/Sequences	Scene/Sequence Number
44, 63, 82, 101	1 Bit	I	C - - W -	DPT_Start	0/1	[x] Start/Stop Sequence	0=Stop; 1=Start
45, 64, 83, 102	1 Bit	I	C - - W -	DPT_Switch	0/1	[x] Custom On/Off 1	0=Off; 1=On
46, 65, 84, 103	1 Bit	I	C - - W -	DPT_Switch	0/1	[x] Custom On/Off 2	0=Off; 1=On
47, 66, 85, 104	1 Bit	I	C - - W -	DPT_Switch	0/1	[x] Custom On/Off 3	0=Off; 1=On
48, 67, 86, 105	1 Bit	I	C - - W -	DPT_Switch	0/1	[x] Custom On/Off 4	0=Off; 1=On
49, 68, 87, 106	1 Bit	I	C - - W -	DPT_Enable	0/1	[x] Lock	0=Unlock; 1=Lock
	1 Bit	I	C - - W -	DPT_Enable	0/1	[x] Lock	0=Lock; 1=Unlock
50, 69, 88, 107	1 Bit	O	C T R - -	DPT_Switch	0/1	[x] On/Off (Status)	0=Off; 1=On
50	1 Bit	O	C T R - -	DPT_Switch	0/1	[R] On/Off (Status)	0=Off; 1=On
51, 70, 89, 108	1 Byte	O	C T R - -	DPT_Scaling	0% - 100%	[x] Dimming Value (Status)	0 - 100%
51	1 Byte	O	C T R - -	DPT_Scaling	0% - 100%	[R] Dimming Value (Status)	0 - 100%
53	1 Bit	I	C - - W -	DPT_Switch	0/1	[G] Switch On/Off	0=Off; 1=On
54	4 Bit	I	C - - W -	DPT_Control_Dimming	0x0 (Stop) 0x1 (Dec. by 100%) ... 0x7 (Dec. by 1%) 0x8 (Stop) 0xD (Inc. by 100%) ... 0xF (Inc. by 1%)	[G] Relative Dimming	4-Bit Dimmer Control
55	1 Byte	I	C - - W -	DPT_Scaling	0% - 100%	[G] Absolute Dimming	1-Byte Dimmer Control
69	1 Bit	O	C T R - -	DPT_Switch	0/1	[G] On/Off (Status)	0=Off; 1=On
70	1 Byte	O	C T R - -	DPT_Scaling	0% - 100%	[G] Dimming Value (Status)	0 - 100%
72	1 Bit	I	C - - W -	DPT_Switch	0/1	[B] Switch On/Off	0=Off; 1=On
73	4 Bit	I	C - - W -	DPT_Control_Dimming	0x0 (Stop) 0x1 (Dec. by 100%) ... 0x7 (Dec. by 1%) 0x8 (Stop) 0xD (Inc. by 100%) ... 0xF (Inc. by 1%)	[B] Relative Dimming	4-Bit Dimmer Control

74	1 Byte	I	C - - W -	DPT_Scaling	0% - 100%	[B] Absolute Dimming	1-Byte Dimmer Control
88	1 Bit	O	CTR - -	DPT_Switch	0/1	[B] On/Off (Status)	0=Off; 1=On
89	1 Byte	O	CTR - -	DPT_Scaling	0% - 100%	[B] Dimming Value (Status)	0 - 100%
90	1 Byte	I	C - - W -	DPT_Scaling	0% - 100%	[W] Maximum Light Level	50 - 100%
91	1 Bit	I	C - - W -	DPT_Switch	0/1	[W] Switch On/Off	0=Off; 1=On
92	4 Bit	I	C - - W -	DPT_Control_Dimming	0x0 (Stop) 0x1 (Dec. by 100%) ... 0x7 (Dec. by 1%) 0x8 (Stop) 0xD (Inc. by 100%) ... 0xF (Inc. by 1%)	[W] Relative Dimming	4-Bit Dimmer Control
93	1 Byte	I	C - - W -	DPT_Scaling	0% - 100%	[W] Absolute Dimming	1-Byte Dimmer Control
94	2 Bytes	I	C - - W -	DPT_TimePeriodSec	0 - 65535	[W] Dimming Time 1	Time in Seconds
95	2 Bytes	I	C - - W -	DPT_TimePeriodSec	0 - 65535	[W] Dimming Time 2	Time in Seconds
96	2 Bytes	I	C - - W -	DPT_TimePeriodSec	0 - 65535	[W] Dimming Time 3	Time in Seconds
97	1 Bit	I	C - - W -	DPT_Start	0/1	[W] Simple Timer	0=Deactivate; 1=Activate
98	1 Bit	O	CTR - -	DPT_Bool	0/1	[W] Warning Time (Status)	0=Deactivated; 1=Activated
99	1 Bit	I	C - - W -	DPT_Start	0/1	[W] Flashing	0=Deactivate; 1=Activate
100	1 Byte	I	C - - W -	DPT_SceneControl	0-63; 128-191	[W] Scenes/Sequences	Scene/Sequence Number
101	1 Bit	I	C - - W -	DPT_Start	0/1	[W] Start/Stop Sequence	0=Stop; 1=Start
102	1 Bit	I	C - - W -	DPT_Switch	0/1	[W] Custom On/Off 1	0=Off; 1=On
103	1 Bit	I	C - - W -	DPT_Switch	0/1	[W] Custom On/Off 2	0=Off; 1=On
104	1 Bit	I	C - - W -	DPT_Switch	0/1	[W] Custom On/Off 3	0=Off; 1=On
105	1 Bit	I	C - - W -	DPT_Switch	0/1	[W] Custom On/Off 4	0=Off; 1=On
106	1 Bit	I	C - - W -	DPT_Enable	0/1	[W] Lock	0=Unlock; 1=Lock
	1 Bit	I	C - - W -	DPT_Enable	0/1	[W] Lock	0=Lock; 1=Unlock
107	1 Bit	O	CTR - -	DPT_Switch	0/1	[W] On/Off (Status)	0=Off; 1=On
108	1 Byte	O	CTR - -	DPT_Scaling	0% - 100%	[W] Dimming Value (Status)	0 - 100%
109	2 Bytes	O	CTR - -	DPT_Value_Temp	-273,00° - 670433,28°	[TEST] Internal Temperature	°C
110, 116, 122, 128, 134, 140	1 Bit	I	C - - W -	DPT_Enable	0/1	[Ix] Input Lock	0 = Unlock; 1 = Lock
111, 117, 123, 129, 135, 141	1 Bit		CT - - - -	DPT_Switch	0/1	[Ix] [Short Press] 0	Sending of 0
	1 Bit		CT - - - -	DPT_Switch	0/1	[Ix] [Short Press] 1	Sending of 1
	1 Bit	I	CT - W - -	DPT_Switch	0/1	[Ix] [Short Press] 0/1 Switching	Switching 0/1
	1 Bit		CT - - - -	DPT_UpDown	0/1	[Ix] [Short Press] Move Up Shutter	Sending of 0 (Up)
	1 Bit		CT - - - -	DPT_UpDown	0/1	[Ix] [Short Press] Move Down Shutter	Sending of 1 (Down)

1 Bit		CT---	DPT_UpDown	0/1	[Ix] [Short Press] Move Up/Down Shutter	Switching 0/1 (Up/Down)
1 Bit		CT---	DPT_Step	0/1	[Ix] [Short Press] Stop/Step Up Shutter	Sending of 0 (Stop/Step Up)
1 Bit		CT---	DPT_Step	0/1	[Ix] [Short Press] Stop/Step Down Shutter	Sending of 1 (Stop/Step Down)
1 Bit		CT---	DPT_Step	0/1	[Ix] [Short Press] Stop/Step Shutter (Switched)	Switching of 0/1 (Stop/Step Up/Down)
4 Bit		CT---	DPT_Control_Dimming	0x0 (Stop) 0x1 (Dec. by 100%) ... 0x7 (Dec. by 1%) 0x8 (Stop) 0xD (Inc. by 100%) ... 0xF (Inc. by 1%)	[Ix] [Short Press] Brighter	Increase Brightness
4 Bit		CT---	DPT_Control_Dimming	0x0 (Stop) 0x1 (Dec. by 100%) ... 0x7 (Dec. by 1%) 0x8 (Stop) 0xD (Inc. by 100%) ... 0xF (Inc. by 1%)	[Ix] [Short Press] Darker	Decrease Brightness
4 Bit		CT---	DPT_Control_Dimming	0x0 (Stop) 0x1 (Dec. by 100%) ... 0x7 (Dec. by 1%) 0x8 (Stop) 0xD (Inc. by 100%) ... 0xF (Inc. by 1%)	[Ix] [Short Press] Brighter/Darker	Switch Bright/Dark
1 Bit		CT---	DPT_Switch	0/1	[Ix] [Short Press] Light On	Sending of 1 (On)
1 Bit		CT---	DPT_Switch	0/1	[Ix] [Short Press] Light Off	Sending of 0 (Off)
1 Bit	I	CT-W-	DPT_Switch	0/1	[Ix] [Short Press] Light On/Off	Switching 0/1
1 Byte		CT---	DPT_SceneControl	0-63; 128-191	[Ix] [Short Press] Run Scene	Sending of 0 - 63
1 Byte		CT---	DPT_SceneControl	0-63; 128-191	[Ix] [Short Press] Save Scene	Sending of 128 - 191
1 Bit	I/O	CTRW-	DPT_Switch	0/1	[Ix] [Switch/Sensor] Edge	Sending of 0 or 1
1 Byte		CT---	DPT_Value_1_Ucount	0 - 255	[Ix] [Short Press] Constant Value (Integer)	0 - 255
1 Byte		CT---	DPT_Scaling	0% - 100%	[Ix] [Short Press] Constant Value (Percentage)	0% - 100%

	2 Bytes		CT---	DPT_Value_2_Ucount	0 - 65535	[Ix] [Short Press] Constant Value (Integer)	0 - 65535
	2 Bytes		CT---	9.xxx	-671088,64 - 670433,28	[Ix] [Short Press] Constant Value (Float)	Float Value
112, 118, 124, 130, 136, 142	1 Byte	I	C--W-	DPT_Scaling	0% - 100%	[Ix] [Short Press] Shutter Status (Input)	0% = Top; 100% = Bottom
	1 Byte	I	C--W-	DPT_Scaling	0% - 100%	[Ix] [Short Press] Dimming Status (Input)	0% - 100%
113, 119, 125, 131, 137, 143	1 Bit		CT---	DPT_Switch	0/1	[Ix] [Long Press] 0	Sending of 0
	1 Bit		CT---	DPT_Switch	0/1	[Ix] [Long Press] 1	Sending of 1
	1 Bit	I	CT-W-	DPT_Switch	0/1	[Ix] [Long Press] 0/1 Switching	Switching 0/1
	1 Bit		CT---	DPT_UpDown	0/1	[Ix] [Long Press] Move Up Shutter	Sending of 0 (Up)
	1 Bit		CT---	DPT_UpDown	0/1	[Ix] [Long Press] Move Down Shutter	Sending of 1 (Down)
	1 Bit		CT---	DPT_UpDown	0/1	[Ix] [Long Press] Move Up/Down Shutter	Switching 0/1 (Up/Down)
	1 Bit		CT---	DPT_Step	0/1	[Ix] [Long Press] Stop/Step Up Shutter	Sending of 0 (Stop/Step Up)
	1 Bit		CT---	DPT_Step	0/1	[Ix] [Long Press] Stop/Step Down Shutter	Sending of 1 (Stop/Step Down)
	1 Bit		CT---	DPT_Step	0/1	[Ix] [Long Press] Stop/Step Shutter (Switched)	Switching of 0/1 (Stop/Step Up/Down)
	4 Bit		CT---	DPT_Control_Dimming	0x0 (Stop) 0x1 (Dec. by 100%) ... 0x7 (Dec. by 1%) 0x8 (Stop) 0xD (Inc. by 100%) ... 0xF (Inc. by 1%)	[Ix] [Long Press] Brighter	Long Pr. -> Brighter; Release -> Stop
	4 Bit		CT---	DPT_Control_Dimming	0x0 (Stop) 0x1 (Dec. by 100%) ... 0x7 (Dec. by 1%) 0x8 (Stop) 0xD (Inc. by 100%) ... 0xF (Inc. by 1%)	[Ix] [Long Press] Darker	Long Pr. -> Darker; Release -> Stop
	4 Bit		CT---	DPT_Control_Dimming	0x0 (Stop) 0x1 (Dec. by 100%) ... 0x7 (Dec. by 1%) 0x8 (Stop) 0xD (Inc. by 100%)	[Ix] [Long Press] Brighter/Darker	Long Pr. -> Brighter/Darker; Release -> Stop

					...		
	1 Bit		CT---	DPT_Switch	0/1	[Ix] [Long Press] Light On	Sending of 1 (On)
	1 Bit		CT---	DPT_Switch	0/1	[Ix] [Long Press] Light Off	Sending of 0 (Off)
	1 Bit	I	CT-W-	DPT_Switch	0/1	[Ix] [Long Press] Light On/Off	Switching 0/1
	1 Byte		CT---	DPT_SceneControl	0-63; 128-191	[Ix] [Long Press] Run Scene	Sending of 0 - 63
	1 Byte		CT---	DPT_SceneControl	0-63; 128-191	[Ix] [Long Press] Save Scene	Sending of 128 - 191
	1 Bit	O	CTR--	DPT_Alarm	0/1	[Ix] [Switch/Sensor] Alarm: Breakdown or Sabotage	1 = Alarm; 0 = No Alarm
	2 Bytes		CT---	9.xxx	-671088,64 - 670433,28	[Ix] [Long Press] Constant Value (Float)	Float Value
	2 Bytes		CT---	DPT_Value_2_Ucount	0 - 65535	[Ix] [Long Press] Constant Value (Integer)	0 - 65535
	1 Byte		CT---	DPT_Scaling	0% - 100%	[Ix] [Long Press] Constant Value (Percentage)	0% - 100%
	1 Byte		CT---	DPT_Value_1_Ucount	0 - 255	[Ix] [Long Press] Constant Value (Integer)	0 - 255
114, 120, 126, 132, 138, 144	1 Bit		CT---	DPT_Trigger	0/1	[Ix] [Long Press/Release] Stop Shutter	Release -> Stop Shutter
115, 121, 127, 133, 139, 145	1 Byte	I	C--W-	DPT_Scaling	0% - 100%	[Ix] [Long Press] Dimming Status (Input)	0% - 100%
	1 Byte	I	C--W-	DPT_Scaling	0% - 100%	[Ix] [Long Press] Shutter Status (Input)	0% = Top; 100% = Bottom
146	1 Byte	I	C--W-	DPT_SceneNumber	0 - 63	[Motion Detector] Scene Input	Scene Value
147	1 Byte		CT---	DPT_SceneControl	0-63; 128-191	[Motion Detector] Scene Output	Scene Value
148, 177, 206, 235, 264, 293	1 Byte	O	CTR--	DPT_Scaling	0% - 100%	[Ix] Luminosity	0-100%
149, 178, 207, 236, 265, 294	1 Bit	O	CTR--	DPT_Alarm	0/1	[Ix] Open Circuit Error	0 = No Error; 1 = Open Circuit Error
150, 179, 208, 237, 266, 295	1 Bit	O	CTR--	DPT_Alarm	0/1	[Ix] Short Circuit Error	0 = No Error; 1 = Short Circuit Error
151, 180, 209, 238, 267, 296	1 Byte	O	CTR--	DPT_Scaling	0% - 100%	[Ix] Presence State (Scaling)	0-100%
152, 181, 210, 239, 268, 297	1 Byte	O	CTR--	DPT_HVACMode	1=Comfort 2=Standby 3=Economy 4=Building Protection	[Ix] Presence State (HVAC)	Auto, Comfort, Standby, Economy, Building Protection
153, 182, 211, 240, 269, 298	1 Bit	O	CTR--	DPT_Occupancy	0/1	[Ix] Presence State (Binary)	Binary Value
	1 Bit	O	CTR--	DPT_Ack	0/1	[Ix] Presence: Slave Output	1 = Motion Detected

154, 183, 212, 241, 270, 299	1 Bit	I	C - - W -	DPT_Window_Door	0/1	[Ix] Presence Trigger	Binary Value to Trigger the Presence Detection
155, 184, 213, 242, 271, 300	1 Bit	I	C - - W -	DPT_Ack	0/1	[Ix] Presence: Slave Input	0 = Nothing; 1 = Detection from slave device
156, 185, 214, 243, 272, 301	2 Bytes	I	C - - W -	DPT_TimePeriodSec	0 - 65535	[Ix] Presence: Waiting Time	0-65535 s.
157, 186, 215, 244, 273, 302	2 Bytes	I	C - - W -	DPT_TimePeriodSec	0 - 65535	[Ix] Presence: Listening Time	1-65535 s.
158, 187, 216, 245, 274, 303	1 Bit	I	C - - W -	DPT_Enable	0/1	[Ix] Presence: Enable	According to parameters
159, 188, 217, 246, 275, 304	1 Bit	I	C - - W -	DPT_DayNight	0/1	[Ix] Presence: Day/Night	According to parameters
160, 189, 218, 247, 276, 305	1 Bit	O	C T R - -	DPT_Occupancy	0/1	[Ix] Presence: Occupancy State	0 = Not Occupied; 1 = Occupied
161, 190, 219, 248, 277, 306	1 Bit	I	C - - W -	DPT_Ack	0/1	[Ix] External Motion Detection	0 = Nothing; 1 = Motion detected by an external sensor
162, 167, 172, 191, 196, 201, 220, 225, 230, 249, 254, 259, 278, 283, 288, 307, 312, 317	1 Byte	O	C T R - -	DPT_Scaling	0% - 100%	[Ix] [Cx] Detection State (Scaling)	0-100%
163, 168, 173, 192, 197, 202, 221, 226, 231, 250, 255, 260, 279, 284, 289, 308, 313, 318	1 Byte	O	C T R - -	DPT_HVACMode	1=Comfort 2=Standby 3=Economy 4=Building Protection	[Ix] [Cx] Detection State (HVAC)	Auto, Comfort, Standby, Economy, Building Protection
164, 169, 174, 193, 198, 203, 222, 227, 232, 251, 256, 261, 280, 285, 290, 309, 314, 319	1 Bit	O	C T R - -	DPT_Switch	0/1	[Ix] [Cx] Detection State (Binary)	Binary Value
165, 170, 175, 194, 199, 204, 223, 228, 233, 252, 257, 262, 281, 286, 291, 310, 315, 320	1 Bit	I	C - - W -	DPT_Enable	0/1	[Ix] [Cx] Enable Channel	According to parameters
166, 171, 176, 195, 200, 205, 224, 229, 234, 253, 258, 263, 282, 287, 292, 311, 316, 321	1 Bit	I	C - - W -	DPT_Switch	0/1	[Ix] [Cx] Force State	0 = No Detection; 1 = Detection
322	1 Bit	I	C - - W -	DPT_Switch	0/1	[ML] Trigger	Trigger the Master Light Function
323, 324, 325, 326, 327, 328, 329, 330, 331, 332, 333, 334	1 Bit	I	C - - W -	DPT_Switch	0/1	[ML] Status Object x	Binary Status
335	1 Bit	O	C T R - -	DPT_Switch	0/1	[ML] General Status	Binary Status
336	1 Bit		C T - - -	DPT_Switch	0/1	[ML] General Switch Off: Binary Object	Switch Off Sending

337	1 Byte		CT----	DPT_Scaling	0% - 100%	[ML] General Switch Off: Scaling	0-100%
338	1 Byte		CT----	DPT_SceneControl	0-63; 128-191	[ML] General Switch Off: Scene	Scene Sending
339	1 Byte		CT----	DPT_HVACMode	1=Comfort 2=Standby 3=Economy 4=Building Protection	[ML] General Switch Off: HVAC mode	Auto, Comfort, Standby, Economy, Building Protection
340	1 Bit		CT----	DPT_Switch	0/1	[ML] Courtesy Switch On: Binary Object	Switch On Sending
341	1 Byte		CT----	DPT_Scaling	0% - 100%	[ML] Courtesy Switch On: Scaling	0-100%
342	1 Byte		CT----	DPT_SceneControl	0-63; 128-191	[ML] Courtesy Switch On: Scene	Scene Sending
343	1 Byte		CT----	DPT_HVACMode	1=Comfort 2=Standby 3=Economy 4=Building Protection	[ML] Courtesy Switch On: HVAC mode	Auto, Comfort, Standby, Economy, Building Protection
345	1 Bit		CT----	DPT_Trigger	0/1	[Heartbeat] Object to Send '1'	Sending of '1' Periodically



Join and send us your inquiries
about Zennio devices:

<http://support.zennio.com>

Zennio Avance y Tecnología S.L.
C/ Río Jarama, 132. Nave P-8.11
45007 Toledo (Spain).

Tel. +34 925 232 002.
www.zennio.com
info@zennio.com



RoHS