

# TECHNICAL MANUAL



## LUPUSC2K - VOLANSC2K AND BROWN VERSIONS

Compact radio transmitters for  
wireless NG-TRX intrusion detection  
systems

090011113



IMQ-SISTEMI DI SICUREZZA

IT08020000001624





## FOREWORD

### FOR THE INSTALLER:

Comply strictly with current standards governing the installation of electrical systems and security systems, and with the manufacturer's directions given in the manuals supplied with the products.

Provide the user with full information on using the system installed and on its limitations, pointing out that there are different levels of security performance that will need to suit the user's requirements within the constraints of the specific applicable standards. See that the user looks through the warnings given herein.

### FOR THE USER:

Check the system's operation thoroughly at regular intervals, making sure the equipment can be armed and disarmed properly.

Make sure the system receives proper routine maintenance, employing the services of specialist personnel who meet the requirements prescribed by current regulations.

Ask your installer to check that the system suits changing operating conditions (e.g. changes in the extent of the areas to be protected, change in access methods, etc...).

-----  
This device has been designed, built and tested with the utmost care and attention, adopting test and inspection procedures in accordance with current legislation. Full compliance of the working specifications is only achieved in the event the device is used solely for its intended purpose, namely:

### Compact radio transmitters for wireless NG-TRX intrusion detection systems

The device is not intended for any use other than the above and hence its correct functioning in such cases cannot be assured.

Consequently, any use of the manual in your possession for any purpose other than those for which it was compiled - namely for the purpose of explaining the product's technical features and operating procedures - is strictly prohibited.

Production processes are closely monitored in order to prevent faults and malfunctions. However, the componentry adopted is subject to an extremely modest percentage of faults, which is nonetheless the case with any electronic or mechanical product.

Given the intended use of this item (protection of property and people), we invite you to adapt the level of protection offered by the system to suit the actual situation of risk (allowing for the possibility of impaired system operation due to faults or other problems), while reminding you that there are specific standards for the design and production of systems intended for this kind of application.

**We hereby advise you (the system's operator) to see that the system receives regular routine maintenance, at least in accordance with the provisions of current legislation, and also check on as regular a basis as the risk involved requires that the system in question is operating properly, with particular reference to the control unit, sensors, sounders, dialler(s) and any other device connected. You must let the installer know how well the system seems to be operating, based on the results of periodic checks, without delay.**

Work involved in the design, installation and maintenance of systems incorporating this product should be performed only by personnel with suitable skills and knowledge required to work safely so as to prevent any accidents. It is vital that systems be installed in accordance with current legislation. The internal parts of certain equipment are connected to the mains and therefore there is a risk of electrocution when maintenance work is performed inside without first disconnecting the primary and emergency power supplies. Certain products include batteries, rechargeable or otherwise, as an emergency backup power supply. If connected incorrectly, they may cause damage to the product or property, and may endanger the operator (explosion and fire).

## EU DECLARATION OF CONFORMITY

Hereby, EL.MO. S.p.A. declares that the radio equipment LUPUSC2K - VOLANSC2K is in compliance with Directive 2014/53/EU. The full text of the EU declaration of conformity is available at the following Internet address: [elmospa.com](http://elmospa.com) – registration is quick and easy.

## DISPOSAL INSTRUCTIONS - INFORMATION FOR THE USER



IT08020000001624

In accordance with Directive 2012/19/EU on waste electrical and electronic equipment (WEEE), please be advised that the EEE was placed on the market after 13 August 2005 and must be disposed of separately from normal household waste.

This product needs batteries for correct functioning. Exhausted batteries have to be delivered to dumping grounds authorized for battery collection. The materials used for this product are very harmful and polluting if dispersed in the environment.



## 1. GENERALS

LUPUSC2K and VOLANSC2K are compact transmitters used for the control of fixtures or perimetral protections. These transmitters can be inserted in wireless systems managed by VIDOMO2K and VICOMPACT2K control units (belonging to the NG-TRX system). They can also be integrated in wireless systems controlled by other expressly compatible control unit models. Their general features can be summarized as follows:

- LUPUSC2K can transmit the state variations of magnetic contacts and of the roll-up shutter sensor wired to its terminals. LUPUSC2K is identified by the control unit as a multi-channel device; it occupies up to 3 zones for the transmission of the anomaly/alarm states of the REED magnetic contact (located on housing side), the magnetic contact wired to the terminal board and the roll-up shutter detector connected to the proper terminal. For the latter, you can properly configure the number of pulses in a time slot. The detector is fully configurable via software.
- VOLANSC2K can transmit the state variations of magnetic contacts and of the roll-up shutter detector connected via wires to its terminals. VOLANSC2K is identified by the control unit as a multi-channel device; it occupies up to 4 zones for the transmission of the anomaly/alarm states of the REED magnetic contact (located on housing side), the magnetic contact wired to the terminal board, the roll-up shutter detector connected to its related terminal and the built-in inertial piezo sensor. You can properly configure the number of pulses in a time slot and the integration for the roll-up shutter detector and the piezo sensor. The detector is fully configurable via software; only the sensitivity is adjustable on the device itself.

The plastic housing features a design in line with current style trends. **Upon request, the “M” brown version is also available.**

Note: the operative range for these devices is evaluated in open field with no obstacles, nevertheless the actual range might be reduced in case the device is installed in indoor locations with peculiar architectural features. For further details, consult the features table.

The autonomy is in the order of years of functioning, according to the features of each device.

## 2. FEATURES

Model	LUPUSC2K	VOLANSC2K
Protection class	IP3X	
IMQ certified	EN50131-2-6: grade 2, EN50131-5-3 <sup>(1)</sup>	
Environmental class	2	
Power supply voltage	3.6 V supplied by 1/2 AA 3.6 V lithium battery mod. ER14250 (supplied as standard eq.)	
Low battery threshold	2.5 V with recovery to 2.9 V.	
Minimum operating voltage	2 V for the transmitter; 2.7 V for the LED indicator.	
Power consumption @ 3.6 V	8 $\mu$ A idle, 23 mA max.	10 $\mu$ A idle, 23 mA max.
TX frequency	3 channels (configurable via browser): 868.120 MHz, 868.820 MHz, 869.525 MHz for LPD devices.	
Maximum transmitted power	25 mW	
Connection range nominal/maximum	600 / 1100 m in open field, subject to limitations depending on environmental conditions. See note.  <b>Note: the ranges refer to 99% reception of the transmitted packets, with the devices in open field at an height of 1,5 m from the ground, respectively without and with the orientation of the antenna in the best direction. The activation of the “tx boost” option, if available, increases the effective range between 10 and 30% but can significantly affect the battery life.</b>	



Model	LUPUSC2K	VOLANSC2K
Average autonomy	5 years.	4 years.
	<b>Note:</b> for the calculation, 20 total transmissions per day and a supervision transmission every 20 min are considered.	
Zones	Managed as channels. Tamper zone with NC terminals. CH1: On-board magnetic contact. CH2: NC zone for external magnetic contact. CH3: NC zone for roll-up shutter detector. Channels 2 and 3 can be configured via software application (see "9. ELECTRICAL CONNECTIONS" on page 11).	Managed as channels. Tamper zone with NC terminals. CH1: On-board magnetic contact. CH2: NC zone for external magnetic contact. CH3: NC zone for roll-up shutter detector. CH4: built-in piezo sensor. Channels 2, 3 and 4 can be configured via software application, (see "9. ELECTRICAL CONNECTIONS" on page 11).
Special operating features and controls		Piezo detector included in the printed circuit board, with impact sensitivity control and LED indicator for detected pulses. The sensitivity can be adjusted using the on-board trimmer; the integration can be set via software application.
Wiring length with 2 × 0.22 mm <sup>2</sup> cable	Roll-up shutter zone: limited to 1 m in total; magnetic contact zone: 20 m max.	
Selections	On-board REED magnetic contact enabling (on one side only).	
LED indications	Blue front LED.	Yellow front LED, used also for piezo sensor pulses visualization.
LED exclusion	Via software application.	
Sound signalling	Built-in buzzer. It can be activated for alarm also in Walk test mode.	
Supervision TX	From 5 to 240 min (default) step between two consecutive supervision transmissions. It can be modified via software application.	
TX encoding	The transmitter is provided with an identification code randomly chosen in test phase among 2 milliard combinations (2 <sup>31</sup> ).	
Transmissions for	Supervision (periodic, with step configurable via software application); tamper events for housing opening; low battery state; alarm/reset for zones with magnetic contact; alarm for roll-up shutter or piezo detector zones.	
Operating temperature	-10 / +55 °C guaranteed by manufacturer - 93 % Ur.	
Dimensions	Transmitter: W 77 × H 40 × D 26 mm; magnet: W 51 × H 9 × D 11 mm.	
Weight	58 g (battery and magnet).	
Parts supplied	4 self tapping screw 2.9 × 13, 1/2 AA 3.6 V lithium battery mod. ER14250 to be installed in the transmitter, magnet, technical manual.	

<sup>(1)</sup> grade 1 if supervision time is set as lower than 60 min; grade 2 if supervision time is set as lower than 20 min

LUPUSC2K and VOLANSC2K are accessories for VIDOMO2K and VICOMPATC2K control units (belonging to the Villeggio NG-TRX system) and other expressly compatible systems.

**These transmitters are suitable for indoor installation only. Do not install them in locations where they may be affected by condensation phenomena, for example directly on balconies.**



### 3. MECHANICAL FEATURES

View of the transmitter plastic housing and of the external magnet.

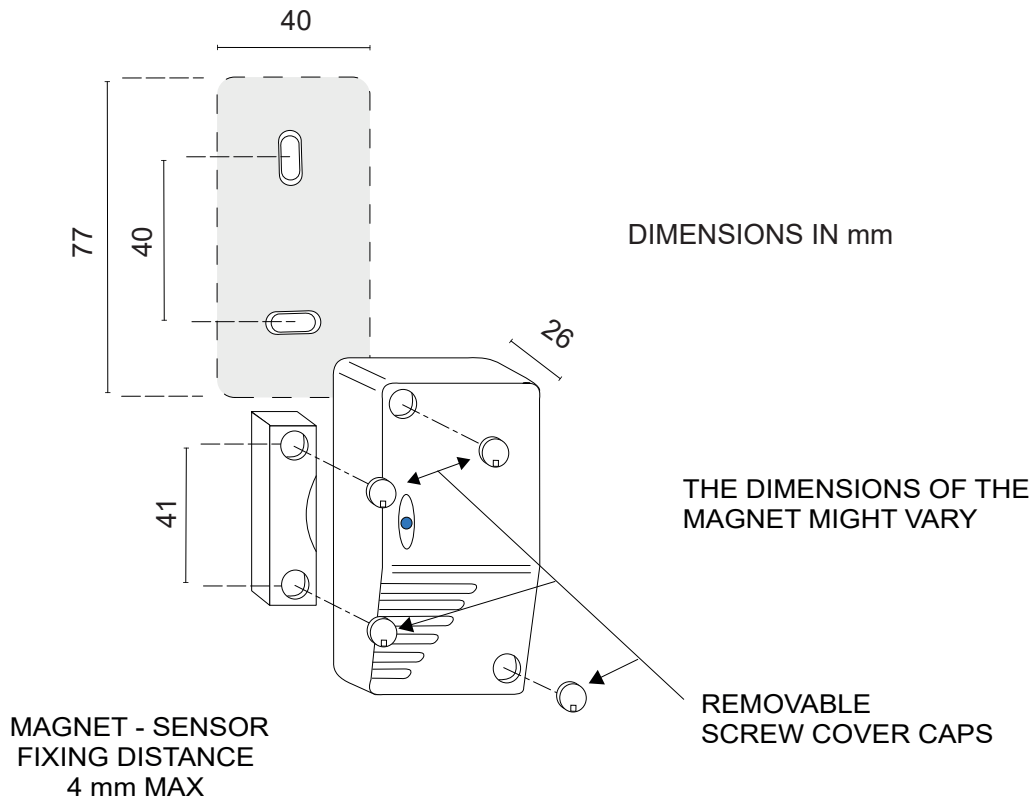

### 4. FIRST POWER-ON OR BATTERY REPLACEMENT

Particular care is required during the first power-on phase. The operations to be performed are listed in the next steps:

1. Insert the 3.6 V battery (supplied as standard equipment) checking the correct polarity.
2. Press and release the Tamper button 3-4 times.
3. Reset any memory of low battery on the control unit or on the compatible receiving device.

**WARNING:** in case you use a new battery or a battery that has not been used for a long time, a wrong indication of low battery may occur at first activations. Such issue is related to the chemical features of Lithium Thionyl Chloride batteries and it can be solved implementing the above operations.

In case of usage in low temperature locations, we suggest that you keep the battery at room temperature before insertion.



## 5. HOW TO DISTINGUISH THE DEVICES

The following picture shows the differences between the two transmitters.

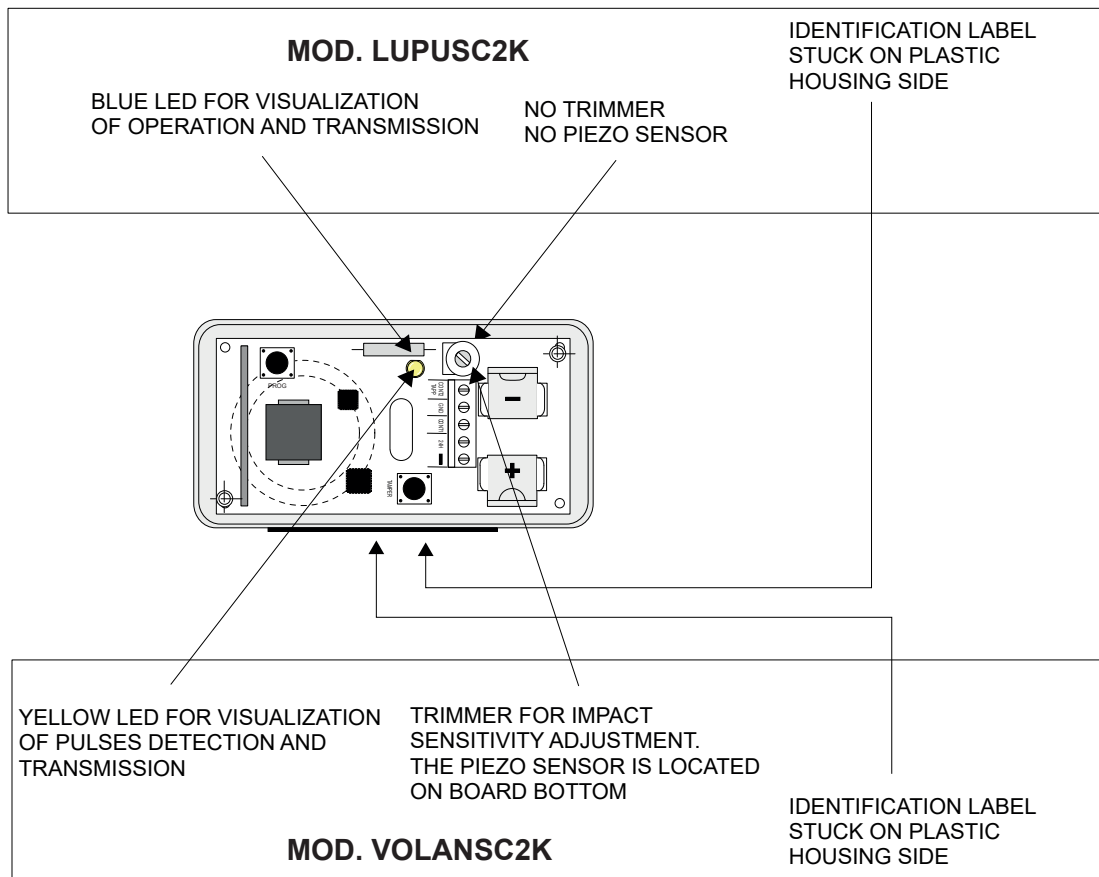



## 6. INSTALLATION



The installer shall verify that no electrostatic charges are present upon housing opening; internal electronic boards and accessory components may be damaged by such charges.  
The same care shall be used during installation, updates and maintenance procedures.

The detector installation must comply with certain rules in order to avoid performance drops due to positioning errors. Indeed, it is very important to define with the utmost care the operating area of the receiving system in which the detector is installed, the actual coverage of the sensors and the correct installation, especially in relation to the nature of the materials used in the building construction.

The following pictures show correct and wrong installation positions, objects that may attenuate RF signals and attenuation in some building materials.

### Installing situations:

**WRONG !!!**

WIRELESS CONTROL UNIT INSTALLED IN DECENTRALIZED POSITION. THE SENSORS TRANSMITTERS POSITIONED AT THE OPPOSITE SIDE OF THE HOUSE MAY BE TOO FAR. THE RADIO SIGNAL MAY BE WEAK BECAUSE OF ARCHITECTURAL OBSTACLES.

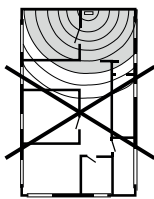

**OK**

WIRELESS CONTROL UNIT INSTALLED IN CENTRAL POSITION RESPECT TO THE SPACE TO SUPERVISE. THIS POSITION ALLOWS TO REDUCETHE DISTANCE OF PERIPHERAL DEVICES.

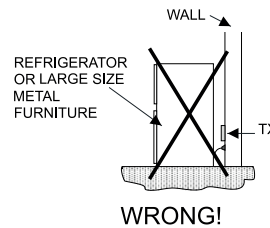
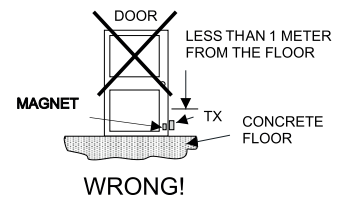
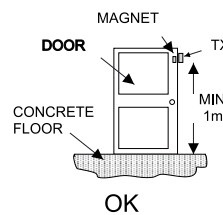
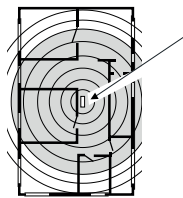

**WRONG !!!**

DON'T POSITION THE WIRELESS CONTROL UNIT BELOW GROUND LEVEL. THE RECEIVER AND THE TRANSMITTER SENSITIVITY WILL BE CONSIDERABLY REDUCED.

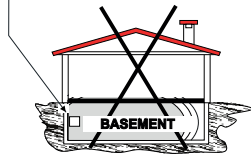

**OK**

POSITION THE WIRELESS CONTROL UNIT HIGHER THAN GROUND LEVEL. THE RECEIVER AND THE TRANSMITTER SENSITIVITY WILL TEND TOWARDS THE MAXIMUM.

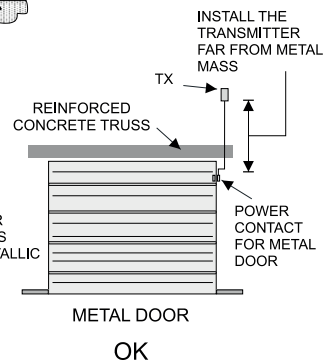
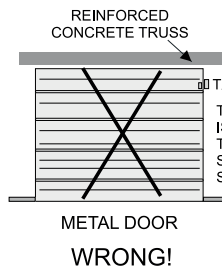
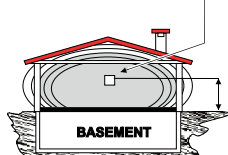

### Radio signal attenuation in some typical building materials:

90% - 100% OF FULL POWER

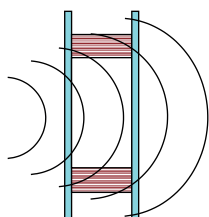

PLYWOOD PLASTERBOARDS WALLS

65% - 95% OF FULL POWER

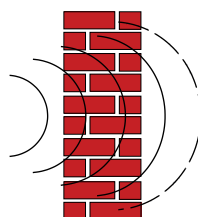

SOLID OR HOLLOW BRICKS

10% - 70% OF FULL POWER

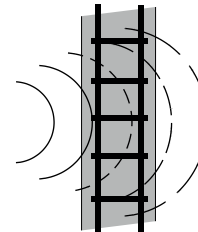

REINFORCED CONCRETE OR PLASTER AND STEEL WALLS



Objects that can modify and/or reduce the range (example with Villeggio NG-TRX control unit):

THE CONTROL UNIT CAN ALSO MANAGE ACCESSORY DEVICES BELONGING TO STANDARD VILLEGGIO AND HELIOS SERIES

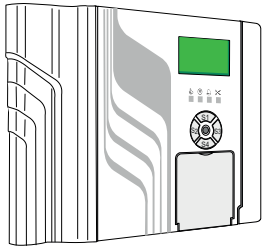

VIDOMO2K OR VICOMPACT2K CONTROL UNIT

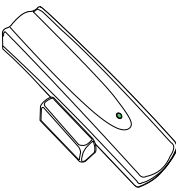

OUTDOOR TRANSMITTER WITH BUILT-IN MAGNETIC CONTACT MOD. VIRGO2K

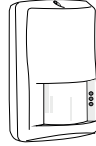

DT DETECTOR MOD. CONDOR2K

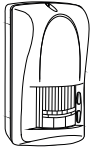

IR DETECTOR MOD. SCORPIO2K

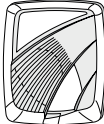

SELF-POWERED WIRELESS SIREN WITH LITHIUM BATTERY PACK MOD. GAIA2K

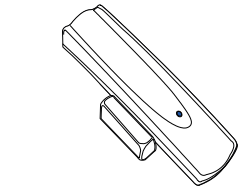

TRANSMITTER WITH BUILT-IN MAGNETIC CONTACT, PIEZO SENSOR AND INPUTS FOR EXTERNAL MAGNETIC CONTACT AND ROLL-UP SHUTTER SENSORS MOD. LUPUS2K

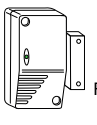

TRANSMITTER WITH BUILT-IN MAGNETIC CONTACT, PIEZO SENSOR AND INPUT FOR EXTERNAL ROLL-UP SHUTTER SENSOR MOD. VOLANSC2K

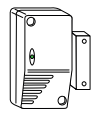

TRANSMITTER WITH BUILT-IN MAGNETIC CONTACT AND INPUT FOR EXTERNAL ROLL-UP SHUTTER SENSOR MOD. LUPUSC2K



BIDIRECTIONAL REMOTE CONTROL MOD. ATLANTE2K

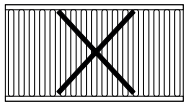

METAL GRIDS AND REINFORCED CONCRETE WALLS

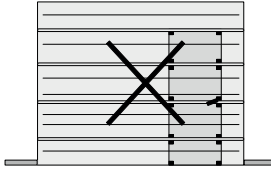

METAL DOORS

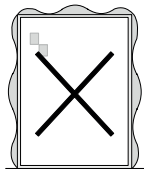

MIRRORS

The device is not suitable for installation on doors/windows that are opened very often (more than 100 activations each day), since this may cause a great amount of radio transmissions and the premature battery fail.

### 7. COVERAGE AND SENSITIVITY

Before installing the VOLANSC2K sensor, carefully consider the maximum sensitivity that can be obtained based on the surface to be protected with its integrated piezo sensor. For this purpose it is useful to refer to the following table:

Surface material	Radius
Brick wall	1 m
Steel	3 m
Wood	3 m
Concrete	30 cm
Plywood	3 m
Glass *	3 m

\* The glass test was conducted after sticking the sensor with very adhesive double-sided tape. When installed on glass surfaces, the VOLANSC2K transmitter is suitable for detecting impact but not for cut and perforations.

Installation of VOLANSC2K transmitter on a glass panel:

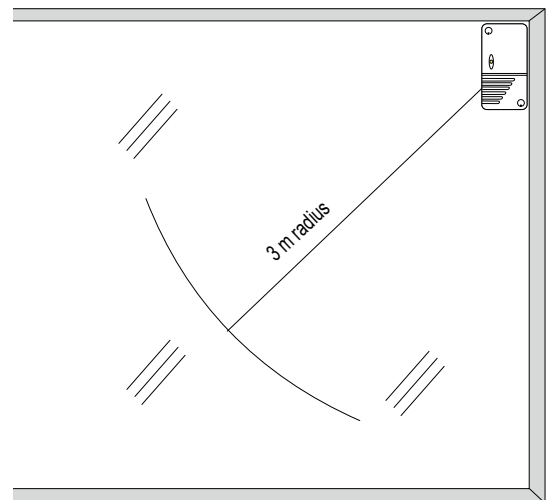





## 8. MOUNTING

### 8.1 Housing drilling for cable passing

The following picture shows the sequence of operations to be performed to drill the device housing for cable passing.

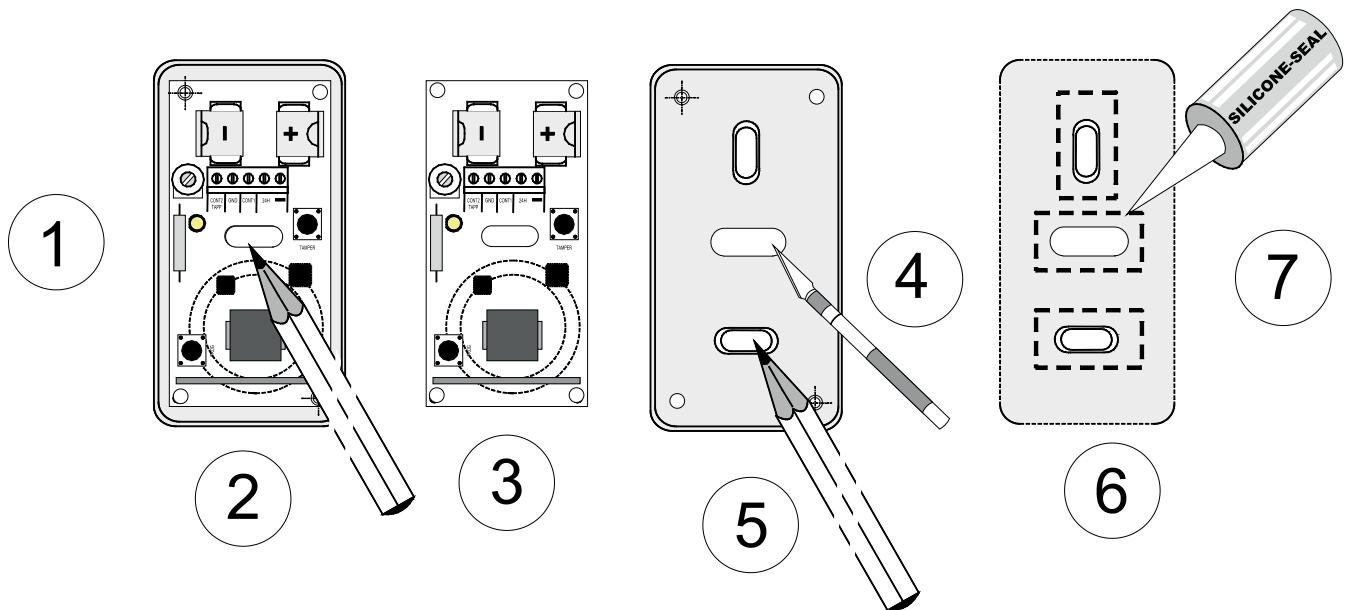

1. Open the device and store the cover in a safe place.
2. Draw the shape of the oval hole (located below the terminal board) on the housing bottom, by following its edge with a thin-tip pencil.
3. Remove the electronic board and store it. If you are using VOLANSC2K, be careful not to damage the piezo section on the bottom side of the board.
4. Cut the housing bottom with a suitable tool. Make a bigger slot than the sketch you have drawn.
5. Lean the housing bottom against the wall in the installation position. Mark the holes if you need to use screws to fix the housing to the surface.
6. Perform the fixing; feed any required cable.
7. Pour a drop of silicone around the eyelets on the bottom—e.g. the cable input hole and the fixing holes—in order to provide an isolating seal against accidental moisture penetration.

After these operations, proceed with wirings, powering, software configuration. Close the housing making sure to fit the closing spring belonging to the Tamper protection microswitch properly in place. Finally, move ahead with testing.

Example of LUPUSC2K transmitter mounting inside the housing of a roll-up shutter.

One of the possible fixing positions is indicated in the picture on the right.

Search the best position in order to easily replace the battery when needed: a possible position could be the external side of the box.

**If you need an additional fixing support, avoid using a metal one in order not to worsen the radio signal.**

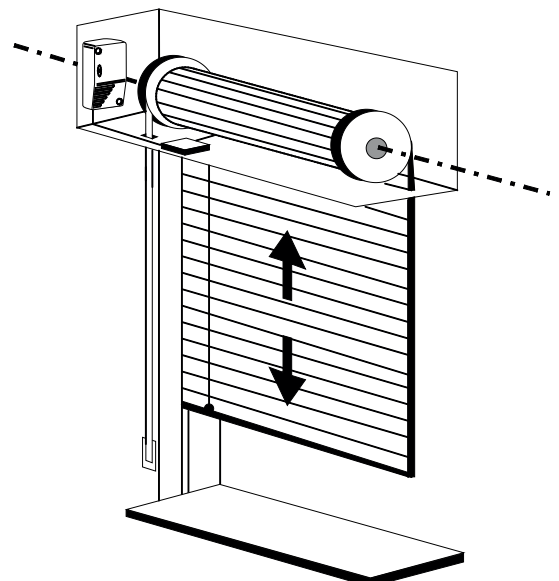



## 8.2 Protection against removal from mounting surface

Compliance with EN 50131 regulation grade 2 requires that the device is protected against removal from the mounting surface.

Install KSAS1013 kit (green) before fixing the detector base to the fixture.

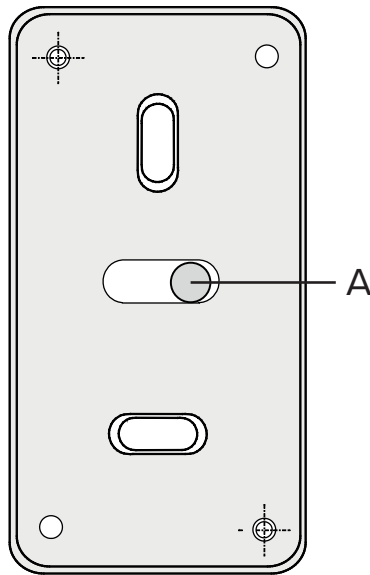

- drill a 3-mm-diameter hole on area A
- cut the cable connector off
- feed the cable (from the free end) in the drilled hole

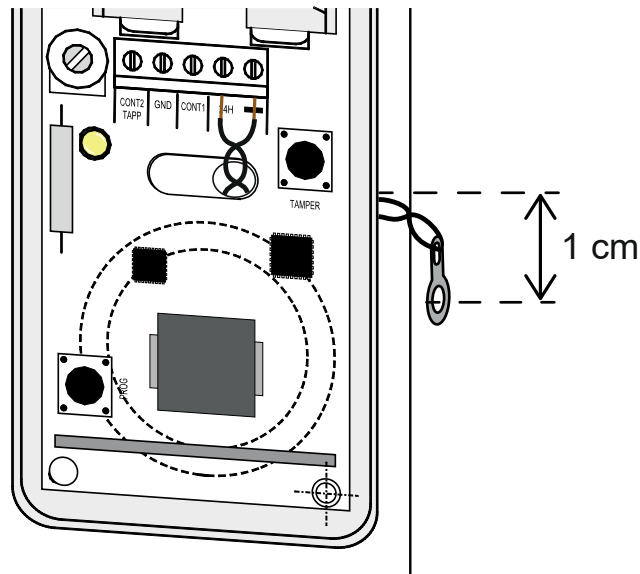

- fix a S4 dowel (supplied) at a height of 1 cm from the hole
- fix the eyelet to the dowel
- fix the detector base to the fixture
- connect the wires to the 24H terminals on board



## 9. ELECTRICAL CONNECTIONS

### 9.1 Board general view

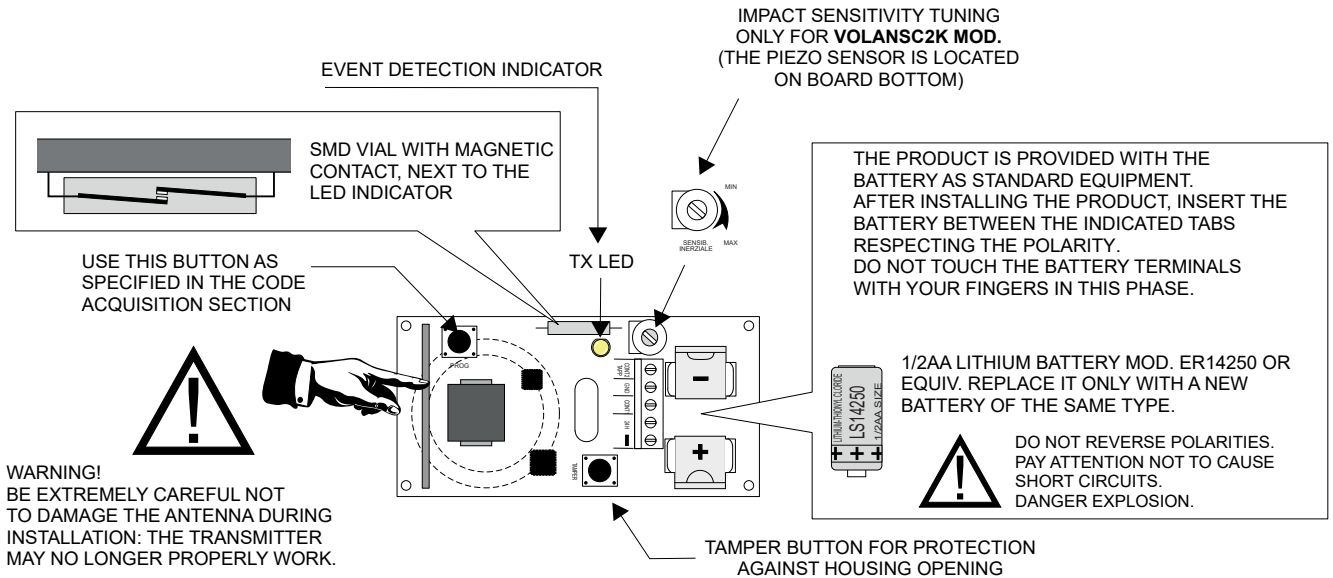

### 9.2 LUPUSC2K general connections

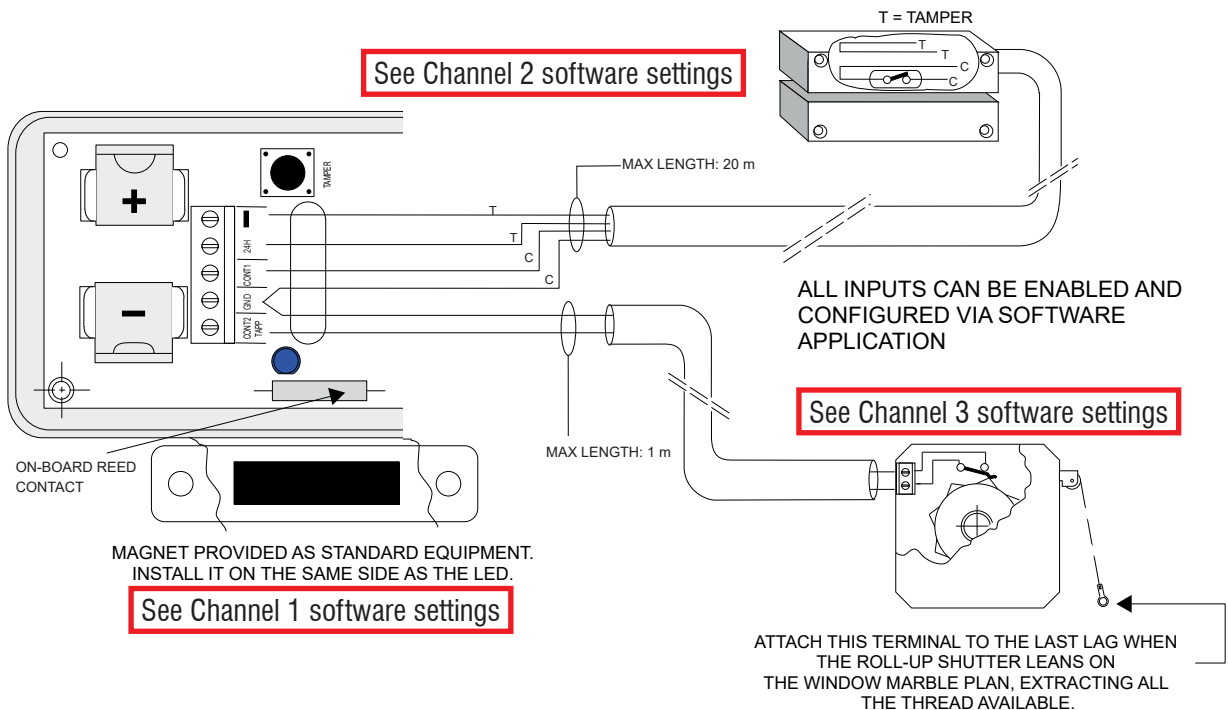

**Note:** in order to ensure the product certification, it is necessary to connect the Tamper protection lines of the external magnetic contact and of the roll-up sensor to the "24H" terminal.



### 9.3 Allowed wiring types for LUPUSC2K model

Using the software application, you can fully configure wiring types in order to optimize the device operations for the required functions. The following screen is displayed in the “Zones” page, “Radio devices NG-TRX” tab corresponding to the selected zone. For this zone, the specific model and other informations concerning the type of alarm generated and the firmware version are displayed.

Options sensor LUPUSC2K

Enable Led

**Channel 1**  Buzzer activation functions 06. Zone 6 Jump Magnetic input on board

**Channel 2**  Buzzer activation functions 07. Zone 7 Jump Input 1 Magnetic Time 15 s Impulse number 4

**Channel 3**  Buzzer activation functions 08. Zone 8 Jump Input 2 Fast Time 15 s Impulse number 4

The “Enable Led” selection allows you to enable/disable the on-board LED according to the operational necessities. Flag the “Buzzer activation functions” checkbox to apply to the specific channel the functional settings concerning the internal buzzer that have been configured in the “Buzzer activation” selection displayed in the “Options NG-TRX” area. During the detector learning phase, the channels are assigned to three consecutive zones; however, you can immediately avoid memorizing an unused channel or you can disconnect such a channel from the browser application in order to occupy less zones.

The software menu can also be used to move the channels to different zones, e.g. to group all roll-up shutter sensors on consecutive zones. Click on the triangle located at the right of the zone number and choose a different zone from the list, then click on the “Jump” button in order to move the channel (and the zone name) to the selected zone. In case the zone is already occupied by other devices, the software application will signal the code conflict.

**Channel 1** 06. Zone 6 Jump Magnetic input on board

**Channel 2** 07. Zone 7 Jump Input 1 Magnetic Time 15 s Impulse number 4

**Channel 3** 08. Zone 8 Jump Input 2 Fast Time 15 s Impulse number 4

You can configure the type for channels 2 and 3 independently, choosing between magnetic and roll-up shutter type. For the latter, you can define the number of pulses and the timeout for a valid alarm detection.

**Timeout (s)** = 5, 10, 15 (default), 20.

**Number of pulses** = 1, 2, 4 (default), 8.

After configuring the settings, write the configuration to the control unit and then perform the functional test.



9.4 VOLANSC2K general connections

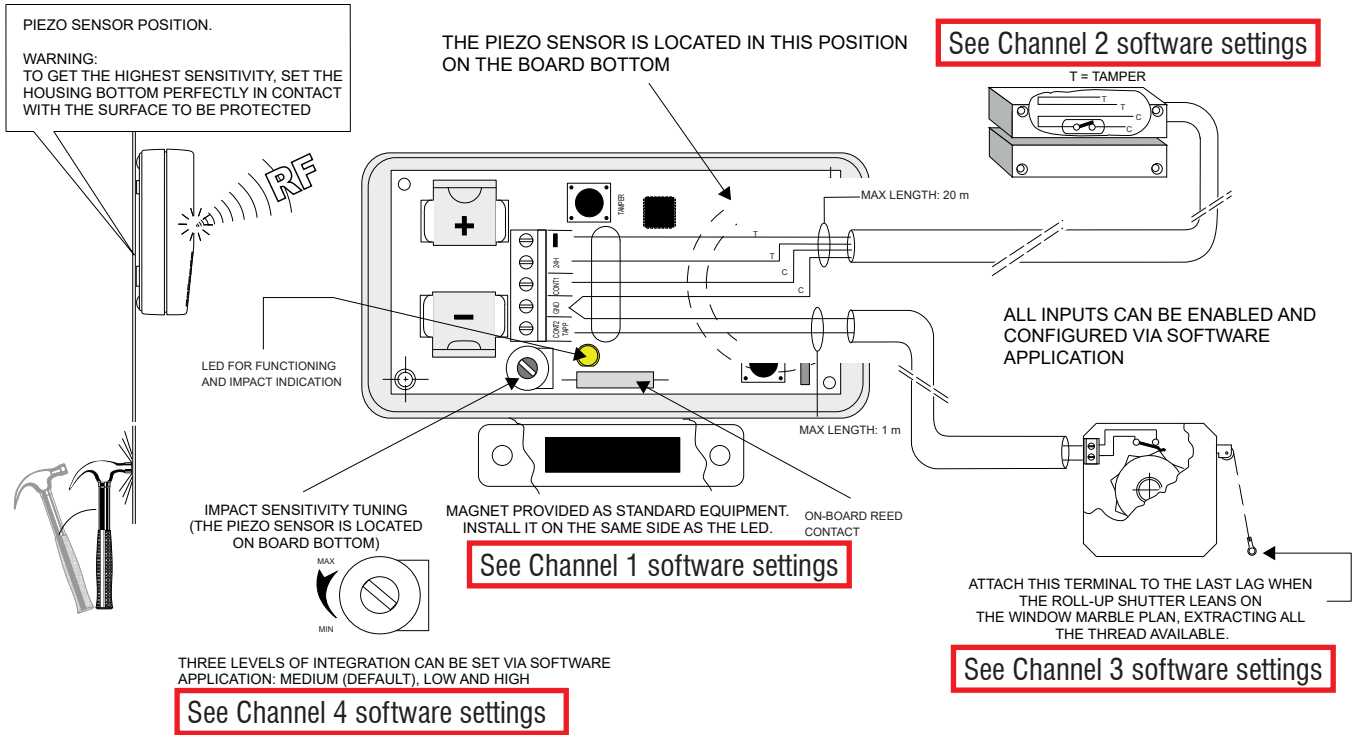

**Note:** in order to ensure the product certification, it is necessary to connect the Tamper protection lines of the external magnetic contact and of the roll-up sensor to the transmitter “24H” terminal.

9.5 Allowed wiring types for VOLANSC2K model

Using the software application, you can fully configure wiring types in order to optimize the device operation in the required functions. The following screen is displayed in the “Radio devices NG-TRX” tab corresponding to the selected zone. For this zone, the specific model and other informations concerning the type of alarm generated and the firmware version are displayed.

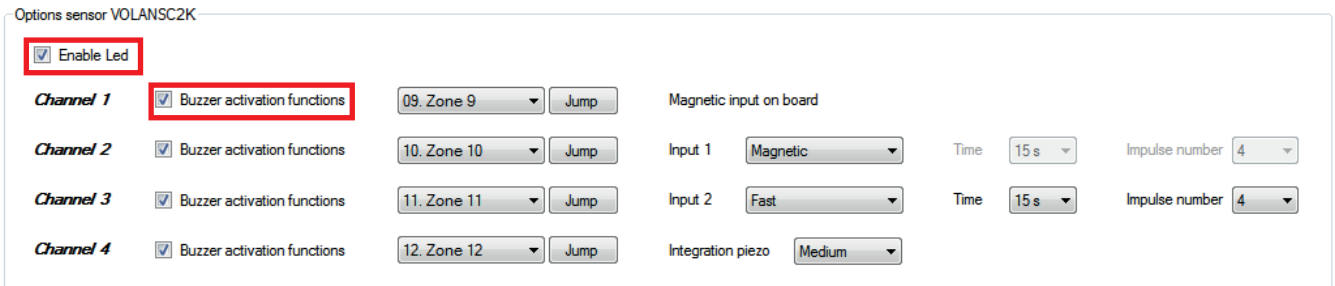

The “**Enable Led**” selection allows to enable/disable the on-board LED according to the operational necessities. The “Walk Test” and “Learning” phase indications will be visualized even when the LED is not enabled. Checking the “**Buzzer activation functions**” allows to apply to the specific channel the functional settings of the internal buzzer that have been configured in the “**Buzzer activation**” selection displayed in the “**Options NG-TRX**” tab right above this one. During the detector learning phase, the channels are assigned to four consecutive zones; however, you can immediately avoid memorizing an unused channel or you can disconnect such a channel from the browser application in order to occupy less zones. The software menu can also be used to move the channels to different zones, e.g. to group all roll-up shutter sensors on consecutive zones. Click on the triangle located at the right of the zone number and choose a different zone from the list, then click on the “**Jump**” button in order to move the channel (and the zone name) to the selected zone. In case the zone is already occupied by other devices, the software application will signal the code conflict.



<b>Channel 1</b>	09. Zone 9	Jump	Magnetic input on board			
<b>Channel 2</b>	10. Zone 10	Jump	Input 1	Magnetic	Time 15 s	Impulse number 4
<b>Channel 3</b>	11. Zone 11	Jump	Input 2	Fast	Time 15 s	Impulse number 4
<b>Channel 4</b>	12. Zone 12	Jump	Integration piezo	Medium		

You can configure the type for channels 2 and 3 independently, choosing between magnetic and roll-up shutter type. For the latter, you can define the number of pulses and the timeout for valid alarm detection.

**Timeout (s)** = 5, 10, 15 (default), 20.

**Number of pulses** = 1, 2, 4 (default), 8.

The built-in inertial sensor response can be adjusted based on the material and the fixing position; the sensitivity can be adjusted using the trimmer indicated in the electrical connection picture; the pulse integration can be set via software application, choosing among 3 levels: Medium (default), Low, High.

The picture refers to default settings.

After configuring the settings, write the configuration in the control unit and then perform the functional test.

## 10. CODE MEMORIZATION

**Note:** during the code acquisition phases, keep in mind that the control unit identifies LUPUSC2K and VOLANSC2K as multi-channel devices.

The following procedure allows to memorize the transmitter to a Villeggio NG-TRX control unit.

- Power on the transmitter by inserting the battery. Respect the polarity as indicated in the printed board and in this manual.
  - Enter the programming menu by typing the installer code on a system keypad.
  - Press "OK", then use the arrow buttons to browse to "**Learn radio det.**".
  - Press "OK", then either use the arrow buttons to browse through the available zones or type a zone address.
  - Press "OK", then press 1 to store the code to the control unit. Press "OK" again.
  - Immediately press the "PROG" button of the transmitter (next to the magnet), and keep it pressed for at least 3 seconds.
  - A double beep of the internal buzzer and a double blink of the transmitter LED signal a successful memorization.
  - The control unit also beeps twice to confirm the successful memorization.
  - The display shows the channels identified by the control unit in this sequence:  
CH1 with Alarm/Reset, referring to the built-in magnetic contact,  
CH2 with Alarm/Reset, referring to the magnetic contact to be wired,  
CH3 with Alarm event, referring to the roll-up shutter detector to be wired,  
CH4 with Alarm event, referring to the built-in piezo sensor (**available only for the VOLANSC2K model**).
- For each channel, press "OK" for confirmation or # to switch to the next channel, up to the last available channel.
- Note:** during the acquisition phase, you can choose between the acquisition of either all or only some of the channels. After a "partial" acquisition, the channels cannot be added to the control unit manually, but only using BrowserOne.
- If the memorization fails, the internal buzzer plays a long, deep beep. Restart from point 6.
  - Exit the programming menu, pressing "OK" any time you are asked to save/memorize the new settings.
  - Use BrowserOne with the module for your NG-TRX control unit to read the configuration, change the settings for the transmitter, then write the modified configuration. See the next chapter.
  - The new settings will be operative from after the next transmission.
  - Open and close the window or the roll-up shutter (or generate an inertial alarm in case you are using the VOLANSC2K detector) to test that the transmitter is working. Since the internal buzzer is usually disabled (unless you activated it via browser in order to ease the test), the only indication is given by the LED turning on.

**Note:** The device will not be memorized in case of low battery.



## 11. TRANSMITTER CONFIGURATION VIA SOFTWARE

The transmitter can be fully programmed by using BrowserOne v. 3.4.7 or higher with control unit module v. 8.4.11 or higher. The control unit firmware must be 8.2.0.0 or higher.

See the specific technical documentation for information on other expressly compatible control unit models.

Perform the following operations:

- Start the connection as explained in the programming manual of the control unit.
- Read the current configuration, open the “Zones” page and identify the number of the zone that is assigned the acquired code of the transmitter.

- Still in the Zones page, open the “Radio devices NG-TRX” tab.

Select to increase the power of the RF section.

**WARNING: this causes a decrease in battery duration.** Use only when the range is not sufficient.

On the side of the page concerning the NG-TRX wireless devices, some useful notes are displayed for the correct configuration of the detector, depending on the selection of the “Supervision interval” and the “Tx Boost” function.

In the bottom page you can find the specific section for the transmitter channels configuration, described in chapter “9. ELECTRICAL CONNECTIONS” on page 11.





Open the “System options” page, “Options NG-TRX” tab, where the general options of the NG-TRX devices are available. Here you can select the settings that also involve the LUPUSC2K and VOLANSC2K transmitters.

Receiving multichannel

On  
 Off

Selection of the multi-channel reception (3 channels), also involving the default/preferential channel selection and the transmission strategy. In case the function is active but communication with the control unit is not possible, the device will use one of the other two remaining channels. For more details see “12.4 Multi-channel reception and strategy” on page 17.

The default channel shall be set by the installer, otherwise it is Ch1.

**Note:** the system uses the preferred channel based on the interference level; if there is no interference, the default channel is used. Each channel change will be recorded in the event log.

Options NG-TRX

Default channel: Channel 1

Supervision interval: 240 minutes

1  Delay supervision anomaly  
 Enable two-factor authentication for Remote Controls

2  Delay low battery signaling

3  Enable detection RF interference

4  RF Interference as Tamper

Remote range NGTRX

min \_\_\_\_\_ MAX

Transmissions of NG-TRX command

Common supervision for all system devices, except remote controls; if necessary, it can be modified for each device.

240 minutes  
240 minutes  
120 minutes  
60 minutes  
20 minutes  
5 minutes

**NOTE:** the selected supervision interval directly affects battery life. More information can be found in the manual of each product.

The listed options are valid for all NG-TRX devices, except remote controls:

- 1. Delay supervision anomaly:** NG-TRX devices generate the supervision failure event 6 supervision cycles later. Example: if the default supervision timer is set to 240 minutes and the delay function is active, the supervision anomaly is generated 24 hours later (240 minutes × 6).
- 2. Delay low battery signalling:** if active, the devices run more thorough controls before sending the low battery signal.
- 3. Enable detection RF interference:** this selection allows to detect interferences in the three 868 MHz channels and to generate the event log. The interference detection on the preferred channel involves the transition to an other channel if the same interference has already been detected and logged in the last 48 hours. The general options selection about the 434 MHz interference detection does not concern NG-TRX devices.
- 4. RF Interference as Tamper:** select this function to use an RF interference event to generate a tampering event, along with the resulting management.





## 12. OPERATING MODES

---

### 12.1 Walk test - System test

The Walk test condition can be activated via keypad, from the SYSTEM TEST » ZONE TEST menu. The beginning of the operating mode is indicated by three beeps of the internal buzzer and by the LED blinking. After exiting the Walk test mode, the internal buzzer will enter operating mode, whose configuration depends on browser programming.

### 12.2 Operation

In operative conditions, the detector only uses the cover LED, for both alarm or tamper conditions. These conditions can also be indicated by the internal buzzer if it has been programmed for alarm or for alarm and reset. The buzzer is disabled by default.

### 12.3 Supervision

In case you have made some changes in supervision times (with subsequent memorization in control unit), they will be updated to the set values upon the first transmission. Therefore, if some devices are temporarily not powered, the control unit will signal them considering a different supervision time than the one just set.

After the next power-on of the devices, the supervision time will be updated to the set value. In case of subsequent detector power failure, the system will keep the current supervision time.

In case you change the supervision time after a control unit reset, it will be updated at the first transmission.

Namely, immediately after the main reset, the supervision time that will be considered is the current one; any devices that are not aligned within that time will enter the missed supervision state.

### 12.4 Multi-channel reception and strategy

It can be set in the NG-TRX Options page.

If the function is ACTIVE (default), the control unit is able to receive on all channels; if it is not active, the control unit receives on one channel at a time. It is possible to increase reliability, when there are interferences on a specific channel, by turning off the multi-channel reception.

**Note:** We suggest that you disable the Multi-channel reception when you are aware of the existence of radio interference on one or more channels. In this case the control unit will receive only on the default/preferential channel, although the detector performs transmission attempts on all channels.

### 12.5 Default/preferential channel

#### **Default channel**

In case of radio interferences, it is recommended to set the most free channel as the default channel (you can check it through the monitoring functions on the browser and control unit).

In case of strong interferences, it is possible to increase the reliability of the communication by disabling the multi-channel reception.

#### **Preferential channel**

The variation of the preferential channel is performed in case of interference detection. The control unit can change the preferential channel independently of the activation of multi-channel reception mode.



### 13. BATTERY REPLACEMENT AND DISPOSAL

The LUPUSC2K and VOLANSC2K detectors use a Lithium 3.6 V 1.2 Ah battery mod. ER14250 or LS1425 (1/2AA). Replace this battery only with a new one of the same model. Observe the following insertion instructions:

1. Remove the low battery.
2. Press and release 3-4 times the Tamper button to discharge any charged capacitors.
3. Check the distance of the battery clip tabs. In idle conditions, they have to take an inclination similar to that shown in the figure. The distance between the two tabs should be about 25 mm; if more, you will have to push them inward to obtain the indicated distance.

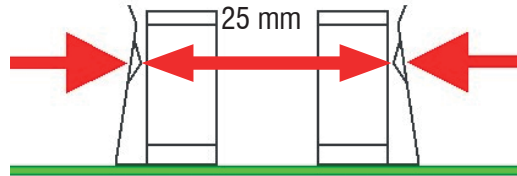

4. The correct position of the tabs allows an excellent electrical contact and avoids possible and erroneous signalling of low battery.
5. Insert the new battery. Pay attention to the polarity.
6. Reset any low battery memories in control unit or in the compatible receiving device.

Dispose of the old battery in full compliance with the current regulations, using the appropriate containers. The materials used are highly polluting and harmful if released to the environment.

**14. TABLE OF CONTENTS**

1. GENERALS .....	3
2. FEATURES .....	3
3. MECHANICAL FEATURES .....	5
4. FIRST POWER-ON OR BATTERY REPLACEMENT .....	5
5. HOW TO DISTINGUISH THE DEVICES .....	6
6. INSTALLATION .....	7
7. COVERAGE AND SENSITIVITY .....	8
8. MOUNTING .....	9
8.1 Housing drilling for cable passing .....	9
8.2 Protection against removal from mounting surface .....	10
9. ELECTRICAL CONNECTIONS .....	11
9.1 Board general view .....	11
9.2 LUPUSC2K general connections .....	11
9.3 Allowed wiring types for LUPUSC2K model .....	12
9.4 VOLANSC2K general connections .....	13
9.5 Allowed wiring types for VOLANSC2K model .....	13
10. CODE MEMORIZATION .....	14
11. TRANSMITTER CONFIGURATION VIA SOFTWARE .....	15
12. OPERATING MODES .....	17
12.1 Walk test - System test .....	17
12.2 Operation .....	17
12.3 Supervision .....	17
12.4 Multi-channel reception and strategy .....	17
12.5 Default/preferential channel .....	17
13. BATTERY REPLACEMENT AND DISPOSAL .....	18
14. TABLE OF CONTENTS .....	19

LUPUSC2K - VOLANSC2K - Compact radio transmitters for wireless NG-TRX intrusion detection systems  
TECHNICAL MANUAL - August 2018 edition

090011113

The information and product features herein are not binding and may be changed without prior notice.

**EL.MO. SpA** Via Pontarola, 70 - 35011 Campodarsego (PD) - Italy  
Tel. +390499203333 - Fax +390499200306 - Technical Ass. +390499200426 - [www.elmospa.com](http://www.elmospa.com) - [international@elmospa.com](mailto:international@elmospa.com)