

## Modbus Server

Mitsubishi Electric Centralized Controller TCP/ IP XML

Gateway for integration of Mitsubishi Electric City Multi air conditioning system into  
Modbus (RTU and TCP) systems

### USER MANUAL

Issue date: 05/2021 r1.3 ENGLISH

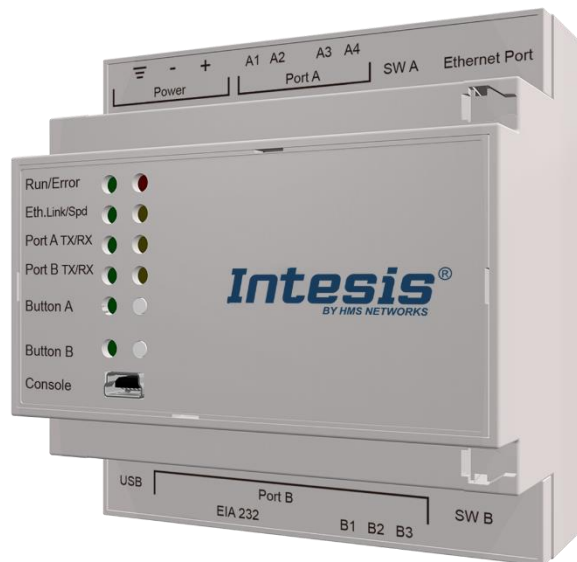

## Important User Information

### Disclaimer

The information in this document is for informational purposes only. Please inform HMS Industrial Networks of any inaccuracies or omissions found in this document. HMS Industrial Networks disclaims any responsibility or liability for any errors that may appear in this document.

HMS Industrial Networks reserves the right to modify its products in line with its policy of continuous product development. The information in this document shall therefore not be construed as a commitment on the part of HMS Industrial Networks and is subject to change without notice. HMS Industrial Networks makes no commitment to update or keep current the information in this document.

The data, examples and illustrations found in this document are included for illustrative purposes and are only intended to help improve understanding of the functionality and handling of the product. In view of the wide range of possible applications of the product, and because of the many variables and requirements associated with any particular implementation, HMS Industrial Networks cannot assume responsibility or liability for actual use based on the data, examples or illustrations included in this document nor for any damages incurred during installation of the product. Those responsible for the use of the product must acquire sufficient knowledge in order to ensure that the product is used correctly in their specific application and that the application meets all performance and safety requirements including any applicable laws, regulations, codes and standards. Further, HMS Industrial Networks will under no circumstances assume liability or responsibility for any problems that may arise as a result from the use of undocumented features or functional side effects found outside the documented scope of the product. The effects caused by any direct or indirect use of such aspects of the product are undefined and may include e.g. compatibility issues and stability issues.

Gateway for integration of Mitsubishi Electric City Multi air conditioning systems into Modbus (RTU and TCP) systems.

<b>ORDER CODE</b>	<b>LEGACY ORDER CODE</b>
INMBSMIT050C000	ME-AC-MBS-50
INMBSMIT100C000	ME-AC-MBS-100

## INDEX

1	Description .....	5
	Introduction .....	5
	Functionality.....	6
	Gateway's capacity.....	6
2	Modbus interface.....	7
	Functions supported .....	7
	Modbus RTU.....	7
	Modbus TCP .....	7
	Modbus Address Map.....	7
	2.1.1 Centralized Controller signals.....	7
	2.1.2 City Multi Group signals.....	9
3	Connections .....	13
	Power device .....	14
	Connect to Mitsubishi's Centralized Controller(s). .....	14
	Connection to Modbus.....	14
	3.1.1 Modbus TCP.....	14
	3.1.2 Modbus RTU.....	14
	Connect to PC (Configuration tool).....	14
4	Set-up process and troubleshooting .....	15
	Pre-requisites.....	15
	Intesis MAPS. Configuration & monitoring tool for Intesis.....	15
	4.1.1 Introduction .....	15
	4.1.2 Connection.....	15
	4.1.3 Configuration tab .....	16
	4.1.3.1 Mitsubishi Electric Configuration .....	16
	4.1.4 Signals .....	22
	4.1.5 Sending the configuration to Intesis .....	22
	4.1.6 Diagnostic.....	23
	Set-up procedure .....	24
5	Electrical & Mechanical Features.....	25
6	Dimensions .....	26

# 1 Description

## Introduction

This document describes the integration of Mitsubishi Electric’s City Multi series air conditioning systems into Modbus compatible devices and systems using the Intesis Modbus Server to Mitsubishi Electric’s Centralized Controller communication gateway.

The aim of this integration is to monitor and control Mitsubishi Electric City Multi air conditioning system, remotely, from your Control Center using any commercial SCADA or monitoring software that includes a Modbus Master driver (RTU and/or TCP). To do it so, Intesis performs as a Modbus Server, allowing poll and write requests from any Modbus master device.

This integration requires the Mitsubishi Electric City Multi AC system to be equipped with a Mitsubishi Electric’s Centralized Controller for MNET (G-50A, GB-50A, AG-150A, EB-50, EW-50 or AE200 and newer). This Centralized Controller offers the signals of the City Multi AC system through XML protocol at its Ethernet port, which is accessed by the Intesis. Every Centralized Controller from Mitsubishi Electric allows access to the signals of up to 50 City Multi indoor units groups, no matter the number of outdoor units installed. In the Centralized Controller, the control unit is the group, each of which can have from 1 to 16 associated indoor units.

MNET’s Centralized Controller is offered by Mitsubishi Electric. Each different model has different features (some incorporate just a blind cover, others have a keyboard and an LCD panel). Mitsubishi Electric’s Expansion Controllers can be connected to the MNET Centralized Controller in order to extend to more than 50 indoor unit groups (50 additional groups for each Expansion Controller). Expansion Controllers in MNET system is also supported by Intesis.



**NOTE:** Please take into account that most Mitsubishi Electric Centralized Controllers require a software license, PC-Monitoring license (SW-Mon), that must be purchased together with the controller in order that the XML interface is active and can be used by the Intesis.

Intesis needs to be configured using Intesis MAPS software configuration tool. In the software, Modbus and MNET’s Centralized Controller parameters must be configured and downloaded to the Intesis.

Up to 50 indoor unit groups (1 Centralized Controller) or 100 indoor unit groups (2 Centralized Controllers) are supported, depending on the version of the gateway.

This document assumes the user is familiar with Modbus and Mitsubishi Electric technologies and technical terms.

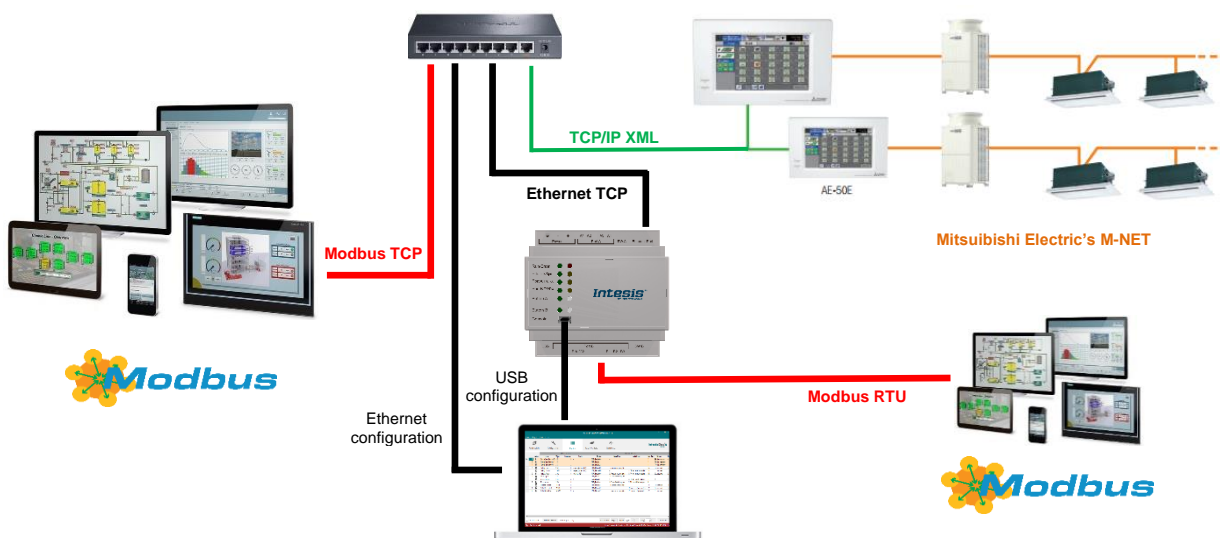

**Integration of Mitsubishi's Centralized Controller into Modbus TCP / Modbus RTU control systems**

## Functionality

Intesis™ continuously polls (reads) all the signals of the Centralized Controller groups and maintains the updated values to be served in Modbus.

When a write is done from Modbus in a gateway's Modbus writeable address, the corresponding command is sent to the City Multi associated signal.

In the continuous polling process of the Centralized Controller, if there is no answer, it is indicated with a virtual signal of communication error for the Centralized Controller. In the same way, there is a communication error virtual signal for each of the City Multi groups, which normally will be activated if this group is not configured in the Centralized Controller.

The IP address and communication parameters (polling cadence, connection timeout, ...) of every Centralized Controller to connect to must be also configured using Intesis MAPS configuration tool, as well as Modbus TCP or RTU communication parameters.

From the configuration tool, it is also possible to scan the Centralized Controller for available groups and thereafter add them in the configuration, so that they are continuously polled.

## Gateway's capacity

Intesis capacity is listed below:

Element	Max.	Notes
Number of MNET Centralized Controllers	2	Number of independent centralized controllers (if expansion controllers are present, each expansion controller counts as a single centralized controller)
Number of City Multi groups	100	50 groups for each centralized controller are supported
Max number of variables per group	38	Number of available signals will vary according to unit type
Max number of variables per Centralized Controller	1926	26 global signals (error signaling & batch control) + 38 signals/group x 50 groups

There are 2 different models of *Intesis™ Modbus Server – Mitsubishi Electric Centralized Controller* with different capacity. The table above shows the capacity for the top model (with maximum capacity).

The 2 different models allow integrating respectively: 1 or 2 Centralized Controllers.

Their **order codes** are:

- **INMBSMIT050C000**. Model supporting up to 50 City Multi groups.
- **INMBSMIT100C000**. Model supporting up to 100 City Multi groups.

## 2 Modbus interface

### ***Functions supported***

This part is common for Modbus RTU and TCP.

Modbus functions 03 and 04 (*Read Holding Registers* and *Read Input Registers*) can be used to read Modbus registers.

Modbus functions 06 and 16 (*Single Multiple Holding Registers* and *Write Multiple Holding Registers*) can be used to write Modbus registers.

Configuration of poll records is possible between Modbus addresses 0 and 20000. Addresses that are not defined in section 2.4 (Modbus map of the device) are read-only and will always report 0.

Modbus error codes are supported, they will be sent whenever a non-valid Modbus address is queried.

All registers are 16-bit signed integer, in standard Modbus Big Endian (MSB/LSB) format.

Intesis supports Modbus RTU and Modbus TCP and both interfaces can be used simultaneously.

### ***Modbus RTU***

Both EIA485 and EIA232 physical layers are supported. Only the lines RX, TX and GND of the EIA232 connector are used (TX and RX for EIA485).

Baud rate can be selected between 1200, 2400, 4800, 9600, 19200, 38400, 56700 and 115200. Parity (none, even or odd) and stop bits (1 or 2) can be selected as well.

Modbus slave number must be configured and the physical connection (RS232 or RS485) can also be selected.

### ***Modbus TCP***

TCP port to use (default is 502) and keep alive period must be configured.

IP settings of Intesis (DHCP status, own IP, net mask and default gateway) must be configured as well.

### ***Modbus Address Map***

#### 2.1.1 Centralized Controller signals

There are 26 global signals for each centralized controller. Their Modbus addresses can be obtained applying the following formula:

$$\text{Modbus Address} = (\text{CC NUMBER} \times 30) + \text{SIGNAL NUMBER}$$

Where:

CC NUMBER: 0..1  
SIGNAL NUMBER: 0..9, see following table

Modbus address from the formula is expressed in link layer format. This is, first register address is 0.

Modbus Address First Address is 0	Read/ Write	Register/signal name	Possible values
(cc x 30) + 0 <i>cc stands for centralized controller number and is 0 or 1</i>	R	Centralized controller communication error	0-Ok, 1-Communication error
(cc x 30) + 1	W	Reset errors for all the groups	1-Reset the errors
(cc x 30) + 2	W	On (all the groups)	1-Set the groups On
(cc x 30) + 3	W	Off (all the groups)	1-Set the groups Off
(cc x 30) + 4	W	Operation Mode Auto (all the IC groups)	1-Set Auto Mode
(cc x 30) + 5	W	Operation Mode Heat (all the IC groups)	1-Set Heat Mode
(cc x 30) + 6	W	Operation Mode Dry (all the IC groups)	1-Set Dry Mode
(cc x 30) + 7	W	Operation Mode Fan (all the IC groups)	1-Set Fan Mode
(cc x 30) + 8	W	Operation Mode Cool (all the IC groups)	1-Set Cool Mode
(cc x 30) + 9	W	Operation Mode Setback (all the IC groups)	1-Set Setback Mode
(cc x 30) + 10	W	Operation Mode LC_Auto (all the LOSSNAY groups)	1-Set LC_Auto Mode
(cc x 30) + 11	W	Operation Mode Heat Recovery (all the LOSSNAY groups)	1-Set Heat Recovery Mode
(cc x 30) + 12	W	Operation Mode Bypass (all the LOSSNAY groups)	1-Set Bypass Mode
(cc x 30) + 13	W	Fan Speed (all the IC groups)	1-Set Fan Speed Auto
(cc x 30) + 14	W	Fan Speed (all the IC&LOSSNAY groups)	1-Set Fan Speed Low
(cc x 30) + 15	W	Fan Speed (all the IC groups)	1-1-Set Fan Speed Mid-1
(cc x 30) + 16	W	Fan Speed (all the IC groups)	1-1-Set Fan Speed Mid-2
(cc x 30) + 17	W	Fan Speed (all the IC&LOSSNAY groups)	1-Set Fan Speed High
(cc x 30) + 18	W	Vane position (all the IC groups)	1-Set Vanes Auto
(cc x 30) + 19	W	Vane position (all the IC groups)	1-Set Vanes Horizontal



(cc x 30) + 20	W	Vane position (all the IC groups)	1-Set Vanes Position-2
(cc x 30) + 21	W	Vane position (all the IC groups)	1-Set Vanes Position-3
(cc x 30) + 22	W	Vane position (all the IC groups)	1-Set Vanes Position-4
(cc x 30) + 23	W	Vane position (all the IC groups)	1-Set Vanes Vertical
(cc x 30) + 24	W	Vane position (all the IC groups)	1-Set Vanes Swing
(cc x 30) + 25	W	Individual Temperature Setpoint (°C) (all the groups)	5..90 °C

### 2.1.2 City Multi Group signals

The are up to 38 signals per every City Multi group. The number of actual addresses will depend on unit type, configuration and features of the centralized controller. Their Modbus addresses can be obtained applying the following formula:

$$\text{Modbus Address} = (( \text{CC NUMBER} \times 50 ) + \text{GROUP NUMBER} ) \times 100 + \text{SIGNAL NUMBER}$$

Where:

- CC NUMBER: 0..1
- GROUP NUMBER 1..50, according to configuration in Centralized Controller
- SIGNAL NUMBER: 0..37, see following table

Modbus address from the formula is expressed in link layer format. This is, first register address is 0.

Available signals depend on unit type, which must be selected in MAPS configuration tool:

- IC: Air conditioning indoor unit (VRF, M-series, P-series and K-control unit)
- LC: Lossnay
- FU: Outdoor-Air Processing unit
- BU: Air to Water Booster unit
- WH: Air to Water HEX unit
- CEh: Heat Pump

Modbus Address <small>First Address is 0</small>	Unit type						R/W	Register/signal name	Possible values
	IC <small>(AC/KE)</small>	LC	FU	BU	WH	CEh			
$((cc \times 50) + g) \times 100 + 0$ <small>cc stands for centralized controller number and is 0 or 1 g stands for group number and is 1 to 50</small>	x	x	x	x	x	x	R/W	On/Off	0-Off, 1-On
$((cc \times 50) + g) \times 100 + 1$	x		x				R/W	Operation Mode IC	0-Auto, 1-Heat, 2-Dry, 3-Fan, 4-Cool, 5-Auto Heat, 6-Auto Cool, 7-Setback, 8-Setbackheat, 9-Setbackcool
$((cc \times 50) + g) \times 100 + 1$		x					R/W	Operation Mode LOSSNAY	0-LC_Auto, 1-Heat Recovery, 2-Bypass

$((cc \times 50) + g) \times 100 + 1$				x	x	x	R/W	Operation Mode ATW & HWHP	0-Hot_Water, 1-Heating, 2-Heating_Eco, 3-Anti_Freeze, 4-Cooling
$((cc \times 50) + g) \times 100 + 2$	x		x				R/W	Fan Speed IC	0-Auto, 1-Low, 2-Mid-1, 3-Mid-2, 2-Mid2, 3-Mid1, 4-High
$((cc \times 50) + g) \times 100 + 2$		x					R/W	Fan Speed LOSSNAY	1-Low, 1-Mid2, 2-High
$((cc \times 50) + g) \times 100 + 3$	x						R/W	Vane position	0-Auto, 1-Horizontal, 2-Position-2, 3-Position-3, 4-Position-4, 5-Vertical, 6-Swing
$((cc \times 50) + g) \times 100 + 4$	x		x				R/W	Temperature Setpoint (°C)	Cool or dry:19..30 °C; Heat or Auto:17..28 °C
$((cc \times 50) + g) \times 100 + 4$	x			x	x	x	R/W	Temperature Setpoint (°C)	5..90 °C
$((cc \times 50) + g) \times 100 + 5$	x		x	x	x	x	R	Ambient Temperature (°C/x10°C)	0.0..99.9
$((cc \times 50) + g) \times 100 + 6$	x						R/W	Operational Status for Lossnay or OA	0-Off, 1-Low, 2-High
$((cc \times 50) + g) \times 100 + 7$	x	x	x	x	x	x	R	Group operation time (x100 hours)	0..9999
$((cc \times 50) + g) \times 100 + 8$	x	x	x	x	x	x	R	Group operation time (%100 hours)	0..99
$((cc \times 50) + g) \times 100 + 9$	x	x	x	x	x	x	R	Group error status	0-No error; 1-Group error
$((cc \times 50) + g) \times 100 + 10$	x	x	x	x	x	x	R	Group error code	Number of the error code (XXXX)
$((cc \times 50) + g) \times 100 + 11$	x	x	x	x	x	x	W	Group error reset	1-Reset the error
$((cc \times 50) + g) \times 100 + 12$	x	x	x	x	x	x	R	Group model	Model of units connected to group
$((cc \times 50) + g) \times 100 + 13$	x	x	x	x	x	x	R/W	Allow ON/OFF control from the local panel	0-Allow, 1-Not allow
$((cc \times 50) + g) \times 100 + 14$	x	x	x	x	x	x	R/W	Allow operation mode control from the local panel	0-Allow, 1-Not allow
$((cc \times 50) + g) \times 100 + 15$	x		x	x	x	x	R/W	Allow set point control from the local panel	0-Allow, 1-Not allow
$((cc \times 50) + g) \times 100 + 16$	x	x	x				R/W	Allow filter reset control from the local panel	0-Allow, 1-Not allow
$((cc \times 50) + g) \times 100 + 17$	x						R/W	Allow air direction control from the local panel <i>Only available when configuration parameter 'Old Model Compatibility' is set to 'New model'</i>	0-Allow, 1-Not allow
$((cc \times 50) + g) \times 100 + 18$	x	x	x				R/W	Allow fan speed control from the local panel <i>Only available when configuration parameter 'Old Model Compatibility' is set to 'New model'</i>	0-Allow, 1-Not allow
$((cc \times 50) + g) \times 100 + 19$	x		x				R/W	Allow timer control from the local panel <i>Only available when configuration parameter 'Old Model Compatibility' is set to 'New model'</i>	0-Allow, 1-Not allow
$((cc \times 50) + g) \times 100 + 20$	x		x				R/W	Setback control <i>Only available when configuration parameter 'Centralized Controller Model' is set to 'EB50-GU' or 'AE-200 or newer'</i>	0-Disable, 1-Enable

$((cc \times 50) + g) \times 100 + 21$	x		x				R/W	Minimum cool setpoint restriction	4.5..35°C
$((cc \times 50) + g) \times 100 + 22$	x		x				R/W	Maximum cool setpoint restriction	4.5..35°C
$((cc \times 50) + g) \times 100 + 23$	x		x				R/W	Minimum heat setpoint restriction	4.5..35°C
$((cc \times 50) + g) \times 100 + 24$	x		x				R/W	Maximum heat setpoint restriction	4.5..35°C
$((cc \times 50) + g) \times 100 + 25$	x		x				R/W	Minimum auto setpoint restriction	4.5..35°C
$((cc \times 50) + g) \times 100 + 26$	x		x				R/W	Maximum auto setpoint restriction	4.5..35°C
$((cc \times 50) + g) \times 100 + 27$	x		x				R/W	Cool/dry/auto(upper) dual temperature setpoint (°C) <i>Only available when configuration parameter 'Setpoint Type' is set to 'Multiple Setpoint'</i>	4.5..90°C
$((cc \times 50) + g) \times 100 + 27$				x	x	x	R/W	Heating ATW & HWHP temperature setpoint (°C) <i>Only available when configuration parameter 'Setpoint Type' is set to 'Multiple Setpoint'</i>	4.5..90°C
$((cc \times 50) + g) \times 100 + 28$	x		x				R/W	Heat/auto(lower) dual temperature setpoint (°C) <i>Only available when configuration parameter 'Setpoint Type' is set to 'Multiple Setpoint'</i>	4.5..90°C
$((cc \times 50) + g) \times 100 + 28$				x	x	x	R/W	Heating ECO ATW temperature setpoint (°C) <i>Only available when configuration parameter 'Setpoint Type' is set to 'Multiple Setpoint'</i>	4.5..90°C
$((cc \times 50) + g) \times 100 + 29$	x		x				R/W	Auto single temperature setpoint (°C) <i>Only available when configuration parameter 'Setpoint Type' is set to 'Multiple Setpoint'</i>	4.5..90°C
$((cc \times 50) + g) \times 100 + 29$				x	x	x	R/W	Hot water ATW & HWHP temperature setpoint (°C) <i>Only available when configuration parameter 'Setpoint Type' is set to 'Multiple Setpoint'</i>	4.5..90°C
$((cc \times 50) + g) \times 100 + 30$	x		x				R/W	Setback upper temperature setpoint (°C) <i>Only available when configuration parameter 'Setpoint Type' is set to 'Multiple Setpoint'</i>	4.5..90°C
$((cc \times 50) + g) \times 100 + 30$				x	x	x	R/W	Anti-Freeze ATW temperature setpoint (°C) <i>Only available when configuration parameter 'Setpoint Type' is set to 'Multiple Setpoint'</i>	4.5..90°C
$((cc \times 50) + g) \times 100 + 31$	x		x				R/W	Setback lower temperature setpoint (°C) <i>Only available when configuration parameter 'Setpoint Type' is set to 'Multiple Setpoint'</i>	4.5..90°C
$((cc \times 50) + g) \times 100 + 31$				x	x	x	R/W	Cooling ATW temperature setpoint (°C) <i>Only available when configuration parameter 'Setpoint Type' is set to 'Multiple Setpoint'</i>	4.5..90°C
$((cc \times 50) + g) \times 100 + 32$	x		x				R	Room Humidity <i>Only available when configuration parameter 'URC Controller' is set to 'Available'</i>	0..100%
$((cc \times 50) + g) \times 100 + 33$	x		x				R	Brightness status <i>Only available when configuration parameter 'Setpoint Type' is set to 'Multiple Setpoint'</i>	0: Dark, 1: Bright
$((cc \times 50) + g) \times 100 + 34$	x		x				R	Occupancy <i>Only available when configuration parameter 'Setpoint Type' is set to 'Multiple Setpoint'</i>	0: Absence, 1:Occupancy
$((cc \times 50) + g) \times 100 + 35$						x	R	Outdoor temperature <i>Only available when configuration parameter 'Centralized Controller Model' is set to 'AE-200 or newer'.</i>	0.0..99.9
$((cc \times 50) + g) \times 100 + 36$	x	x	x				R	Filter status	0-Ok, 1-Dirty

$((cc \times 50) + g) \times 100 + 37$	x	x	x					w	Dirty filter indication reset	1: Reset the filter
--	---	---	---	--	--	--	--	---	-------------------------------	---------------------

### 3 Connections

Find below information regarding the Intesis connections available.

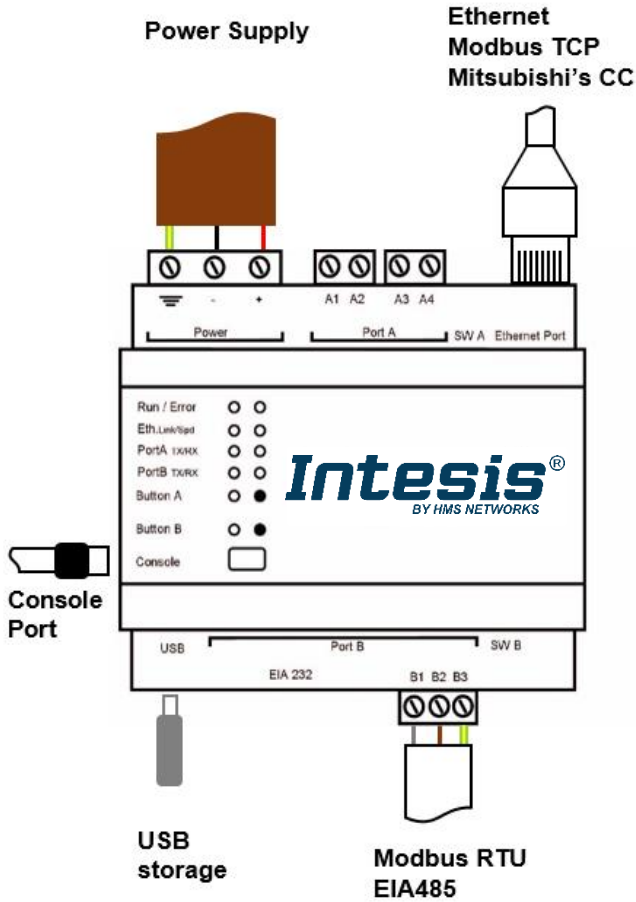

**Power Supply**

Must use NEC Class 2 or Limited Power Source (LPS) and SELV rated power supply.

**If using DC power supply:**

Respect polarity applied of terminals (+) and (-). Be sure the voltage applied is within the range admitted (check table below). The power supply can be connected to earth but only through the negative terminal, never through the positive terminal.

**If using AC power supply:**

Make sure the voltage applied is the value admitted (24 Vac). Do not connect any of the terminals of the AC power supply to earth, and make sure the same power supply is not supplying any other device.

**Ethernet / Modbus TCP / Mitsubishi C. Controller**

Connect the cable coming from the IP network to the connector ETH of the gateway. Use an Ethernet CAT5 cable. If communicating through the LAN of the building, contact the network administrator and make sure traffic on the port used is allowed through all the LAN path (check the gateway user manual for more information). Default IP is 192.168.100.246. DHCP is enabled by default.

Figure 3.1 Gateway's connections

**PortA**

Not used

**PortB / Modbus RTU**

Connect the EIA485 bus to connectors B1 (+), B2 (-) and B3 (SNGD) of gateway's PortB. Respect the polarity.

Remember the characteristics of the standard EIA485 bus: maximum distance of 1200 meters, maximum 32 devices connected to the bus, and in each end of the bus it must be a termination resistor of 120 Ω. The gateway has an internal bus biasing circuit that incorporates the termination resistor. If you install the gateway in one of the ends of the bus, then do not install an additional termination resistor in that end.

**Console Port**

Connect a mini-type B USB cable from your computer to the gateway to allow communication between the Configuration Software and the gateway. Remember that Ethernet connection is also allowed. Check the user manual for more information.

**USB**

Connect a USB storage device (not a HDD) if required. Check the user manual for more information.

Ensure proper space for all connectors when mounted (see section 66).

## **Power device**

The first step to perform is to power up the device. To do so, a power supply working with any of the voltage range allowed is needed (check section 5). Once connected the ON led will turn on.

## **Connect to Mitsubishi's Centralized Controller(s).**

Connect the communication cable coming from the network hub, switch or direct from the Centralized Controller to the Ethernet port (Figure 3.1) of the gateway. The cable to be used shall be a straight Ethernet UTP/FTP CAT5 cable.

In case there is no response from Mitsubishi Centralized Controller to the frames sent by the gateway, check that it is operative and reachable from the network connection used by the gateway. Check the gateway's Ethernet interface sending Pings to its IP address using a PC connected to the same Ethernet IP network. If the problem persists communicating through the LAN of the building, contact the network administrator and make sure traffic on the port used is allowed through all the LAN path.

*Intesis Modbus Server – Mitsubishi Centralized Controller* comes with DHCP functionality enabled by default.

## **Connection to Modbus**

### **3.1.1 Modbus TCP**

Same ethernet connection as for Mitsubishi's Centralized Controller is used. Connect the communication cable coming from the network hub or switch to the Ethernet port of Intesis. The cable to be used shall be a straight Ethernet UTP/FTP CAT5 cable.

### **3.1.2 Modbus RTU**

Connect the communication cable coming from the Modbus network to the port marked as Port B of Intesis. Connect the EIA485 bus to connectors B1 (-), B2 (+) and B3 (SNGD) of gateway's PortB. Respect the polarity.

Remember the characteristics of the standard EIA485 bus: maximum distance of 1200 meters, maximum 32 devices (without repeaters) connected to the bus, and in each end of the bus it must be a termination resistor of 120  $\Omega$ . The gateway has an internal bus biasing circuit that incorporates the termination resistor. Bus biasing and termination resistor for EIA485 can be enabled for PortB by means of a dedicated DIP switch.

## **Connect to PC (Configuration tool)**

This action allows the user to have access to configuration and monitoring of the device. Two methods to connect to the PC can be used:

- **Ethernet:** Using the Ethernet port of the Intesis.
- **USB cable:** To connect the device to the PC, the USB cable supplied should be plugged to the USB Console port.

## 4 Set-up process and troubleshooting

### Pre-requisites

It is necessary to have the Modbus RTU or TCP master/client device (BMS side device) operative and properly connected to the corresponding port of the gateway. It is also required to have a Mitsubishi Centralized Controller with Ethernet connected to the gateway.

Connectors, connection cables, PC for the Configuration Tool usage and other auxiliary material, if needed, are not supplied by Intesis for this standard integration.

Items supplied with this product for this integration are:

- Intesis gateway.
- Link to download the configuration tool.
- USB Console cable to communicate with Intesis.
- Product documentation.

### Intesis MAPS. Configuration & monitoring tool for Intesis

#### 4.1.1 Introduction

Intesis MAPS is a Windows® compatible software developed specifically to monitor and configure Intesis new generation gateways.

The installation procedure and main functions are explained in the *Intesis MAPS User Manual*. This document can be downloaded from the link indicated in the installation sheet supplied with the Intesis device or in the product website at [www.intesis.com](http://www.intesis.com)

In this section, only the specific case of Mitsubishi Electric's Centralized Controller to Modbus will be covered.

Please check the Intesis MAPS user manual for specific information about the different parameters and how to configure them.

#### 4.1.2 Connection

To configure the Intesis connection parameters press on the **Connection** button in the *menu bar*.

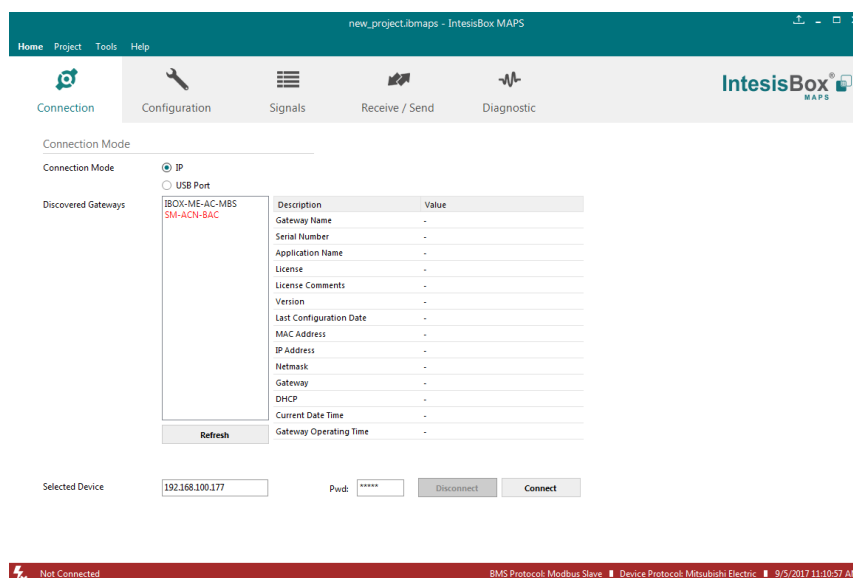

Figure 4.1 MAPS connection

### 4.1.3 Configuration tab

Select the **Configuration** tab to configure the connection parameters. Three subsets of information are shown in this window: General (Gateway general parameters), Modbus Slave (Modbus interface configuration) and Mitsubishi Electric (Centralized Controller/s interface parameters).

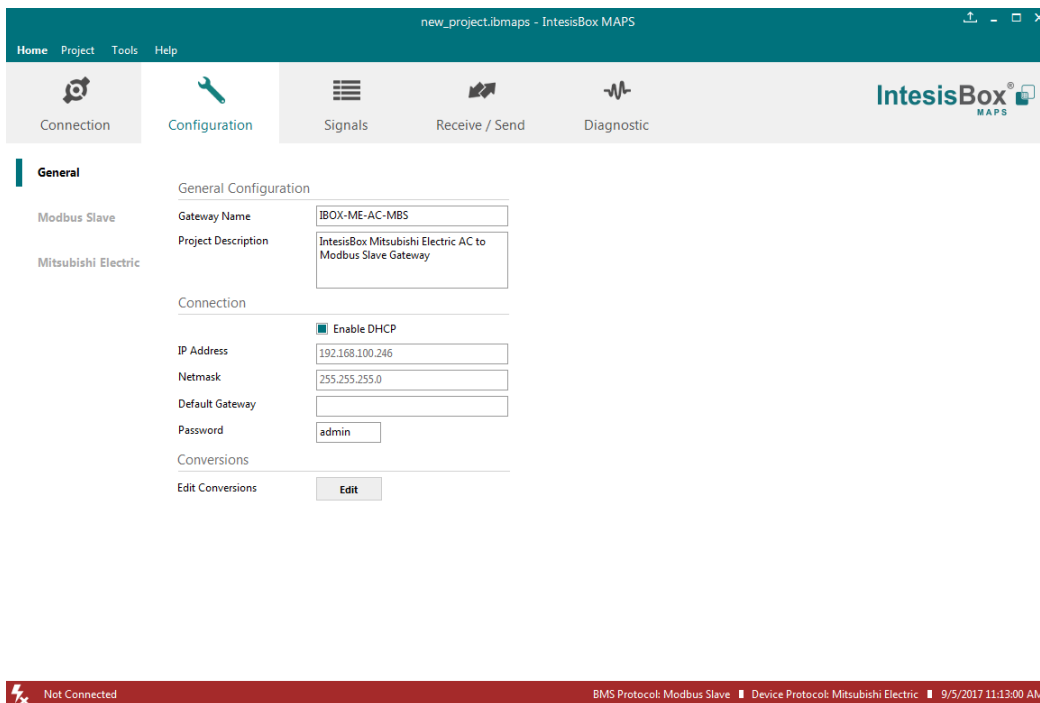

Figure 4.2 Intesis MAPS configuration tab

General and Modbus Slave tabs are explained in Intesis MAPS user manual for Intesis Modbus Server Series. We are including in this manual the specific Modbus Slave settings which applies to this gateway configuration exclusively.

Modbus Slave settings for Mitsubishi Electric CC gateway:

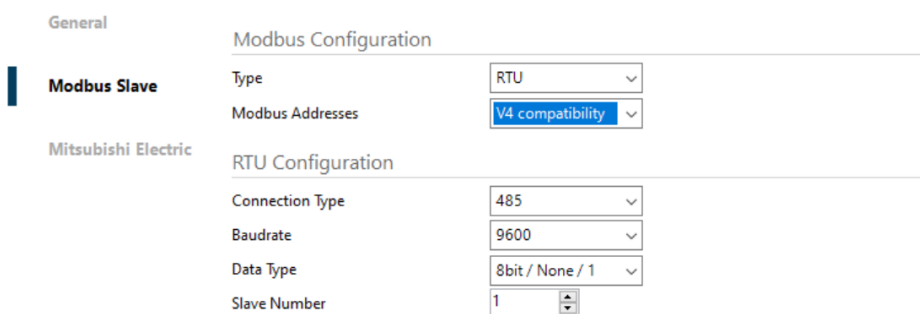

Figure 4.3 Intesis MAPS Modbus slave settings

When selecting **Modbus addresses** → **V4 compatibility**, Modbus registers are adapted to the previous V4 version of the gateway.

The purpose of this setting is to be used when the gateway is replacing a previous V4 gateway.

#### 4.1.3.1 Mitsubishi Electric Configuration

Set the parameters for connection with Mitsubishi Electric's Centralized Controller.



The screenshot shows the 'Intesis MAPS configuration tab' with the following details:

- General** tab is selected.
- Modbus Slave** is set to **Mitsubishi Electric**.
- Controllers Configuration** section:
  - Centralized controller 1** is expanded, showing a list of groups G1 through G10. G1 is checked.
  - IP**: 192.168.1.1
  - Description**: (empty text field)
  - Controller Type**: Controller Direct Connection
  - Centralized Controller Model**: AE-200, EW-50 or newer
  - Old Model Compatibility**: New Model
  - Add indoor/outdoor individual error signals**:
  - Scan Groups**:
- Advanced Parameters** section:
  - Polling Period**: 200
  - Answer Timeout**: 10
  - Controller Connection Timeout**: 5

**Figure 4.4** Intesis MAPS configuration tab

Up to two Centralized Controller's can be configured (depending on the Intesis version). Each Centralized controller must be configured with the following parameters:

1. **IP:** IP Address of the Centralized Controller.
2. **Description:** Text description for the Centralized Controller
3. **Controller type:** Select if Centralized Controller has direct connection, or it is an Expansion Controller. Possible values are:
  - Controller Direct Connection
  - Expansion Controller 1
  - Expansion Controller 2
  - Expansion Controller 3
4. **Centralized Controller Model:** Select the Centralized Controlled model. Possible values are:
  - AG-150A, GB-50ADA or older
  - EB-50GU
  - AE-200, EW-50 or newer
5. **Old Model Compatibility:** Set up if EB-50GU or AE-200 (or newer) Centralized Controller has been setup in 'Old Compatibility' mode.
6. **Add indoor/outdoor individual error signals.** This checkbox activates individual error signals for the indoor and outdoor AC units. Find these registers between 20001 to 20100 for the Centralized Controller 1 and 21001 to 21100 for the Centralized Controller 2.

For each Centralized Controller, it must also be selected the groups that will be monitored/controlled using Intesis. You can do it manually in 'Controllers Configuration' section, by unfolding the corresponding 'Centralized Controller' in the list of controllers.

You can also scan for available groups under the IP of the Centralized Controller:

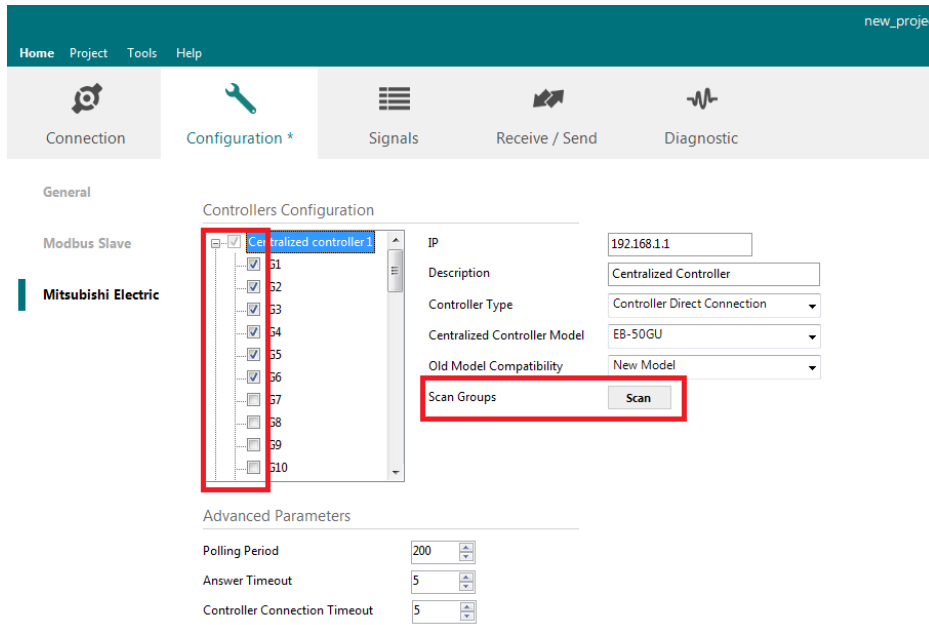

Figure 4.5 Selection of active groups in Centralized Controller

By pressing the 'Scan' button, 'Discover Controller Groups' window will appear:

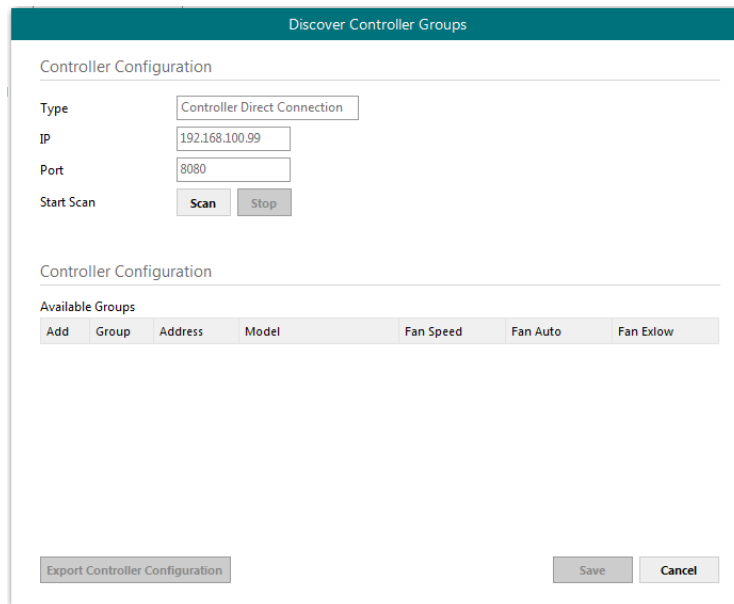

Figure 4.6 Discover control groups window

By pressing 'Scan' button, configured Centralized Controller will be scanned for available control groups. Error window will appear if there is a problem in the connection with the Centralized Controller (Ethernet cable not connected, wrong IP address for Centralized Controller, PC Monitoring license in Centralized Controller is not active, ...).

A progress bar will appear during the scan, which will take a few seconds (up to 1 or 2 minutes). After scan is completed, detected groups will be shown in the 'Available Groups' area, as follows:

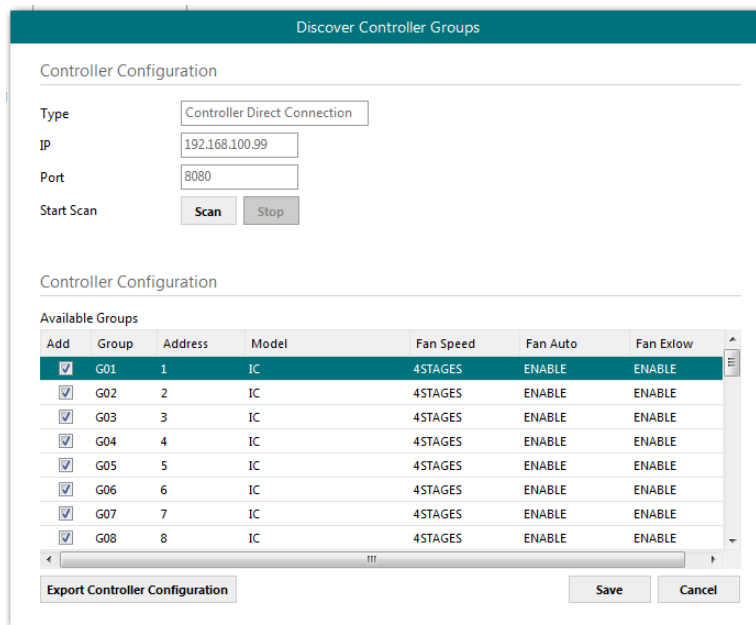

Figure 4.7 Scan results window

From available groups, mark the checkbox under column 'Add' to select these groups as active and configured in the Centralized Controller.

By pressing the 'Save' button, information will be passed to previous 'Controllers Configuration' window in MAPS.

'Discover Control Groups' also allows to Export Controller Configuration (see corresponding button in Figure 4.), which will generate a text file with the active groups in the controller, for documentation and support purposes.

Once the list of active groups is filled, parameters for each group must be configured. For doing so, select each group in the list:

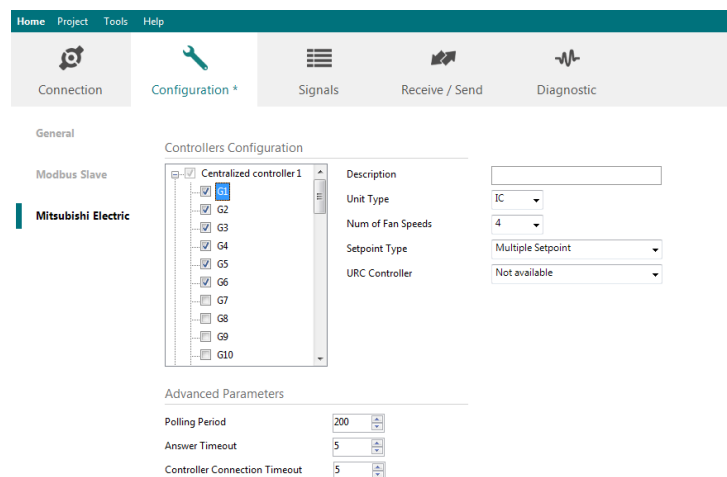

Figure 4.8 Scan results window

Parameters that must be configured for each group are the following:

- Description:** Text description for the control Group
- Unit Type:** Possible values are:

Number	Model	Description	Availability: SCAN only or both (manual selection + SCAN)
0	IC	Air conditioning indoor unit (VRF, M-series, P-series and K-control unit)	Both
1	KIC	Indoor unit (K-control unit)	SCAN only
2	AIC	Indoor unit (P-Series)	SCAN only
3	LC	Lossnay	Both
4	FU	Outdoor-Air Processing unit	Both
5	BU	Air to Water Booster unit	Both
6	WH	Air to Water HEX unit	Both
7	CEh	Heat Pump	Both
8	DC	DiDo controller	SCAN only
9	AHC	ALL HVAC CONTROOLER	SCAN only
10	RC	ME remote controller (old type) / Simple Remote Controller(old type)	SCAN only
11	ME	ME remote controller (new type)	SCAN only
12	CR	Simple Remote Controller (new type)	SCAN only
13	URC	New Remote Controller	SCAN only
14	EGW	EB-50	SCAN only
15	TR	AG-150,GB-50,G-5	SCAN only
16	AN	OnOff remote controller	SCAN only
17	GR	Group remote controller	SCAN only
18	SR	System remote controller	SCAN only
19	ST	Schedule remote controller	SCAN only
20	SC	other controller	SCAN only
21	-		SCAN only
22	NONE		SCAN only

3. **Setpoint type:** Select if unit supports different setpoints according to operation mode, or it supports single setpoint.

4. **URC Controller:** Select if unit has URC controller

Please note that the scan is taking the configuration of “Unit Type”, “Num of Fan Speeds” and “URC Controller” automatically so you might not need to modify these parameters after performing a scan.

Finally, in addition to Centralized Controller parameters, and parameters for each corresponding group, there is a set of advanced global parameters defining the communication of the Intesis with the centralized controller. These are following:

**Figure 4.9** Advanced Parameters for communication with Centralized Controllers

For them, the default values should be correct for most installations. They might need adjusting in particular cases where there are particular requirements in the communication. Their function is following:

1. **Polling Period:** Time in milliseconds between each request sent to the Centralized Controller
2. **Answer Timeout:** Time in seconds that Intesis will wait for a response from Centralized Controller after sending a single request for information through TCP/IP.
3. **Controller Connection Timeout:** After Intesis starts TCP/IP socket connection, time that the Intesis will wait for the Centralized Controller to accept the socket request. For each individual request, Intesis starts a new socket connection.

### 4.1.4 Signals

All available registers, its corresponding description and other main parameters are listed in the signals tab.

#	Active	Description	Modbus Slave			Mitsubishi Electric		
			# Bits	Format	Address	Read / Write	Group	Controller
1	<input checked="" type="checkbox"/>	Centralized controller communication error [0-Ok, 1-Communication error]	16	0: Unsigned	0	0: Read	-	Controller 1
2	<input checked="" type="checkbox"/>	Reset errors for all the groups [1-Reset the errors]	16	0: Unsigned	1	1: Trigger	-	Controller 1
3	<input checked="" type="checkbox"/>	On (all the groups) [1-Set the groups On]	16	0: Unsigned	2	1: Trigger	-	Controller 1
4	<input checked="" type="checkbox"/>	Off (all the groups) [1-Set the groups Off]	16	0: Unsigned	3	1: Trigger	-	Controller 1
5	<input checked="" type="checkbox"/>	Operation Mode Auto (all the IC groups) [1-Set Auto Mode]	16	0: Unsigned	4	1: Trigger	-	Controller 1
6	<input checked="" type="checkbox"/>	Operation Mode Heat (all the IC groups) [1-Set Heat Mode]	16	0: Unsigned	5	1: Trigger	-	Controller 1
7	<input checked="" type="checkbox"/>	Operation Mode Dry (all the IC groups) [1-Set Dry Mode]	16	0: Unsigned	6	1: Trigger	-	Controller 1
8	<input checked="" type="checkbox"/>	Operation Mode Fan (all the IC groups) [1-Set Fan Mode]	16	0: Unsigned	7	1: Trigger	-	Controller 1
9	<input checked="" type="checkbox"/>	Operation Mode Cool (all the IC groups) [1-Set Cool Mode]	16	0: Unsigned	8	1: Trigger	-	Controller 1
10	<input checked="" type="checkbox"/>	Operation Mode Setback (all the IC groups) [1-Set Setback Mode]	16	0: Unsigned	9	1: Trigger	-	Controller 1
11	<input checked="" type="checkbox"/>	Operation Mode LC_Auto (all the LOSSNAY groups) [1-Set LC_Auto Mode]	16	0: Unsigned	10	1: Trigger	-	Controller 1
12	<input checked="" type="checkbox"/>	Operation Mode Heat Recovery (all the LOSSNAY groups) [1-Set Heat Recovery Mode]	16	0: Unsigned	11	1: Trigger	-	Controller 1
13	<input checked="" type="checkbox"/>	Operation Mode Bypass (all the LOSSNAY groups) [1-Set Bypass Mode]	16	0: Unsigned	12	1: Trigger	-	Controller 1
14	<input checked="" type="checkbox"/>	Fan Speed (all the IC groups) [1-Set Fan Speed Auto]	16	0: Unsigned	13	1: Trigger	-	Controller 1
15	<input checked="" type="checkbox"/>	Fan Speed (all the IC&LOSSNAY groups) [1-Set Fan Speed Low]	16	0: Unsigned	14	1: Trigger	-	Controller 1
16	<input checked="" type="checkbox"/>	Fan Speed (all the IC groups) [1-1-Set Fan Speed Mid-1]	16	0: Unsigned	15	1: Trigger	-	Controller 1
17	<input checked="" type="checkbox"/>	Fan Speed (all the IC groups) [1-1-Set Fan Speed Mid-2]	16	0: Unsigned	16	1: Trigger	-	Controller 1
18	<input checked="" type="checkbox"/>	Fan Speed (all the IC&LOSSNAY groups) [1-1-Set Fan Speed High]	16	0: Unsigned	17	1: Trigger	-	Controller 1
19	<input checked="" type="checkbox"/>	Vane position (all the IC groups) [1-Set Vanes Auto]	16	0: Unsigned	18	1: Trigger	-	Controller 1
20	<input checked="" type="checkbox"/>	Vane position (all the IC groups) [1-Set Vanes Horizontal]	16	0: Unsigned	19	1: Trigger	-	Controller 1
21	<input checked="" type="checkbox"/>	Vane position (all the IC groups) [1-Set Vanes Position-2]	16	0: Unsigned	20	1: Trigger	-	Controller 1
22	<input checked="" type="checkbox"/>	Vane position (all the IC groups) [1-Set Vanes Position-3]	16	0: Unsigned	21	1: Trigger	-	Controller 1
23	<input checked="" type="checkbox"/>	Vane position (all the IC groups) [1-Set Vanes Position-4]	16	0: Unsigned	22	1: Trigger	-	Controller 1
24	<input checked="" type="checkbox"/>	Vane position (all the IC groups) [1-Set Vanes Vertical]	16	0: Unsigned	23	1: Trigger	-	Controller 1
25	<input checked="" type="checkbox"/>	Vane position (all the IC groups) [1-Set Vanes Swing]	16	0: Unsigned	24	1: Trigger	-	Controller 1
26	<input checked="" type="checkbox"/>	Individual Temperature Setpoint(°C)(all the groups) [5..90 °C]	16	0: Unsigned	25	1: Trigger	-	Controller 1
27	<input checked="" type="checkbox"/>	On / Off[0 - Off; 1 - On]	16	0: Unsigned	100	2: Read / Write	G1	Controller 1
28	<input checked="" type="checkbox"/>	Operation Mode IC [0-Auto; 1-Heat; 2-Dry; 3-Fan; 4-Cool; 5-AutoHeat; 6-AutoCool; 7-Setback; 8-Sb-heat; 9-Sb-co...	16	0: Unsigned	101	2: Read / Write	G1	Controller 1
29	<input checked="" type="checkbox"/>	Fan Speed IC [0-Auto; 1-Low; 2-Mid2; 3-Mid1; 4-High]	16	0: Unsigned	102	2: Read / Write	G1	Controller 1
30	<input checked="" type="checkbox"/>	Vane Position [0-Auto; 1-Horizontal; 2-Position-2; 3-Position-3; 4-Position-4; 5-Vertical; 6-Swing]	16	0: Unsigned	103	2: Read / Write	G1	Controller 1
31	<input checked="" type="checkbox"/>	Temperature Setpoint (x10°C) [Cool or dry: 19°C to 30°C; Heat or Auto: 17°C to 28°C]	16	1: Signed (C2)	104	2: Read / Write	G1	Controller 1
32	<input checked="" type="checkbox"/>	Ambient Temperature (x10°C) [0.0°C to 99.9°C]	16	1: Signed (C2)	105	0: Read	G1	Controller 1
33	<input checked="" type="checkbox"/>	Operational Status of Lossnay or OA [0-Off; 1-Low; 2-High]	16	0: Unsigned	106	2: Read / Write	G1	Controller 1
34	<input checked="" type="checkbox"/>	Group Operation Time (x100 hours) [0 to 9999]	16	0: Unsigned	107	0: Read	G1	Controller 1
35	<input checked="" type="checkbox"/>	Group Operation Time (/100 hours) [0 to 99]	16	0: Unsigned	108	0: Read	G1	Controller 1
36	<input checked="" type="checkbox"/>	Group error status [0-No Error; 1-Group Error]	16	0: Unsigned	109	0: Read	G1	Controller 1
37	<input checked="" type="checkbox"/>	Group Error Code [XXXX-Error Code Number]	16	1: Signed (C2)	110	0: Read	G1	Controller 1
38	<input checked="" type="checkbox"/>	Group Error Reset [1-Reset the Error]	16	0: Unsigned	111	1: Trigger	G1	Controller 1
39	<input checked="" type="checkbox"/>	Group Model [0-IC; 1-KIC; 2-AIC; 3-LC; 4-FU; 5-BU; 6-WH; 7-CEh; 8-DC; 9-AHC ....]	16	0: Unsigned	112	0: Read	G1	Controller 1
40	<input checked="" type="checkbox"/>	Allow On/Off Control from the Local Panel [0-Allow; 1-Not Allow]	16	0: Unsigned	113	2: Read / Write	G1	Controller 1

Figure 4.10 Intesis MAPS Signals tab

### 4.1.5 Sending the configuration to Intesis

When the configuration is finished, follow the steps to program the gateway.

- 1.- Click on **Save** button to save the project to the project folder on your hard disk (more information in Intesis MAPS User Manual).
- 2.- You will be prompted to generate the configuration file to be sent to the gateway.
  - a.- If **Yes** is selected, the file containing the configuration for the gateway will be generated and saved also into the project folder.
  - b.- If **NO** is selected, remember that the binary file with the project needs to be generated before the Intesis starts to work as expected.
- 3.- Press the **Send File** button to send the binary file to the Intesis device. The process of file transmission can be monitored in the Intesis Communication Console window. Intesis will reboot automatically once the new configuration is loaded.

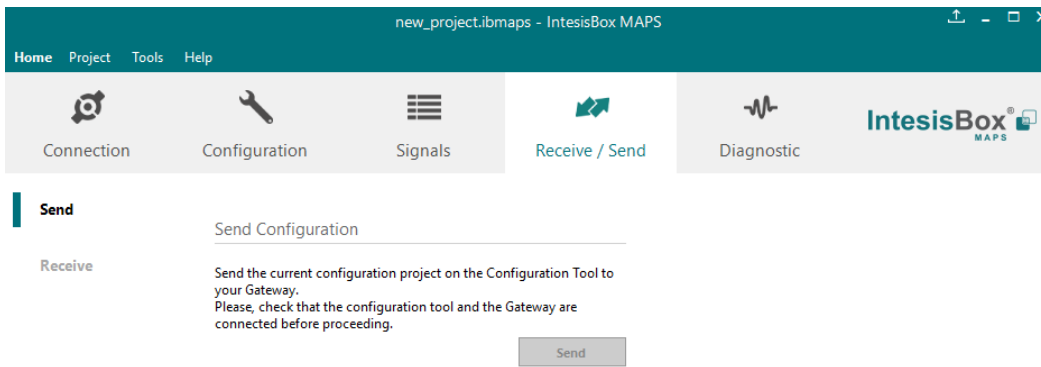

Figure 4.11 Intesis MAPS Receive/Send tab

After any configuration change, do not forget to send the configuration file to the Intesis using the button “Send”.

#### 4.1.6 Diagnostic

To help integrators in the commissioning tasks and troubleshooting, the Configuration Tool offers some specific tools and viewers.

In order to start using the diagnostic tools, the connection with the Gateway must be established.

The Diagnostic section is composed by two main parts: Tools and Viewers.

- **Tools**

Use the tools section to check the current hardware status of the box, log communications into compressed files to be sent to the support, change the Diagnostic panels’ view or send commands to the gateway.

- **Viewers**

In order to check the current status, viewer for the Internal and External protocols are available. It is also available a generic Console viewer for general information about communications and the gateway status. Finally a Signals Viewer to simulate the BMS behavior or to check the current values in the system.

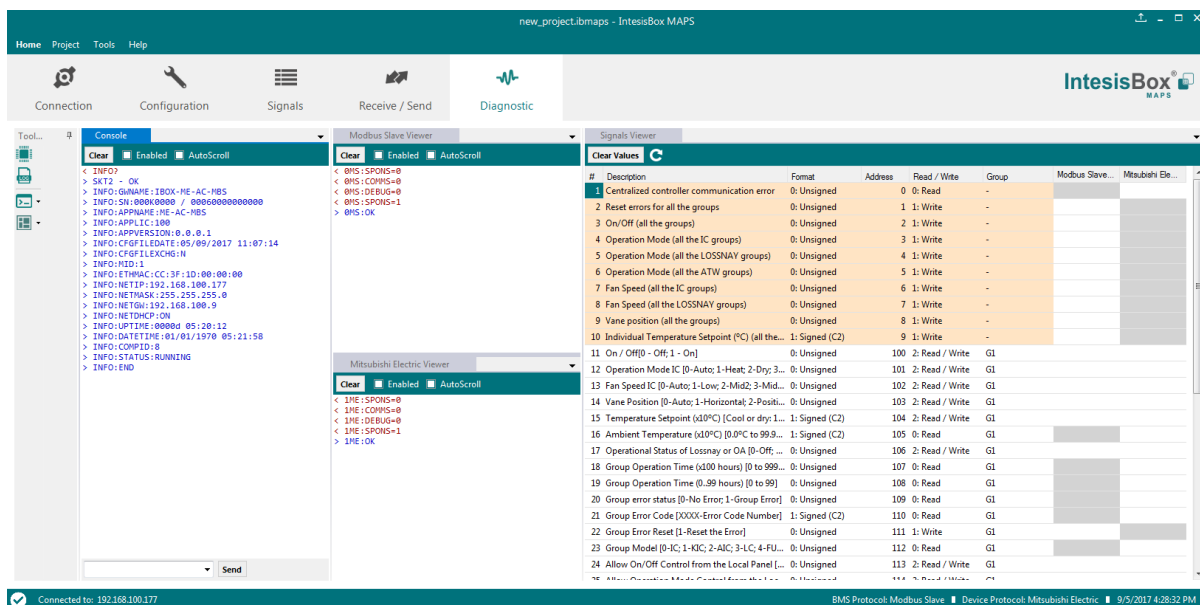

Figure 4.3 Diagnostic

More information about the Diagnostic section can be found in Intesis MAPS user manual for Intesis Modbus Server Series.

### Set-up procedure

1. Install Intesis MAPS on your laptop, use the setup program supplied for this and follow the instructions given by the Installation wizard.
2. Install Intesis in the desired installation site. Installation can be on DIN rail or on a stable not vibrating surface (DIN rail mounted inside a metallic industrial cabinet connected to ground is recommended).
3. If using Modbus RTU, connect the communication cable coming from the EIA485 port of the Modbus RTU installation to the port marked as Port B of Intesis (More details in section 3).

If using, Modbus TCP, connect the communication cable coming from the Ethernet port of the Modbus TCP installation to the port marked as Ethernet Port of Intesis (More details in section 3).

4. Connect the communication cable coming from Mitsubishi Electric's Centralized Controller network to the port marked as Ethernet Port of Intesis (More details in section 3).
5. Power up Intesis. The supply voltage can be 9 to 30 Vdc or just 24 Vac. Take care of the polarity of the supply voltage applied.

**WARNING!** In order to avoid earth loops that can damage Intesis and/or any other equipment connected to it, we strongly recommend:

- The use of DC power supplies, floating or with the negative terminal connected to earth. **Never use a DC power supply with the positive terminal connected to earth.**
- The use of AC power supplies only if they are floating and not powering any other device.

6. If you want to connect using IP, connect the Ethernet cable from the laptop PC to the port marked as Ethernet of Intesis (More details in section 3).

If you want to connect using USB, connect the USB cable from the laptop PC to the port marked as Console of Intesis (More details in section 3).

7. Open Intesis MAPS, create a new project for Modbus and select the IMBSMIT---C000-Template project.
8. Modify the configuration as desired, save it and download the configuration file to Intesis as explained in section 4.1.5 .
9. Visit the Diagnostic section, enable COMMS () and check that there is communication activity, some TX frames and some other RX frames. This means that the communication with the Centralized Controller and Modbus Master devices is OK. In case there is no communication activity between Intesis and the Centralized Controller and/or Modbus devices, check that those are operative: check the baud rate, the communication cable used to connect all devices and any other communication parameter.

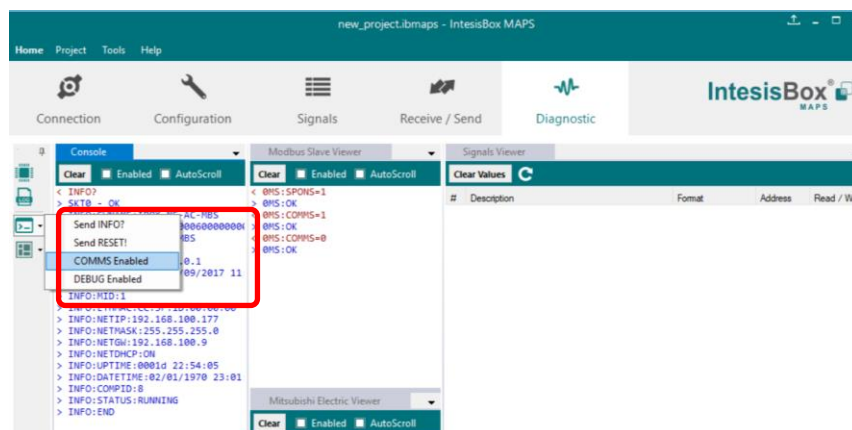

Figure 4.4 Enable COMMS



## 5 Electrical & Mechanical Features



<b>Enclosure</b>	Plastic, type PC (UL 94 V-0) Net dimensions (dxwxh): 90x88x56 mm Recommended space for installation (dxwxh): 130x100x100mm Color: Light Grey. RAL 7035	<b>Battery</b>	Size: Coin 20mm x 3.2mm Capacity: 3V / 225mAh Type: Manganese Dioxide Lithium
<b>Mounting</b>	Wall. DIN rail EN60715 TH35.	<b>Console Port</b>	Mini Type-B USB 2.0 compliant 1500VDC isolation
<b>Terminal Wiring</b> (for power supply and low-voltage signals)	Per terminal: solid wires or stranded wires (twisted or with ferrule) 1 core: 0.5mm <sup>2</sup> ... 2.5mm <sup>2</sup> 2 cores: 0.5mm <sup>2</sup> ... 1.5mm <sup>2</sup> 3 cores: not permitted	<b>USB port</b>	Type-A USB 2.0 compliant Only for USB flash storage device (USB pen drive) Power consumption limited to 150mA (HDD connection not allowed)
<b>Power</b>	1 x Plug-in screw terminal block (3 poles) 9 to 36VDC +/-10%, Max.: 140mA. 24VAC +/-10% 50-60Hz, Max.: 127mA Recommended: 24VDC	<b>Push Button</b>	Button A: Check the user manual Button B: Check the user manual
<b>Ethernet</b>	1 x Ethernet 10/100 Mbps RJ45 2 x Ethernet LED: port link and activity	<b>Operation Temperature</b>	0°C to +60°C
<b>Port A</b>	1 x Plug-in screw terminal block (2 poles) Reserved for future use 1 x Plug-in screw terminal block green (2 poles) Reserved for future use 1500VDC isolation from other ports	<b>Operational Humidity</b>	5 to 95%, no condensation
<b>Switch A</b> (SWA)	1 x DIP-Switch for serial EIA485 configuration: Reserved for future use	<b>Protection</b>	IP20 (IEC60529)
<b>PORT B</b>	1 x Serial EIA232 (SUB-D9 male connector) Pinout from a DTE device 1500VDC isolation from other ports (except PORT B: EIA485) 1 x Serial EIA485 Plug-in screw terminal block (3 poles) A, B, SGND (Reference ground or shield) 1500VDC isolation from other ports (except PORT B: EIA232)	<b>LED Indicators</b>	10 x On board LED indicators 1 x Error LED 1 x Power LED 2 x Ethernet Link/Speed 2 x Port A TX/RX 2 x Port B TX/RX 1 x Button A indicator 1 x Button B indicator
<b>Switch B</b> (SWB)	1 x DIP-Switch for serial EIA485 configuration: Position 1: ON: 120 Ω termination active Off: 120 Ω termination inactive Position 2-3: ON: Polarization active Off: Polarization inactive		

## 6 Dimensions

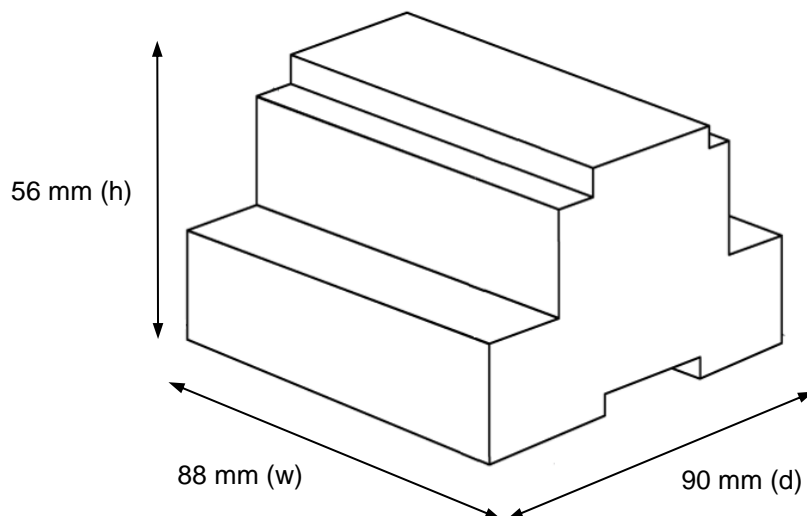

Recommended available space for its installation into a cabinet (wall or DIN rail mounting), with space enough for external connections

