



LUPUSC - VOLANSC AND BROWN VERSIONS

Compact radio transmitters for
wireless intrusion detection
systems

090030459



IT08020000001624



FOREWORD

FOR THE INSTALLER:

Comply strictly with current standards governing the installation of electrical systems and security systems, and with the manufacturer's directions given in the manuals supplied with the products.

Provide the user with full information on using the system installed and on its limitations, pointing out that there are different levels of security performance that will need to suit the user's requirements within the constraints of the specific applicable standards. See that the user looks through the warnings given herein.

FOR THE USER:

Check the system's operation thoroughly at regular intervals, making sure the equipment can be armed and disarmed properly.

Make sure the system receives proper routine maintenance, employing the services of specialist personnel who meet the requirements prescribed by current regulations.

Ask your installer to check that the system suits changing operating conditions (e.g. changes in the extent of the areas to be protected, change in access methods, etc...).

This device has been designed, built and tested with the utmost care and attention, adopting test and inspection procedures in accordance with current legislation. Full compliance of the working specifications is only achieved in the event the device is used solely for its intended purpose, namely:

Compact radio transmitters for wireless intrusion detection systems

The device is not intended for any use other than the above and hence its correct functioning in such cases cannot be assured.

Consequently, any use of the manual in your possession for any purpose other than those for which it was compiled - namely for the purpose of explaining the product's technical features and operating procedures - is strictly prohibited.

Production processes are closely monitored in order to prevent faults and malfunctions. However, the componentry adopted is subject to an extremely modest percentage of faults, which is nonetheless the case with any electronic or mechanical product.

Given the intended use of this item (protection of property and people), we invite you to adapt the level of protection offered by the system to suit the actual situation of risk (allowing for the possibility of impaired system operation due to faults or other problems), while reminding you that there are specific standards for the design and production of systems intended for this kind of application.

We hereby advise you (the system's operator) to see that the system receives regular routine maintenance, at least in accordance with the provisions of current legislation, and also check on as regular a basis as the risk involved requires that the system in question is operating properly, with particular reference to the control unit, sensors, sounders, dialler(s) and any other device connected. You must let the installer know how well the system seems to be operating, based on the results of periodic checks, without delay.

Work involved in the design, installation and maintenance of systems incorporating this product should be performed only by personnel with suitable skills and knowledge required to work safely so as to prevent any accidents. It is vital that systems be installed in accordance with current legislation. The internal parts of certain equipment are connected to the mains and therefore there is a risk of electrocution when maintenance work is performed inside without first disconnecting the primary and emergency power supplies. Certain products include batteries, rechargeable or otherwise, as an emergency backup power supply. If connected incorrectly, they may cause damage to the product or property, and may endanger the operator (explosion and fire).

EU DECLARATION OF CONFORMITY

Hereby, EL.MO. S.p.A. declares that the radio equipment LUPUSC - VOLANSC is in compliance with Directive 2014/53/EU. The full text of the EU declaration of conformity is available at the following Internet address: elmospa.com – registration is quick and easy.

DISPOSAL INSTRUCTIONS - INFORMATION FOR THE USER



IT08020000001624

In accordance with Directive 2012/19/EU on waste electrical and electronic equipment (WEEE), please be advised that the EEE was placed on the market after 13 August 2005 and must be disposed of separately from normal household waste.

This product needs batteries for correct functioning. Exhausted batteries have to be delivered to dumping grounds authorized for battery collection. The materials used for this product are very harmful and polluting if dispersed in the environment.



1. GENERALS

LUPUSC and VOLANSC are compact transmitters used for the control of fixtures or perimetral protections. These transmitters can be included in wireless systems managed by HELIOS, Villeggio or Villeggio NG-TRX control units or by other expressly compatible control unit models. Their general features can be summarized as follows:

- LUPUSC can transmit the state variations of magnetic contacts and of the roll-up shutter sensor wired to its terminals. It uses different transmission codes for a better identification of the alarmed device. It features a REED magnetic contact (on a side); the internal REED contact can be selected as an alternative to the terminal board input. You can also program the rolling shutter input in order to use it for connecting an additional magnetic contact.
- VOLANSC can transmit the state variations of magnetic contacts and of the roll-up shutter sensor wired to its terminals. It uses different transmission codes for a better identification of the alarmed device. It features a REED magnetic contact (on a side); the internal REED contact can be selected as an alternative to the terminal board input. It also has a built-in piezo sensor with adjustable sensitivity, to be used as an alternative to or together with the rolling shutter sensor.

Upon request, the “M” brown version is also available.

A dip switch selector can be used to set the communication protocol (by default, HELIOS).

Note: Set the HELIOS protocol for Villeggio control units whose firmware version is lower than 5.0.0; use the Villeggio protocol with Villeggio control units equipped with firmware version 5.0.0 or higher, or with other compatible devices.

The devices have an identification code (programmed by factory default) in order to further accelerate the installation operations; the memorized code is randomly chosen among more than 2 milliard combinations.

The transmitters also send communications for low battery, tampering (due to housing opening) and supervision.

The codes are transmitted over a frequency for low power devices (LPD).

The operating range for these devices is evaluated in open field with no obstacles, nevertheless the actual range might be reduced in case the device is installed in indoor locations with peculiar architectural features; the nominal range is 160 m for LUPUSC and VOLANSC. The autonomy is in the order of years of functioning, according to the features of each device.

2. FEATURES

Model	LUPUSC	VOLANSC
Protection class	IP3X	
Performance level	Level 1 CEI 79-2, EN50131-5-3 grade 1.	
Power supply voltage	3.6 V supplied by 1/2 AA 3.6 V lithium battery.	
Low battery threshold	2.65 V	
Minimum operating voltage	2.3 V for the transmitter; 2.7 V for the LED indicator.	
Power consumption @ 3.6 V	6.5 μ A idle, 14.5 mA max.	8 μ A idle, 14.5 mA max.
TX frequency	Digital transmissions over the frequencies for LPD devices.	
Maximum TX power	10 mW	
Connection range	160 m in open field, subject to limitations depending on environmental conditions.	
Average autonomy	4.5 years with HELIOS protocol. 5.5 years with Villeggio protocol.	3.5 years with HELIOS protocol. 4.5 years with Villeggio protocol.
	Note: for the calculation, 20 total transmissions per day and a supervision transmission every 25 min are considered.	
Inputs	NC input for magnetic contacts. NC input set by default for connection of rolling shutter sensors (it can be used as an additional magnetic contact input, by setting dip 3 to ON). NC Tamper input.	NC input for magnetic contacts. NC input for connection of rolling shutter sensors (to be used also in combination with the built-in piezo sensor). NC Tamper input.
Wiring length with 2 \times 0.22 mm ² cable	Rolling shutter input: limited to 1 m in total; magnetic contact zone: 20 m max.	



Model	LUPUSC	VOLANSC
Special operating features and controls		Piezo detector included in the printed circuit board, with impact sensitivity control and LED indicator for detected pulses.
Controls		Impact sensitivity adjustment via trimmer. Alarm after detection of 5 pulses within 15 s. Filtering of the pulses with frequency higher than 1 Hz.
Settings	The rolling shutter sensor input sensitivity is set to 5 pulses in 15 s by factory default.	
Selections	On-board REED magnetic contact enabling (on one side only).	
LED indications	Blue front LED.	Yellow front LED, used also for piezo sensor pulses visualization.
TX protocol	The transmitter features a dip switch selector to set the protocol: set dip 2 to OFF for the HELIOS protocol (default), to ON for the Villeggio protocol. Note: set the HELIOS protocol for Villeggio control units whose firmware version is lower than 5.0.0; use the Villeggio protocol with Villeggio control units equipped with firmware version 5.0.0 or higher, or with other compatible devices.	
TX encoding	The transmitter has an identification code randomly chosen in test phase among 2 milliard combinations (2^{31}).	
Transmissions for	Magnetic contact alarm code (with different reset transmission from the rolling shutter input transmission code).	The same as LUPUSC; in addition, transmissions for impact detection from built-in piezo sensor.
Standard transmissions for	Supervision (periodical, in steps of 25 min); tampering events due to housing opening; low battery state (the code is sent upon the first transmission).	
Operating temperature	-10 / +45 °C guaranteed by manufacturer - 93 % Rh	
Dimensions	Transmitter: W 77 × H 40 × D 26 mm; magnet: W 51 × H 9 × D 11 mm.	
Weight	58 g (battery and magnet).	
Parts supplied	4 self tapping screw 2.9 × 13, 1/2 AA 3.6 V lithium battery to be installed in the transmitter, magnet, technical manual.	

LUPUSC and VOLANSC are accessories for Villeggio control units and other expressly compatible devices.

These transmitters are suitable for indoor installation only. Do not install them in locations where they may be affected by condensation phenomena, for example directly on balconies.

3. FIRST POWER-ON OR BATTERY REPLACEMENT

Particular care is required during the first powering phase.
The operations to be performed are listed in the next steps:

1. Insert the 3.6 V battery (supplied as standard equipment) checking the correct polarity.
2. Press and release the Tamper button 3-4 times.
3. Reset any memory of low battery on the control unit or on the compatible receiving device.

WARNING: in case you use a new battery or a battery that has not been used for a long time, a wrong indication of low battery may occur at first activations. Such issue is related to the chemical features of Lithium Thionyl Chloride batteries and it can be solved implementing the above operations.

In case of usage in low temperature locations, we suggest that you keep the battery at room temperature before insertion.



4. MECHANICAL FEATURES

View of the transmitter plastic housing and of the external magnet.

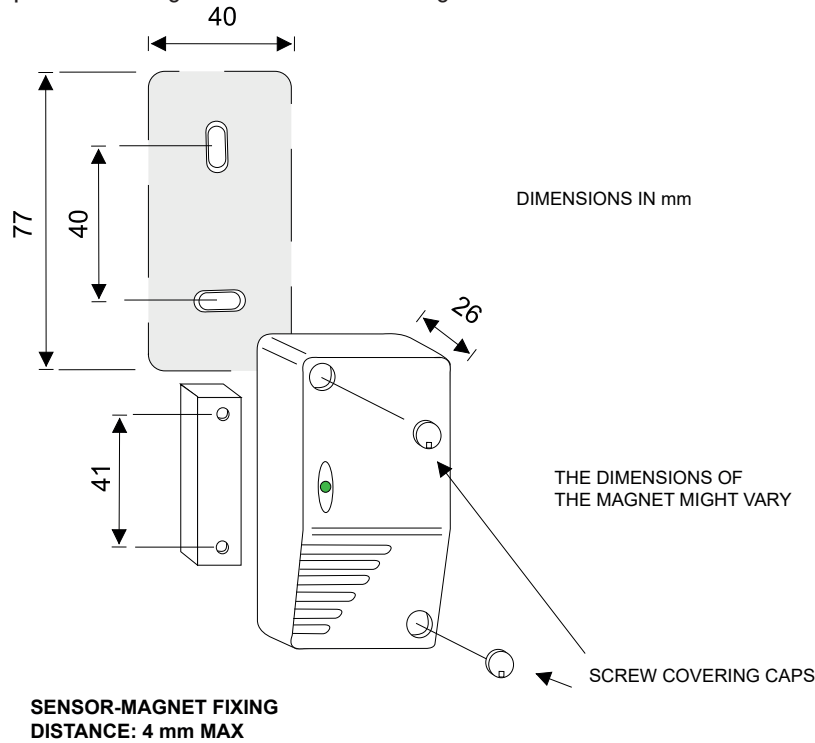

5. HOW TO DISTINGUISH THE DEVICES

The following picture shows the differences between the two transmitters.

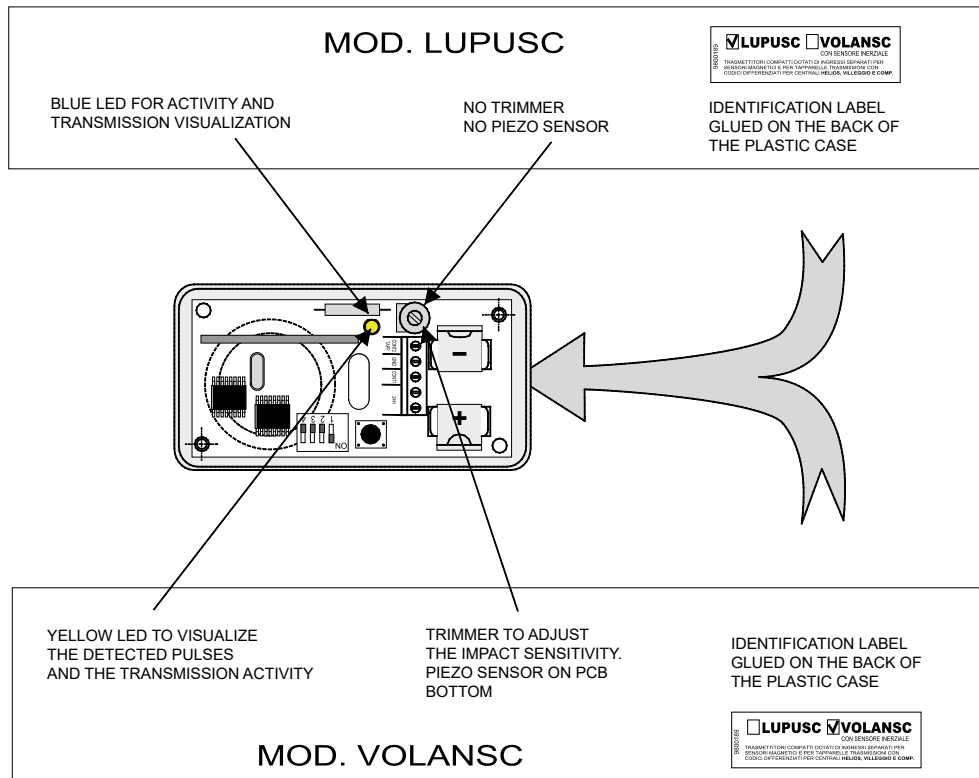



6. INSTALLATION



The installer shall verify that no electrostatic charges are present upon housing opening; internal electronic boards and accessory components may be damaged by such charges. The same care shall be used during installation, updates and maintenance procedures.

The detector installation must comply with certain rules in order to avoid performance drops due to positioning errors. Indeed, it is very important to define with the utmost care the operating area of the receiving system in which the detector is installed, the actual coverage of the sensors and the correct installation, especially in relation to the nature of the materials used in the building construction.

The following pictures show correct and wrong installation positions, objects that may attenuate RF signals and attenuation in some building materials.

Installing situations:

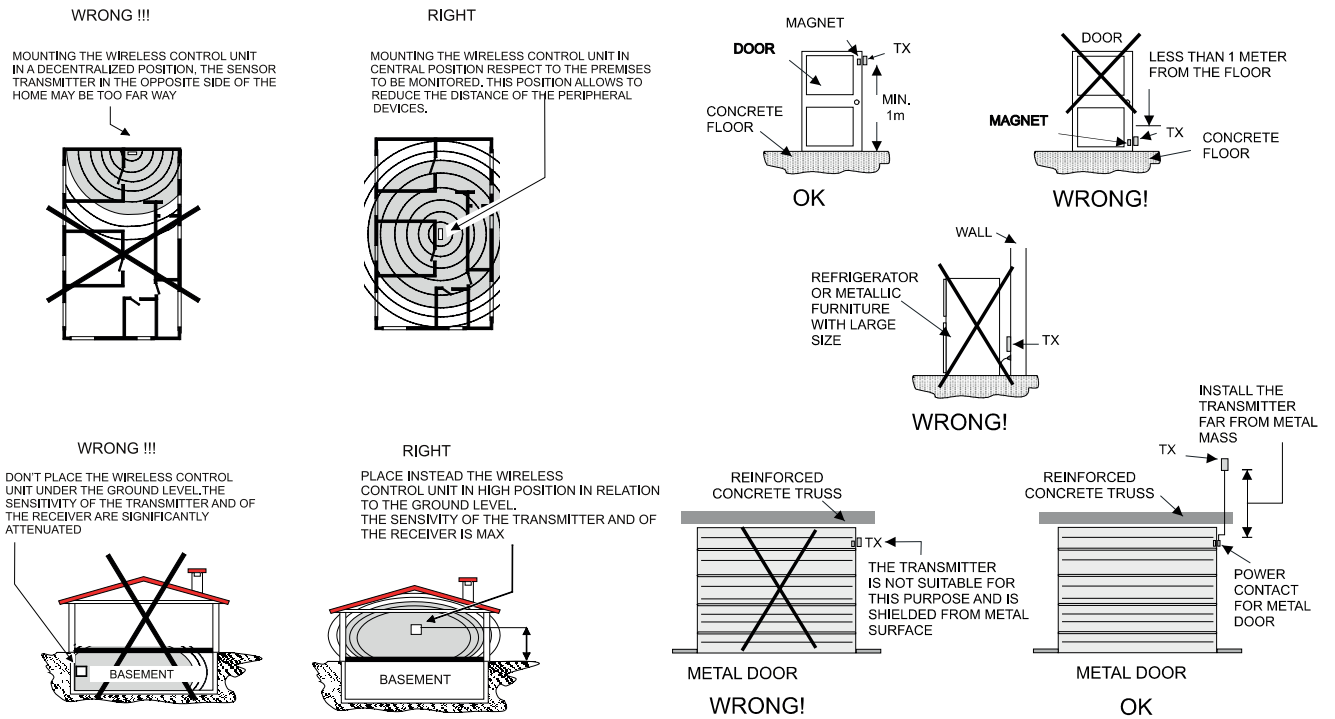

Attenuation of the radio signal in some typical construction materials.

90% - 100%
FULL
POWER

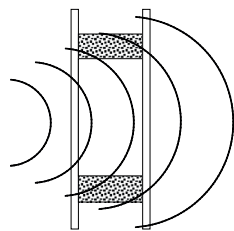

PLYWOOD OR HONEYCOMB WALLS

65% - 95%
FULL
POWER

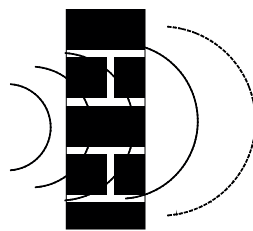

FULL OR DRILLED BRICKS



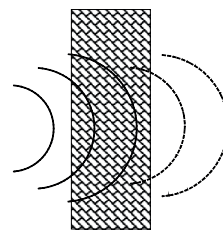

0% - 70%
FULL
POWER





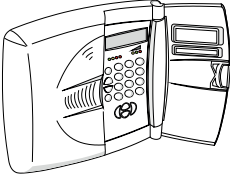
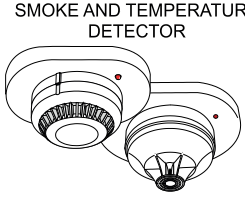
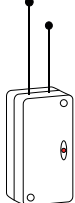
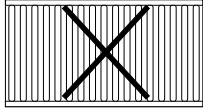

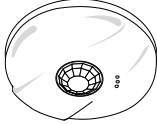
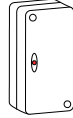
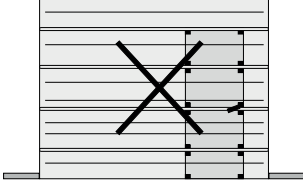
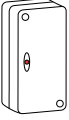
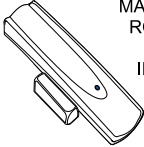
CONCRETE OR SHEET METAL AND PLASTER

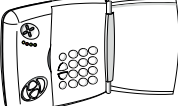
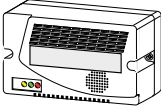
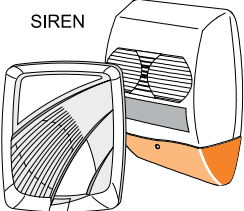
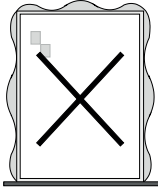

Items that can modify and/or reduce the range, with HELIOS control units.

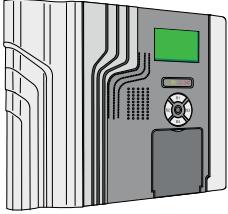
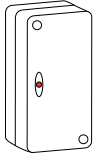
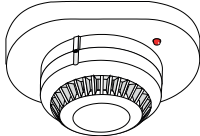
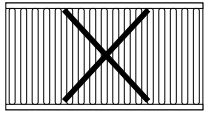
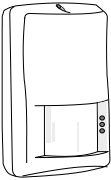
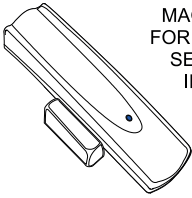
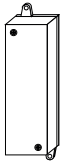
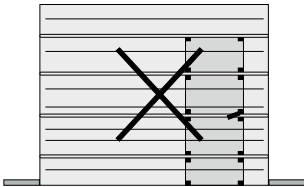
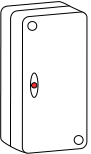
 WIRELESS CONTROL UNIT	 SMOKE AND TEMPERATURE DETECTOR	 RX / TX WIRELESS HEAD	 METAL GRIDS (EG. BASEMENT WINDOW WELLS) AND REINFORCED CONCRETE WALLS
 IR DETECTOR	 CEILING IR DETECTOR WITH 360° PROTECTION	 TRANSMITTER WITH TERMINAL INPUT	 METAL DOOR
 ACTUATOR	 TRANSMITTERS FOR MAGNETIC CONTACT, ROLL-UP SHUTTER SENSORS AND IMPACT INERTIAL	 TRANSMITTER WITH BUILT-IN MAGNETIC CONTACT	
 CONTROL KEYBOARD	 WIRELESS GAS DETECTOR	 SIREN	 MIRRORS

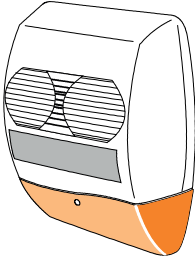
Items that can modify and/or reduce the range, with Villeggio control units.

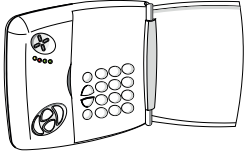
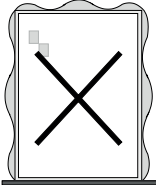
 WIRED-WIRELESS CONTROL UNIT	 ACTUATOR	 SMOKE DETECTOR	 METAL GRIDS (ES. BASEMENT WINDOW WELLS) AND REINFORCED CONCRETE WALLS
 IR DETECTOR	 TRANSMITTER FOR MAGNETIC CONTACT, FOR ROLL-UP SHUTTER SENSORS AND FOR IMPACT INERTIAL	 RIVER RF CONCENTRATORS	 METAL DOORS
 TRANSMITTER WITH TERMINAL INPUT	 TRANSMITTER WITH BUILT-IN MAGNETIC CONTACT	 SIREN	
 TRANSMITTER WITH TEMPERATURE SENSOR	 CONTROL KEYBOARD		 MIRRORS



7. COVERAGE AND SENSITIVITY

Before installing the VOLANSC sensor, carefully consider the maximum sensitivity that can be obtained based on the surface to be protected with its integrated piezo sensor. For this purpose it is useful to refer to the following table:

Surface material	Radius
Brick wall	1 m
Steel	3 m
Wood	3 m
Concrete	30 cm
Plywood	3 m
Glass *	3 m

* The glass test was conducted after sticking the sensor with very adhesive double-sided tape. When installed on glass surfaces, the VOLANSC transmitter is suitable for detecting impact but not for cut and perforations.

Installation of VOLANSC transmitter on a glass panel:

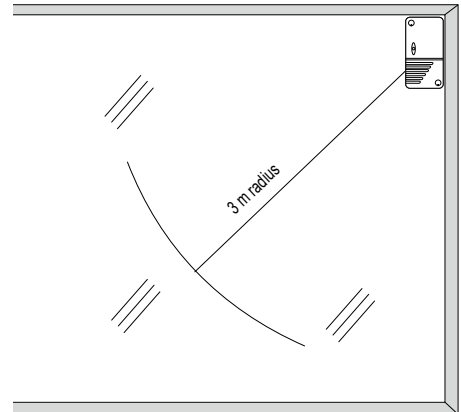

8. MOUNTING

8.1 Housing drilling for cable passing

The following picture shows the sequence of operations to be performed to drill the device housing for cable passing.

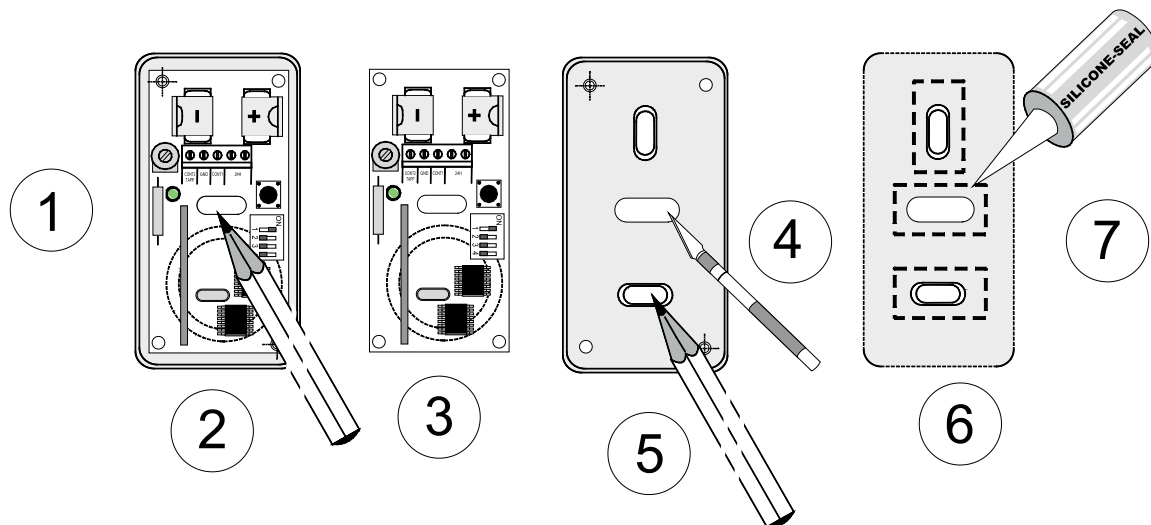

1. Open the device and store the cover in a safe place.
2. Draw the shape of the oval hole (located below the terminal board) on the housing bottom, by following its edge with a thin-tip pencil.
3. Remove the electronic board and store it. If you are using VOLANSC, be careful not to damage the piezo section on the bottom side of the board.
4. Cut the housing bottom with a suitable tool. Make a bigger slot than the sketch you have drawn.
5. Lean the housing bottom against the wall in the installation position. Mark the holes if you need to use screws to fix the housing to the surface.
6. Perform the fixing; feed any required cable.
7. Pour a drop of silicone around the eyelets on the bottom—e.g. the cable input hole and the fixing holes—in order to provide an isolating seal against accidental moisture penetration.

After these operations, proceed with wirings, powering, software configuration. Close the housing making sure to fit the closing spring belonging to the Tamper protection microswitch properly in place. Finally, move ahead with testing.



Example of LUPUSC transmitter mounting inside the housing of a roll-up shutter. One of the possible fixing positions is indicated in the picture on the right.

Search the best position in order to easily replace the battery when needed: a possible position could be the external side of the box.

If you need an additional fixing support, avoid using a metal one in order not to worsen the radio signal.

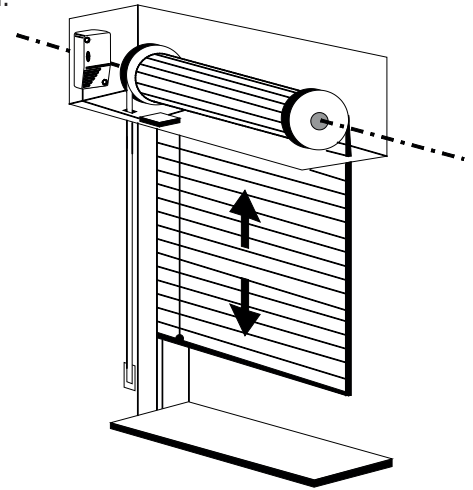

9. ELECTRICAL WIRINGS

Board general view.

TRANSMISSION ACTIVITY LED: 10 FLASHES AT FIRST POWERING, SINGLE FLASH FOR EACH TRANSMISSION

YELLOW LED FOR VOLANSC
BLUE LED FOR LUPUSC

ON VOLANSC ONLY: IMPACT SENSITIVITY ADJUSTMENT (THE PIEZO SENSOR IS LOCATED ON BOARD BOTTOM)

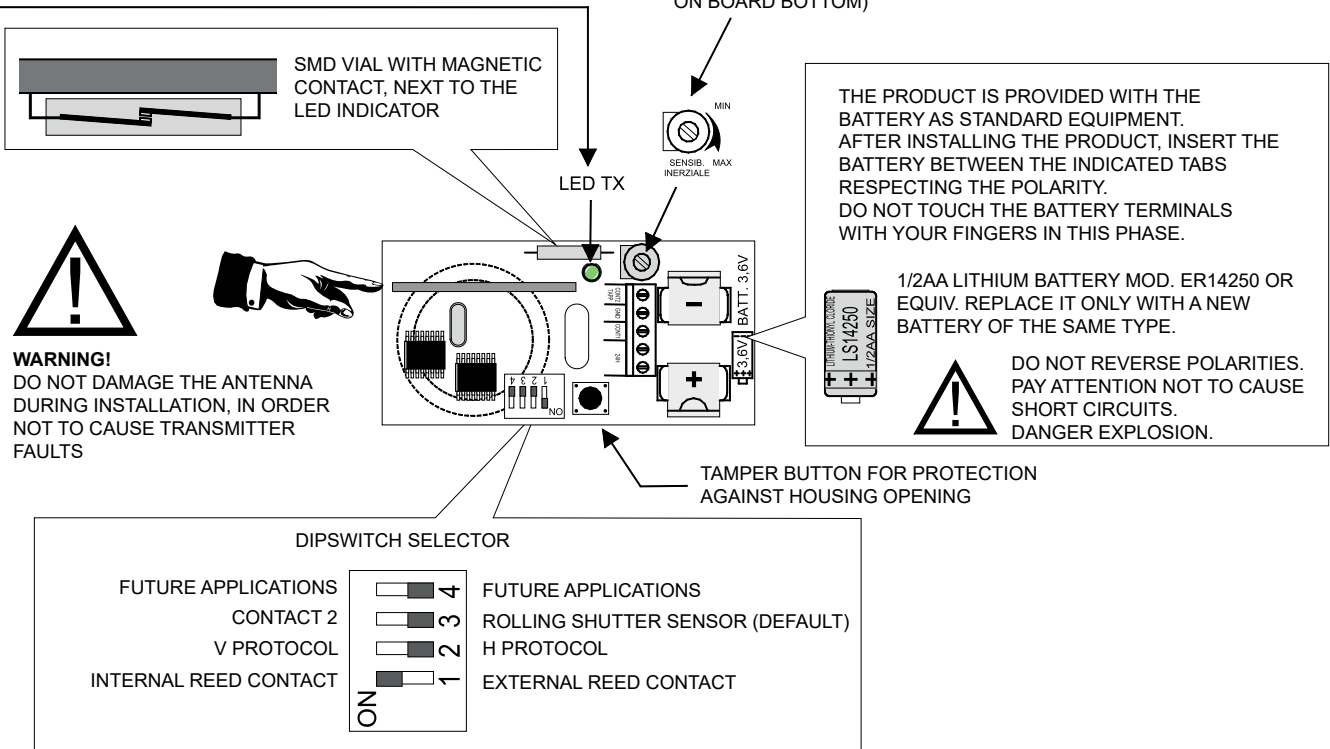



View of the LUPUSC transmitter board, interior layout and general connection, see the detail in the following drawings.

FUNCTION SELECTOR - TABLE SHOWING THE MEANINGS OF THE DIPS

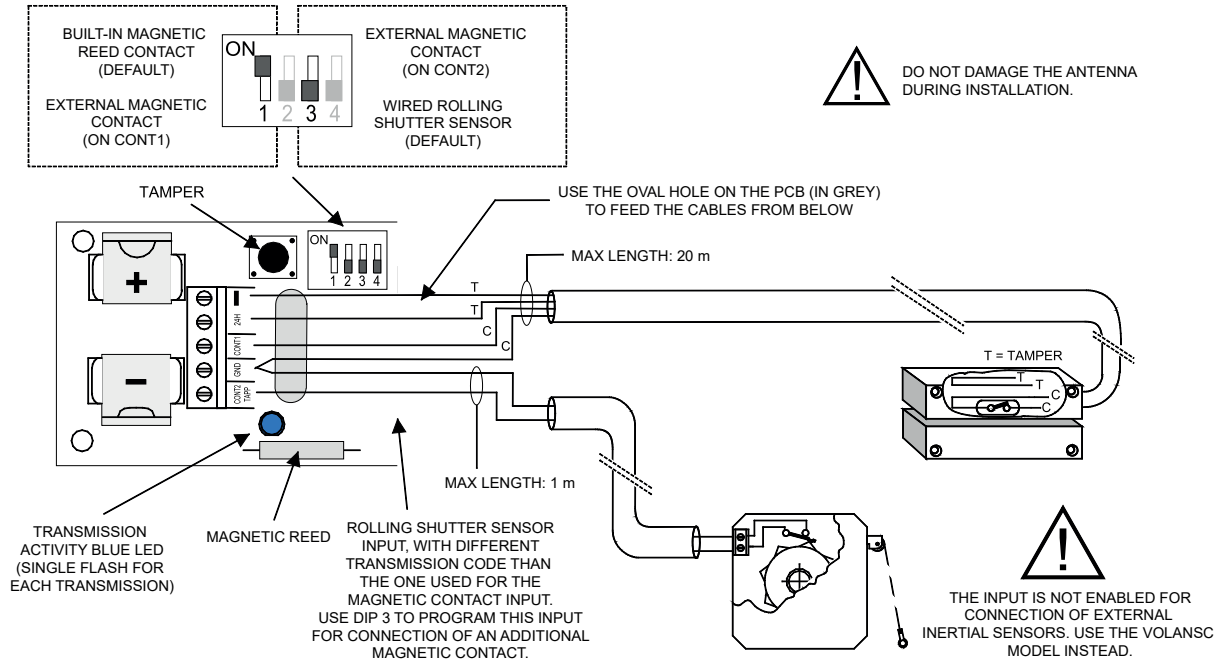

View of the VOLANSC transmitter board, interior layout and general connection, see the detail in the following drawings.

FUNCTION SELECTOR - TABLE SHOWING THE MEANINGS OF THE DIPS

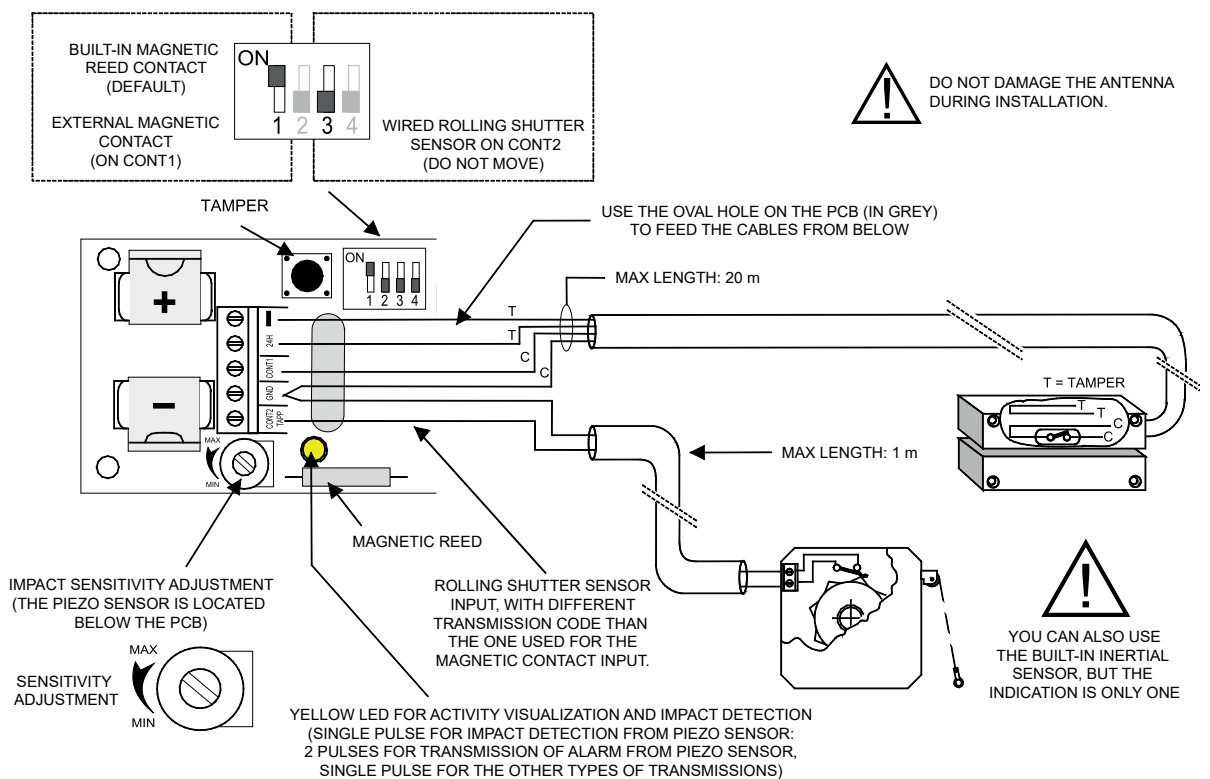

Note: for the VOLANSC transmitter, if dip 3 is set to ON, you would lose the piezo detector operation in order to allow the external magnetic contact management on CONT2.



9.1 Allowed wiring types for LUPUSC

Only on-board magnetic contact.

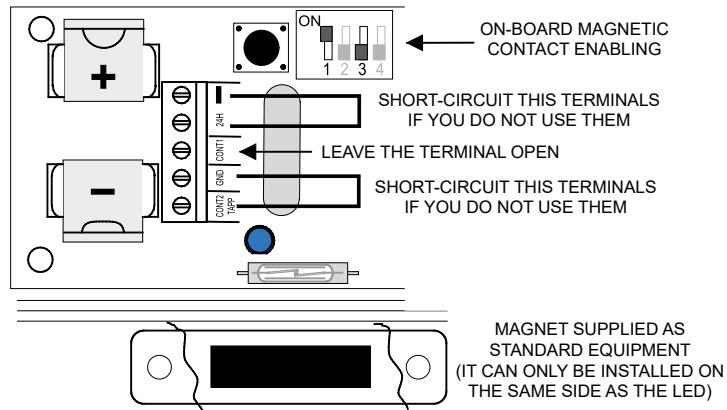

Only external magnetic contact.

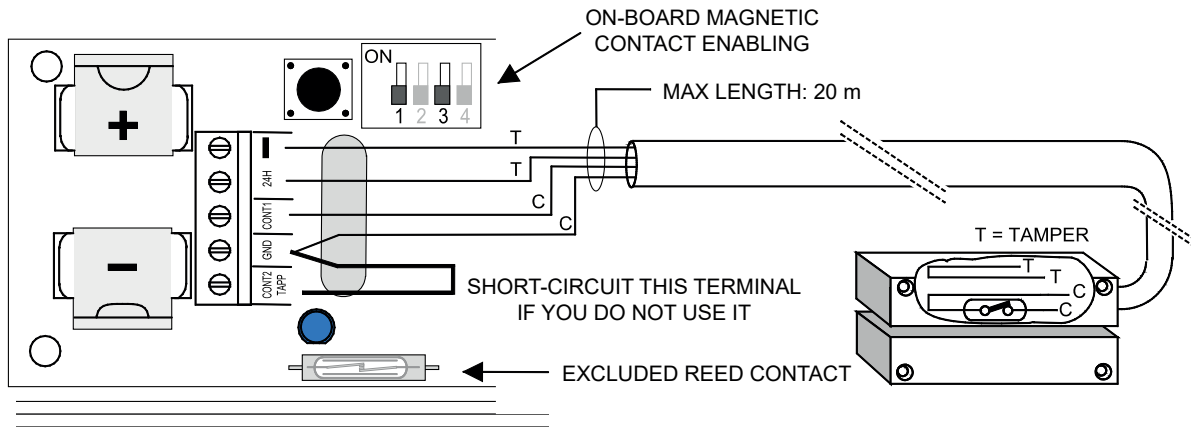

On board and external magnetic contact.

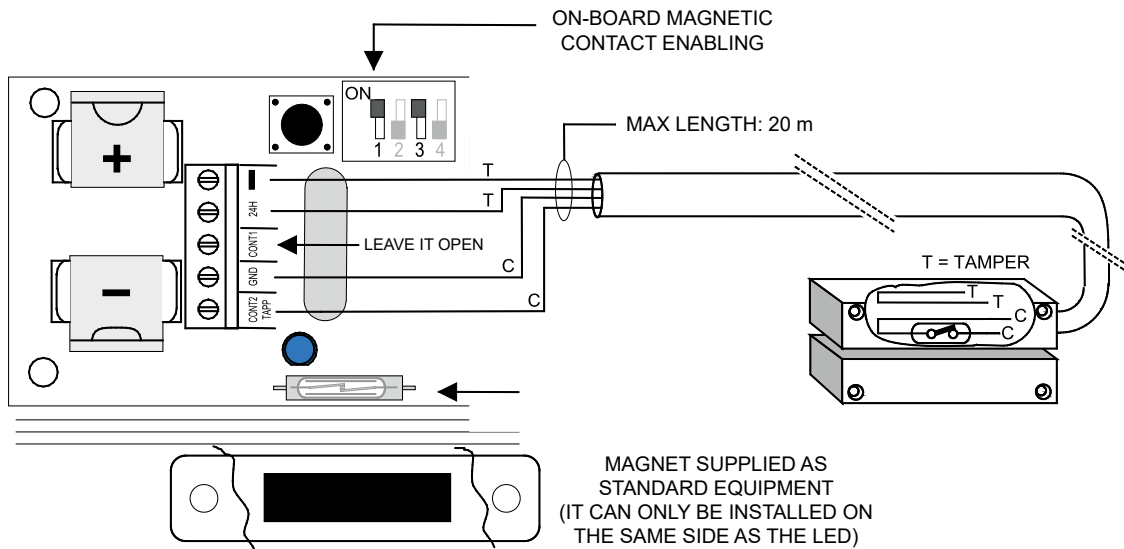



Only external magnetic contacts, use of the two terminal inputs.

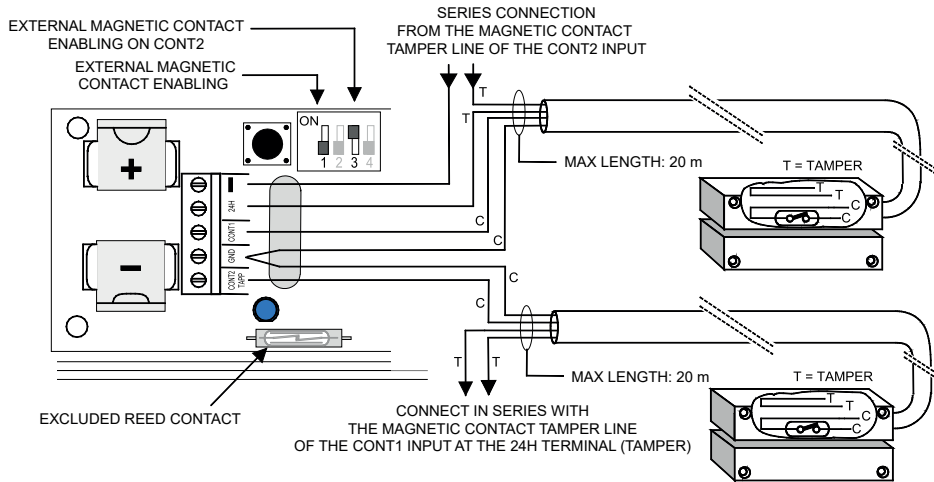

On-board magnetic contact and rolling shutter sensor.

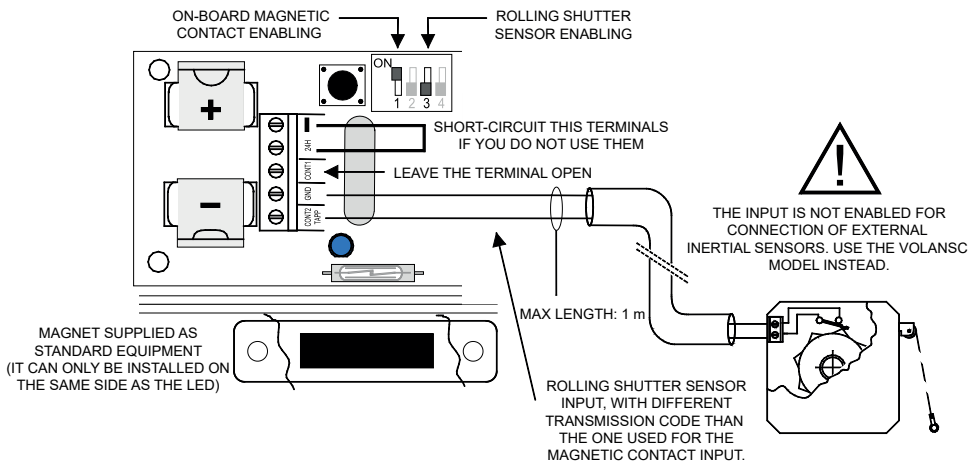

External magnetic contact and roller shutter sensor.

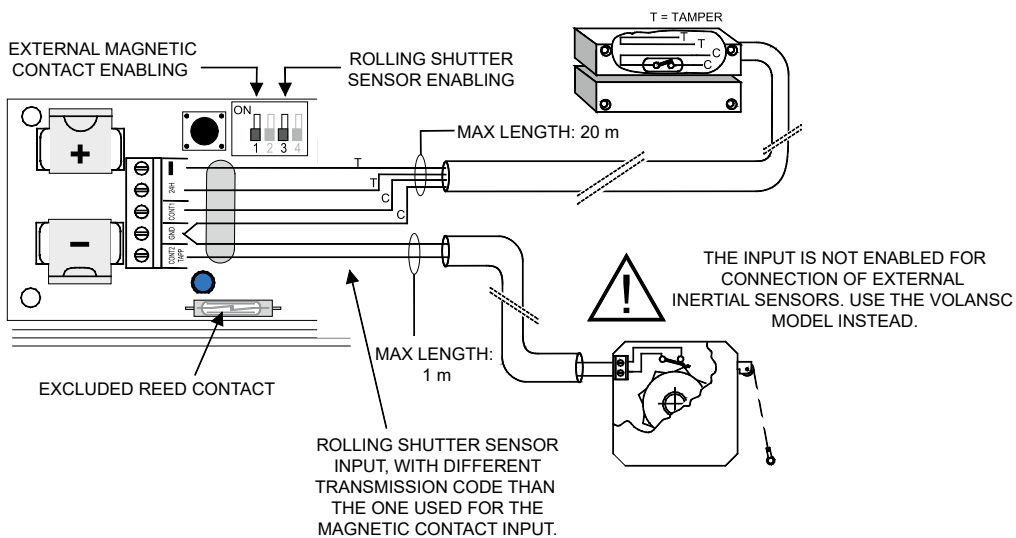

Note: in order to ensure the product certification, it is necessary to wire the Tamper protection lines of the external magnetic contact and of the rolling shutter sensor to the proper terminal on the transmitter board.



9.2 Allowed wiring types for VOLANSC

Magnetic contact and on-board inertial sensor.

THE PIEZO SENSOR IS LOCATED IN THIS POSITION.
 WARNING:
 TO GET THE HIGHEST SENSITIVITY, SET THE HOUSING BOTTOM PERFECTLY IN CONTACT WITH THE SURFACE TO BE PROTECTED

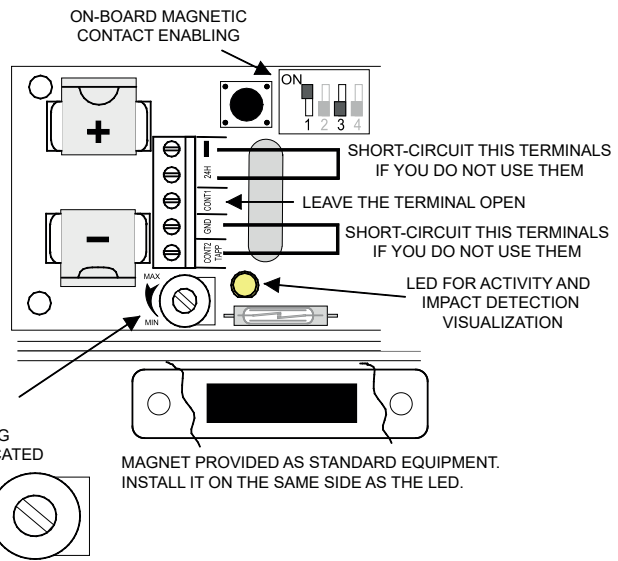
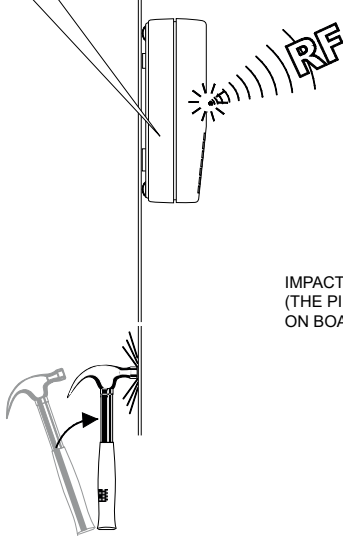

WITH THIS WIRING, IT IS POSSIBLE TO MANAGE ALARMS FROM THE BUILT-IN MAGNETIC CONTACT AND THE GLASS BREAKING DETECTION; THE SENSITIVITY CAN BE ADJUSTED USING THE TRIMMER AT THE SIDE OF THE REED CONTACT.

External magnetic contact and on-board inertial sensor.

THE PIEZO SENSOR IS LOCATED IN THIS POSITION.
 WARNING:
 TO GET THE HIGHEST SENSITIVITY, SET THE HOUSING BOTTOM PERFECTLY IN CONTACT WITH THE SURFACE TO BE PROTECTED

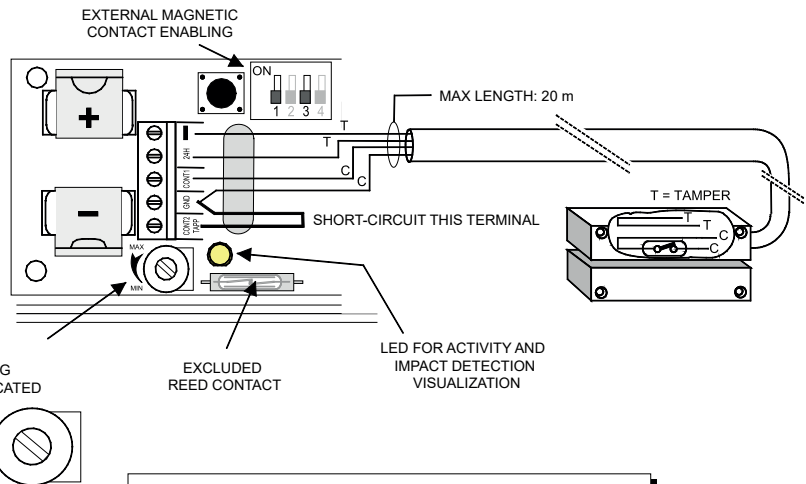
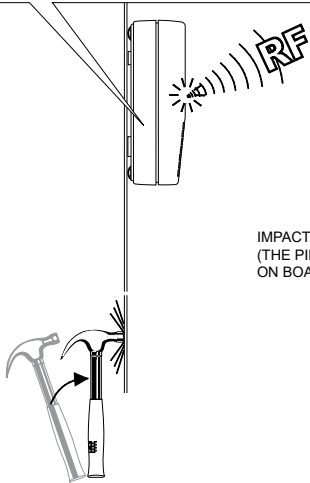

WITH THIS WIRING, IT IS POSSIBLE TO MANAGE ALARMS FROM THE BUILT-IN MAGNETIC CONTACT AND THE GLASS BREAKING DETECTION; THE SENSITIVITY CAN BE ADJUSTED USING THE TRIMMER AT THE SIDE OF THE REED CONTACT.



External magnetic contact, external shutter sensor and on-board inertial sensor.

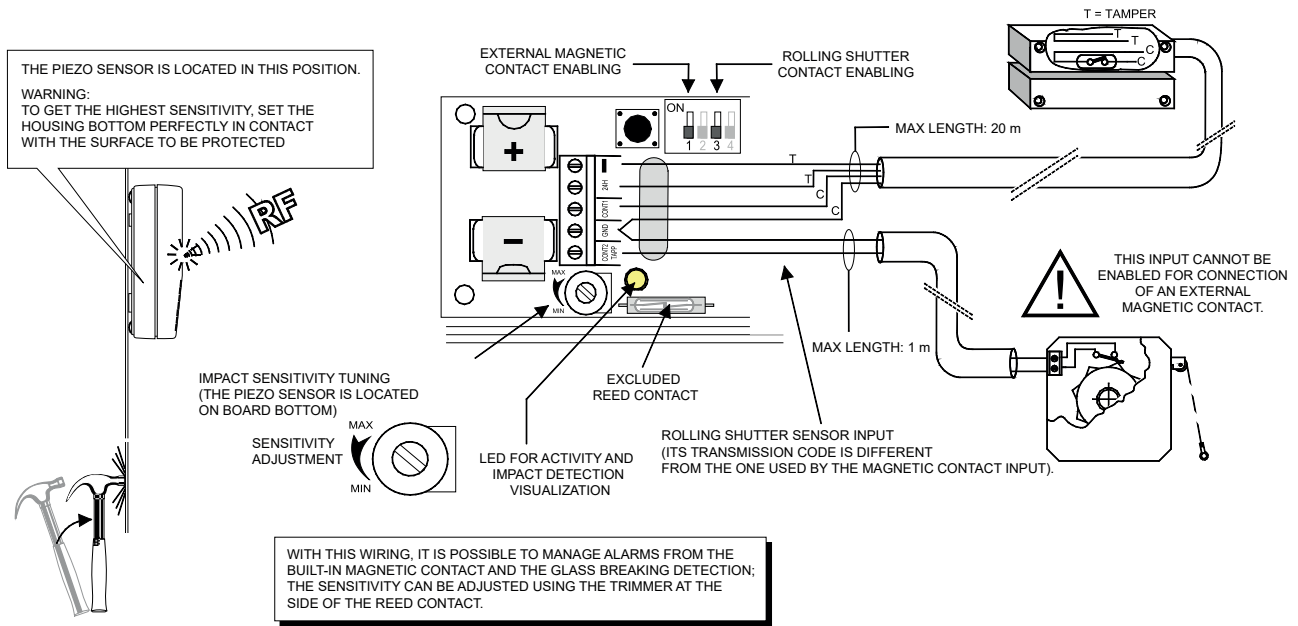

Note: you can not use the VOLANSC transmitter with a second external magnetic contact connected to CONT2 terminal (dip 3 must always be in OFF position), otherwise you cannot manage the internal piezo sensor.

Only on-board inertial sensor.

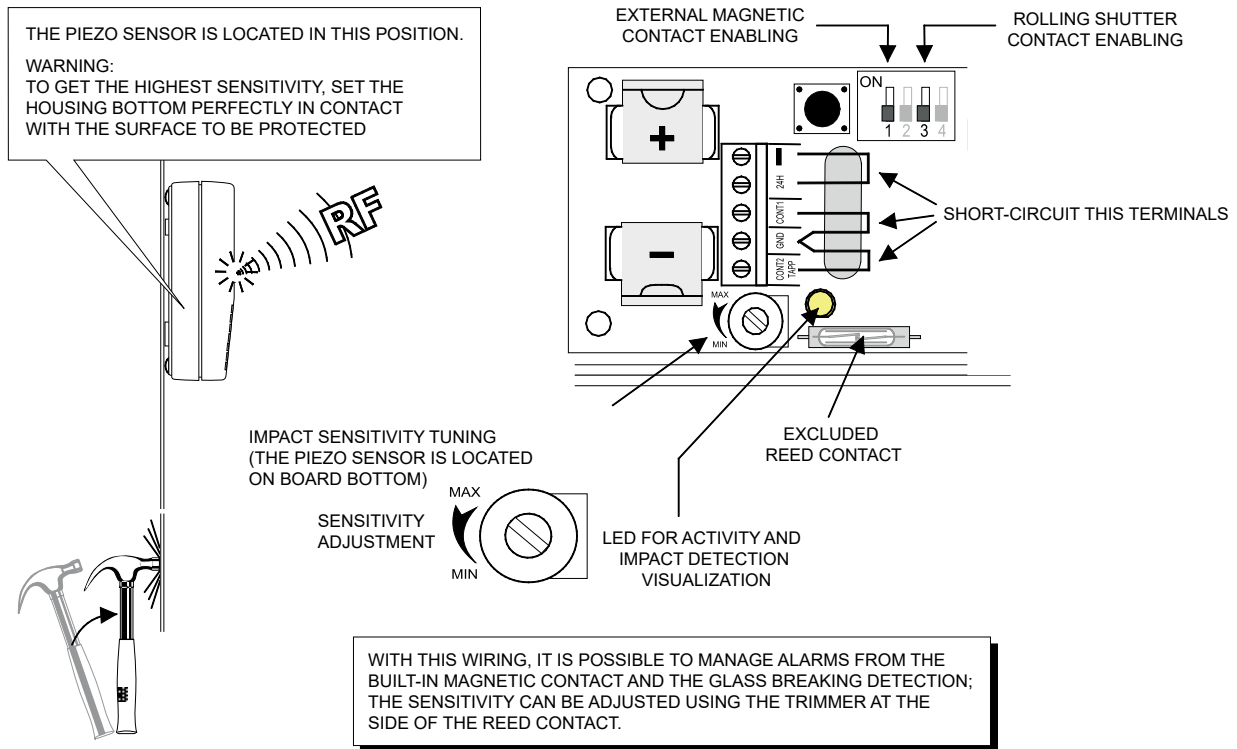

Note: in order to ensure product certification, it is necessary to wire the Tamper protection lines of the external magnetic contact and of the rolling shutter sensor to the proper terminal on the transmitter board.



10. SETUP PROCEDURE

10.1 Communication protocol setting

LUPUSC and VOLANSC can be used in wireless systems having HELIOS, Villeggio control units or other compatible models as control units. In order to successfully send the codes of the generated events, it is necessary to correctly set the communication protocol. For this purpose, use dip 2:

VILLEGGIO PROTOCOL **Note:** use this protocol with Villeggio control units equipped with firmware version 5.0.0 or higher, and with other expressly compatible devices.



HELIOS PROTOCOL (DEFAULT) **Note:** use this protocol with Villeggio control units equipped with firmware version lower than 5.0.0.

WARNING: a wrong position of the dip will not allow intelligible transmission to the control unit.

Note: The Villeggio protocol (usable only with compatible devices) improves communication reliability and battery life.

10.2 Transmitter storing procedure with compatible control unit

- A. Open the plastic housing of the transmitter.
- B. If necessary, perform the setup procedure as specified in the previous paragraph using the supplied battery.
- C. Enter in programming mode from the compatible control unit, reaching the radio device acquisition menu.
- D. Cause a transmission by pressing and holding the Tamper button: ***in this way, you will send the recognition code for the magnetic sensor wired to the transmitter terminal, or for the on-board magnetic contact (if previously enabled using dip 1).***

Note: if you only need to control the magnetic sensor and not the shutter sensor, exit from the programming mode and then release the TAMPER button.

Attention: if you do not press the TAMPER button in the correct sequence (i.e. with a **press-and-release operation**), the transmitter code will be incorrectly stored, therefore it will be necessary to delete the last stored transmitters and then correctly repeat the operation.

While keeping the TAMPER button pressed, use the control unit menu again to add a new transmitter. Activate the recognition of the new transmitter.

- E. Release the TAMPER button.
The control unit recognizes that the code received from the rolling shutter sensor coincides with the code of the piezo inertial sensor of the VOLANSC transmitter. Exit from the programming in the usual way.
- Note:** if you are using a LUPUSC and its input is programmed as magnetic contact, releasing the TAMPER button will transmit to the control unit the code of the second magnetic contact input.
- F. Once the transmitter code is stored, you can set the device functions.
- G. Install the transmitter in locations allowed for this purpose. For this purpose, consult the drawings in the "6. INSTALLATION" chapter on page 6, checking the proper functioning through test transmissions.
- H. Close the transmitter housing checking the Tamper button is perfectly pressed.

WARNING: the lack of care while closing the case generates a tampering alarm for each supervision transmission and for each transmission of magnetic contact opening/closing.

LUPUSC - VOLANSC - Compact radio transmitters for wireless intrusion detection systems
TECHNICAL MANUAL - November 2013 edition - rev.08-2017

090030459

Product specifications as described above do not bind the manufacturer and may be altered without prior notice.

EL.MO. SpA Via Pontarola, 70 - 35011 Campodarsego (PD) - Italy
Tel. +390499203333 - Fax +390499200306 - Technical Ass. +390499200426 - www.elmospa.com - international@elmospa.com