

Modbus RTU (EIA-485) Interface for Panasonic Air to Water systems

Compatible with Panasonic Aquarea H/J generation models

USER MANUAL

Issue date: 05/2020 r1.3 ENGLISH



Modbus RTU (EIA-485) Interface for Panasonic Air to Water systems

Compatible with Panasonic Aquarea H/J generation models

ORDER CODE	LEGACY ORDER CODE
INMBSPAN001A000	PA-AW2-MBS-1

Important User Information

Disclaimer

The information in this document is for informational purposes only. Please inform HMS Industrial Networks of any inaccuracies or omissions found in this document. HMS Industrial Networks disclaims any responsibility or liability for any errors that may appear in this document.

HMS Industrial Networks reserves the right to modify its products in line with its policy of continuous product development. The information in this document shall therefore not be construed as a commitment on the part of HMS Industrial Networks and is subject to change without notice. HMS Industrial Networks makes no commitment to update or keep current the information in this document.

The data, examples and illustrations found in this document are included for illustrative purposes and are only intended to help improve understanding of the functionality and handling of the product. In view of the wide range of possible applications of the product, and because of the many variables and requirements associated with any particular implementation, HMS Industrial Networks cannot assume responsibility or liability for actual use based on the data, examples or illustrations included in this document nor for any damages incurred during installation of the product. Those responsible for the use of the product must acquire sufficient knowledge in order to ensure that the product is used correctly in their specific application and that the application meets all performance and safety requirements including any applicable laws, regulations, codes and standards. Further, HMS Industrial Networks will under no circumstances assume liability or responsibility for any problems that may arise as a result from the use of undocumented features or functional side effects found outside the documented scope of the product. The effects caused by any direct or indirect use of such aspects of the product are undefined and may include e.g. compatibility issues and stability issues.

INDEX

- 1. Presentation 5
- 2. Connection 6
 - 2.1 Connection to the Hydro unit..... 6
 - 2.2 Connection to the EIA-485 bus 6
- 3. Quick Start Guide..... 7
- 4. Modbus Interface Specification 8
 - 4.1 Modbus physical layer..... 8
 - 4.2 Modbus Registers..... 8
 - 4.2.1 General System Control 8
 - 4.2.2 Zones..... 9
 - 4.2.3 Tank Configuration..... 10
 - 4.2.4 Consumption 11
 - 4.2.5 Maintenance..... 11
 - 4.2.6 Unit Configuration 11
 - 4.2.7 Considerations on Temperature Registers 12
 - 4.2.8 Zones..... 12
 - 4.3 DIP-switch Configuration Interface 13
 - 4.4 Implemented Functions 17
 - 4.5 Device LED indicator 17
 - 4.6 EIA-485 bus. Termination resistors and Fail-Safe Biasing mechanism 18
- 5. Electrical and Mechanical features 19
- 6. List of supported Hydro Unit Types..... 20
- 7. Error Codes 21

1. Presentation



The INMBSPAN001A000 interface allows a complete and natural integration of **Panasonic Air-to-Water Systems** into Modbus RTU (EIA-485) networks.

Compatible with Aquarea H/J models from Panasonic

Reduced dimensions. 93 x 53 x 58 mm.
3.7" x 2.1" x 2.3"

- Quick and easy installation.
Mountable on DIN rail, wall, or even inside the Hydro unit.
- External power not required.
- Direct connection to Modbus RTU (EIA-485) networks. Up to 63 INMBSPAN001A000 devices can be connected in the same network.
INMBSPAN001A000 is a Modbus slave device.
- Direct connection to the Hydro unit. Up to 1 Hydro unit can be connected to INMBSPAN001A000. *The cable for this connection is also supplied.*
- Configuration from both on-board DIP-switches and Modbus RTU.
- Total Control and Supervision.
- Real states of the Hydro unit's internal variables.
- Allows simultaneous use of the remote controls of the Hydro unit and Modbus RTU.

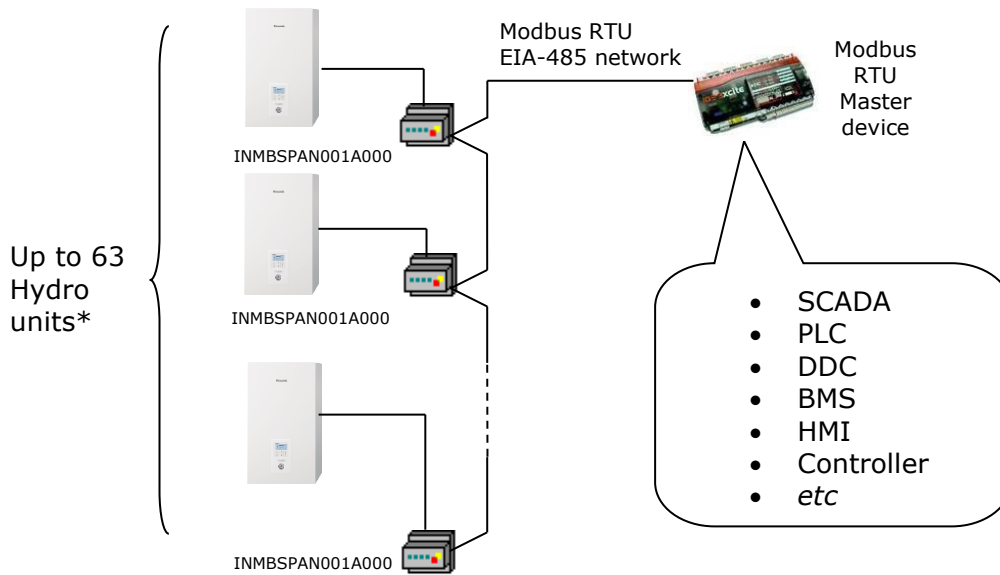

*Up to 63 Intesis devices can be installed in the same Modbus RTU bus. However, depending on the configured speed, the installation of Modbus Repeaters may be required.

2. Connection

The interface comes with a specific cable and connector to establish direct connection with the Aquarea H/J Generation's system. It comes as well with a plug-in terminal block of 2 poles to establish direct connection with the Modbus RTU EIA-485 network.

2.1 Connection to the Hydro unit

To connect the INMBSPAN001A000 interface with the Hydro unit, these steps must be followed:

Disconnect Mains Power from the Hydro unit. Open the front cover of the Hydro unit to have access to the electronic circuit. Once the electronic circuit is reached, locate the socket connector marked as **CN-CNT**.

Take the cable that comes with the interface, insert one of its connectors (the one installed in the shortest uncovered part) into the socket of the INMBSPAN001A000, and the other connector (the one installed in the largest uncovered part) to the socket **CN-CNT** of the Hydro unit's electronic circuit. You can place the INMBSPAN001A000 inside or outside the Hydro unit depending on your needs. Remember that the INMBSPAN001A000 must also be connected to the Modbus RTU EIA-485 network. Close the Hydro unit's front cover again to finish the connection.

Do not modify the length of the cable supplied with the interface, it may affect the correct interface's operation.

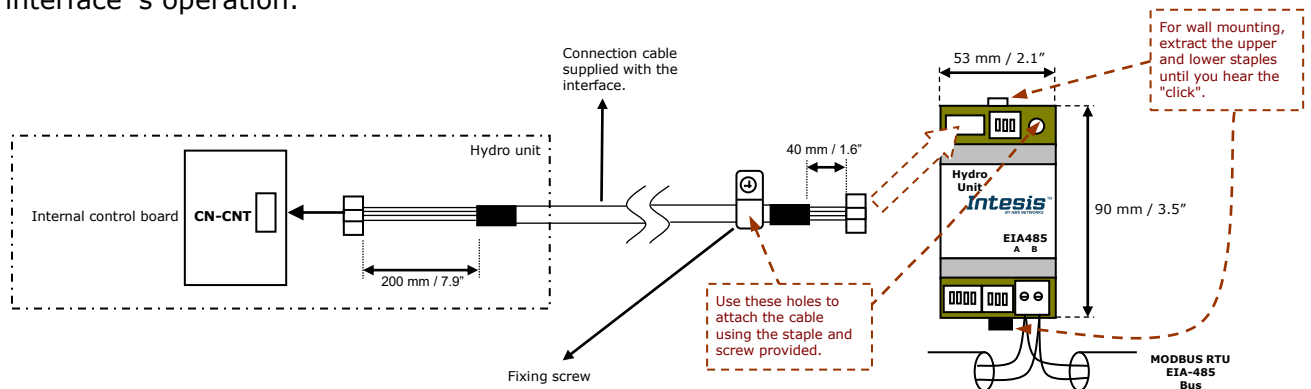

Figure 2.1 INMBSPAN001A000 connection diagram

2.2 Connection to the EIA-485 bus

Connect the EIA-485 bus wires to the plug-in terminal block of INMBSPAN001A000 and keep the polarity on this connection (A+ and B-). Make sure that the maximum distance to the bus is 1,200 meters (3,937 ft). Loop or star typologies are not allowed in the case of the EIA-485 bus. A terminator resistor of 120Ω must be present at each end of the bus to avoid signal reflections. The bus needs a fail-safe biasing mechanism (see section 4.6 for more details).

3. Quick Start Guide

1. Disconnect the Hydro unit from the Mains Power.
2. Attach the interface next to the Hydro unit (wall mounting) following the instructions of the diagram above or install it inside the Hydro unit (respect the safety instructions given by Panasonic).
3. Connect the provided cable of the Panasonic interface between the Hydro unit and the Intesis interface following the instructions of the diagram above.
4. Connect the EIA-485 bus to the connector *EIA485* of the interface.
5. Close the Hydro indoor unit.
6. Check the DIP-Switch configuration of the Intesis interface and make sure it matches the current installation's parameters (see section 4.3).

By default, the interface is set to:

- Modbus Slave Address → 1
- Modbus baud rate → 9600 bps



These parameters can be modified from SW4 and SW3 DIP-Switches.

All other switch positions are set at low level (Off position ) by default.

NOTE: All changes on the DIP-Switch configuration require a system power cycle to be applied.

7. Connect the Hydro unit system to Mains Power.

IMPORTANT: The Intesis interface requires to be connected to the Hydro unit (powered) to start communicating.

4. Modbus Interface Specification

4.1 Modbus physical layer

INMBSPAN001A000 implements a Modbus RTU (Slave) interface, to be connected to an EIA-485 line. It performs 8N2 communication (8 data bits, no parity and 2 stop bit) with several available baud rates (2400 bps, 4800 bps, 9600 bps -default-, 19200 bps, 38400 bps, 57600 bps, 76800 bps and 115200 bps). It also supports 8N1 communication (8 data bits, no parity and 1 stop bit).

4.2 Modbus Registers

All registers are type "16-bit unsigned Holding Register" and they use the standard *Modbus big endian* notation.

4.2.1 General System Control

Register Address (protocol address)	Register Address (PLC address)	R/W	Description
0	1	R/W	System On/Off <ul style="list-style-type: none"> ▪ 0: Off ▪ 1: On (Default)
1	2	R	Outdoor temperature ^{1,2} <ul style="list-style-type: none"> ▪ -127..127°C (°C/x10°C) ▪ -260.6..260.6°F
2	3	R	Outlet water temperature ^{1,2} <ul style="list-style-type: none"> ▪ 0..127°C (°C/x10°C) ▪ 32..260.6°F
3	4	R	Inlet water temperature ^{1,2} <ul style="list-style-type: none"> ▪ 0..127°C (°C/x10°C) ▪ 32..260.6°F
4	5	R/W	Operating mode <ul style="list-style-type: none"> ▪ 1: Heat ▪ 2: Heat Tank ▪ 3: Tank ▪ 4: Cool Tank ▪ 5: Cool ▪ 6: Auto (Default)
		R	<ul style="list-style-type: none"> ▪ 7: Auto Tank ▪ 8: Auto Heat ▪ 9: Auto Heat Tank ▪ 10: Auto Cool ▪ 11: Auto Cool Tank
5	6	R/W	Heat mode water temp. setting method <ul style="list-style-type: none"> ▪ 1: Compensation curve ▪ 2: Direct (Default)
6	7	R/W	Cool mode water temp. setting method <ul style="list-style-type: none"> ▪ 1: Compensation curve ▪ 2: Direct (Default)

¹ Magnitude for this register can be adjusted to Celsius x 1°C, Celsius x 10°C (default) or Fahrenheit.

² It is not possible turn to x10 the value shown in Fahrenheit.

4.2.2 Zones

Register Address (protocol address)	Register Address (PLC address)	R/W	Description
9	10	R/W	Zone 1/Zone 2 On/Off ³ <ul style="list-style-type: none"> ▪ 1: On/Off ▪ 2: Off/On ▪ 3: On/On
10	11	R	Zone 1 sensors ^{3,4} <ul style="list-style-type: none"> ▪ 1: Water temperature ▪ 2: External room sensor ▪ 3: Internal room sensor ▪ 4: Room thermistor ▪ 5: Pool Sensor
11	12	R	Zone 2 sensors ^{3,4} <ul style="list-style-type: none"> ▪ 1: Water temperature ▪ 2: External room sensor ▪ 3: Internal room sensor ▪ 4: Room thermistor ▪ 5: Pool Sensor
12	13	R/W	Zone 1 setpoint temperature ^{3,4} <ul style="list-style-type: none"> ▪ COOL <ul style="list-style-type: none"> ▪ Water shift -5..5°C (°C/x10°C) // -41..41°F ▪ Water 5..20°C (°C/x10°C) // 41..68°F ▪ Room 18..35°C (°C/x10°C) // 64.4..95°F ▪ HEAT <ul style="list-style-type: none"> ▪ Water shift -5..5°C (°C/x10°C) // -41..41°F ▪ Water 20..55/65°C (°C/x10°C) // 68..131/149°F ▪ Room 10..30°C (°C/x10°C) // 50..86°F ▪ Pool 15..35°C (°C/x10°C) // 59..95°F
13	14	R/W	Zone 2 setpoint temperature ^{1,2,3,4} <ul style="list-style-type: none"> ▪ COOL <ul style="list-style-type: none"> ▪ Water shift -5..5°C (°C/x10°C) // -41..41°F ▪ Water 5..20°C (°C/x10°C) // 41..68°F ▪ Room 18..35°C (°C/x10°C) // 64.4..95°F ▪ HEAT <ul style="list-style-type: none"> ▪ Water shift -5..5°C (°C/x10°C) // -41..41°F ▪ Water 20..55/65°C (°C/x10°C) // 68..131/149°F ▪ Room 10..30°C (°C/x10°C) // 50..86°F ▪ Pool 15..35°C (°C/x10°C) // 59..95°F

³ More information about zone 1 and zone 2 on Section 4.2.9⁴ See Section 4.2.8 to understand the options available

Register Address (protocol address)	Register Address (PLC address)	R/W	Description
14	15	R	Zone 1 current temperature ^{1,2,3,4} Water outlet/room/pool <ul style="list-style-type: none"> -127..127°C (°C/x10°C) -260.6..260.6°F
15	16	R	Zone 2 current temperature ^{1,2,3,4} Water outlet/room/pool <ul style="list-style-type: none"> -127..127°C (°C/x10°C) -260.6..260.6°F
16	17	R	Zone 1 temperature setting mode ^{3,4} <ul style="list-style-type: none"> 1: Room temperature 2: Compensation curve (Water Temp) 3: Direct (Water Temp) 4: Pool Temp
17	18	R	Zone 2 temperature setting mode ^{3,4} <ul style="list-style-type: none"> 1: Room temperature 2: Compensation curve (Water Temp) 3: Direct (Water Temp) 4: Pool Temp
18	19	R	Zone 1 min Setpoint temperature ^{1,3} <ul style="list-style-type: none"> Any (°C/x10°C)
19	20	R	Zone 1 max Setpoint temperature ^{1,3} <ul style="list-style-type: none"> Any (°C/x10°C)
20	21	R	Zone 2 min Setpoint temperature ^{1,3} <ul style="list-style-type: none"> Any (°C/x10°C)
21	22	R	Zone 2 max Setpoint temperature ^{1,3} <ul style="list-style-type: none"> Any (°C/x10°C)

4.2.3 Tank Configuration

Register Address (protocol address)	Register Address (PLC address)	R/W	Description
30	31	R/W	Tank On/Off ⁴ <ul style="list-style-type: none"> 0: Off 1: On
32	33	R	Tank current water temperature ^{1,2} <ul style="list-style-type: none"> -127..127°C (°C/x10°C) -260.6..260.6°F
33	34	R/W	Tank water setpoint temperature ^{1,2} <ul style="list-style-type: none"> 40..66/75°C (°C/x10°C) 104..150.8/167°F
34	35	R	Tank heater ⁴ <ul style="list-style-type: none"> 1: Internal 2: External
35	36	R	Tank min water setpoint temperature ^{1,2,4} <ul style="list-style-type: none"> Any (°C/x10°C/F°)
36	37	R	Tank max water setpoint temperature ^{1,2,4} <ul style="list-style-type: none"> Any (°C/x10°C/F°)

4.2.4 Consumption

Register Address (protocol address)	Register Address (PLC address)	R/W	Description
45	46	R	Tank mode energy consumption ⁴ <ul style="list-style-type: none"> 0..50.800 W
46	47	R	Heat mode energy consumption <ul style="list-style-type: none"> 0..50.800 W
47	48	R	Cool mode energy consumption <ul style="list-style-type: none"> 0..50.800 W

4.2.5 Maintenance

Register Address (protocol address)	Register Address (PLC address)	R/W	Description
52	53	R	Error Code ⁵ <ul style="list-style-type: none"> 0: No Error 0xxx: U+err 1xxx: H+err 2xxx: F+err
64	65	R	Device Status <ul style="list-style-type: none"> 1: Off 2: On
70	71	R	Current error status <ul style="list-style-type: none"> 0: No error 1: Error

4.2.6 Unit Configuration

Register Address (protocol address)	Register Address (PLC address)	R/W	Description
81	82	R	Tank connection ⁴ <ul style="list-style-type: none"> 0: No 1: Yes
82	83	R	Number of zones ³ <ul style="list-style-type: none"> 1: 1 zone 2: 2 zones
83	84	R	Zone 1 setup ^{3,4} <ul style="list-style-type: none"> 1: Room 2: Pool
84	85	R	Zone 2 setup ^{3,4} <ul style="list-style-type: none"> 1: Room 2: Pool
85	86	R	Direction <ul style="list-style-type: none"> 1: Room 2: Tank
86	87	R	Outdoor type <ul style="list-style-type: none"> 1: STD 2: TCAP 3: HWT

⁵ See section 7 for possible error codes and their explanation

4.2.7 Device registers

Register Address (protocol address)	Register Address (PLC address)	R/W	Description
49	50	R	Device ID: 0x0D00
50	51	R	Software version

4.2.8 Considerations on Temperature Registers

Setpoint temperature may be controlled from 4 different internal parameters of the Hydro Unit: *Water shift, Water, Room and Pool*.

All these parameters depend on the configuration of the *Zone setup, Zone temp. setting mode and Operation Mode*.

Find below the correspondence of this configuration to know which internal parameter is modified when we are controlling registers 12 and 13 (Modbus Protocol Address), corresponding to **Zone 1 setpoint temperature** and **Zone 2 setpoint temperature** respectively.

Zone x setup	Zone x temp. set. mode	Operation Mode	Zone x set. temp.	Zone x current temp
Zone1 (Prot Add 83)	Zone1 (Prot Add 16)	(Prot Addr 4)	Zone1 (Prot Add 12)	Zone 1 (Prot Add 14)
Zone2 (Prot Add 84)	Zone2 (Prot Add 17)		Zone2 (Prot Add 13)	Zone 2 (Prot Add 15)
1: Room	1: Room temperature	1: Heat	Room	Room
	2: Compensation Curve	2: Heat Tank	Water Shift	Water
	3: Direct	3: Tank 4: Cool Tank 5: Cool	Water	
2: Pool	4: Pool Temp	1: Heat 2: Heat Tank	Pool	Pool

Notice that temperature's values temperature registers are expressed according to the temperature's format configured through its onboard DIP-Switches (See "4.3 - DIP-switch Configuration Interface"). These following formats are possible:

- **Celsius value:** Value in Modbus register is the temperature value in Celsius (i.e. a value "22" in the Modbus register must be interpreted as 22°C)
- **Decicelsius value:** Value in Modbus register is the temperature value in decicelsius (i.e. a value "220" in the Modbus register must be interpreted as 22.0°C)
- **Fahrenheit value:** Value in Modbus register is the temperature value in Fahrenheit (i.e. a value "72" in the Modbus register must be interpreted as 72°F (~22°C)).

4.2.9 Zones

Aquarea H/J Generation includes the possibility to control up to 2 different zones. The register 82 (Modbus protocol address) indicates the number of zones configured in the Hydro unit: 1 or 2 zones.

Taking this information into account and only in case that Hydro unit is controlling 2 zones, the register address 9 (Modbus protocol address) can be used to switch on/off the zones. Notice that if the Hydro unit is configured to manage a single zone, the use of the register address 9 (Modbus protocol address) doesn't have any effect.

Please, check the Hydro Unit User's Manual for more information about the zones' configuration and their options.

4.3 DIP-switch Configuration Interface

All the configuration values on INMBSPAN001A000 can be written and read from Modbus interface. Otherwise, some of them can also be setup from its on-board DIP-switch interface. The device has DIP-switches SW1, SW3 and SW4 on the following locations:

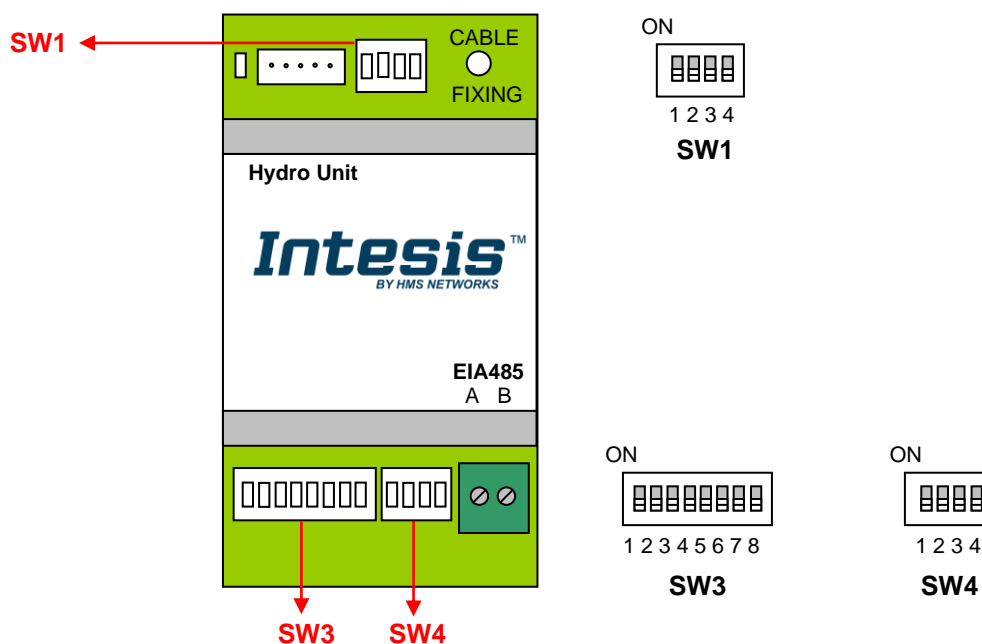

The following tables apply to the interface's configuration through DIP-switches:

SW1– Hydro unit's features

SW1-P1..4	Description
	Set point limits are defined by the configuration of Aquarea H/J Generation Unit (Default value).
	Set point limits are the maximum ones allowed by the manufacturer, not considering the specific Aquarea H/J Generation Unit's limits
	Reserved, not used (Default value)
	Reserved, not used





	Reserved, not used (Default value)
	Reserved, not used
	Reserved, not used (Default value)
	Reserved, not used

Table 4.1 SW1: Hydro unit's features

SW3/SW4 – Baud rate configuration













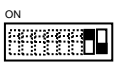



SW3-P7..8	SW4-P3	Description
		2400bps
		4800bps
		9600bps (Default value)
		19200bps
		38400bps
		57600bps
		76800bps
		115200bps

Table 4.2 SW3-SW4: Modbus baud rate

SW4 – Degrees/Decidegrees (x10), temperature magnitude (°C/°F) and EIA-485 termination resistor.



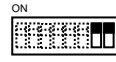



SW4-P1..2-4	Description
	Temperature values in Modbus register are represented in degrees (x1) (Default value)
	Temperature values in Modbus register are represented in decidegrees (x10)
	Temperature values in Modbus register are represented in Celsius degrees (Default value)
	Temperature values in Modbus register are represented in Fahrenheit degrees
	EIA-485 bus without termination resistor (Default value)
	Internal termination resistor of 120Ω connected to EIA-485 bus

Table 4.3 SW4: Temperature and termination resistor configuration

SW3 – Modbus Slave address

Add	SW3-P1..6	Add	SW3-P1..6	Add	SW3-P1..6	Add	SW3-P1..6	Add	SW3-P1..6
0		13		26		39		52	
1		14		27		40		53	
2		15		28		41		54	
3		16		29		42		55	
4		17		30		43		56	
5		18		31		44		57	
6		19		32		45		58	
7		20		33		46		59	
8		21		34		47		60	
9		22		35		48		61	
10		23		36		49		62	
11		24		37		50		63	
12		25		38		51			

Table 4.4 SW3: Modbus slave address

4.4 Implemented Functions

INMBSPAN001A000 implements the following standard Modbus functions:

- *3: Read Holding Registers*
- *4: Read Input Registers*
- *6: Write Single Register*
- *16: Write Multiple Registers* (Despite this function is allowed, the interface does not allow to write operations on more than 1 register with the same request, this means that length field should be always be 1 when this function is being used in case of writing)

4.5 Device LED indicator

The device includes two LED indicators to show all the possible operational states. In the following table there are written the indicators which can be performed and their meaning.

L1 (yellow LED)

Device status	LED indication	ON / OFF Period	Description
During not normal operation	LED blinking	500ms ON / 500ms OFF	Communication error
During normal operation	LED flashing	100ms ON / 1900ms OFF	Normal operation (configured and working properly)

L1 (green LED) & L2 (red LED)

Device status	LED indication	ON / OFF Period	Description
During normal operation	LED Pulse	5sec ON / --- OFF	Device Start-up
During not normal operation	LED alternatively blinking	500ms ON / 500ms OFF	EEPROM failure

4.6 EIA-485 bus. Termination resistors and Fail-Safe Biasing mechanism

EIA-485 bus requires a 120Ω terminator resistor at each end of the bus to avoid signal reflections.

In order to prevent fail status detected by the receivers, which are "*listening*" the bus, when all the transmitters' outputs are in three-state (high impedance), it is also required a fail-safe biasing mechanism. This mechanism provides a safe status (a correct voltage level) in the bus when all the transmitters' outputs are in three-state. This mechanism must be supplied by the Modbus Master.

The INMBSPAN001A000 device includes an on-board terminator resistor of 120Ω that can be connected to the EIA-485 bus by using DIP-switch SW4.

Some Modbus RTU EIA-485 Master devices can provide also internal 120Ω terminator resistor and/or fail-safe biasing mechanism (Check the technical documentation of the Master device connected to the EIA-485 network in each case).

5. Electrical and Mechanical features

Enclosure	Plastic, type PC (UL 94 V-0) Net dimensions (dxwxh): 93 x 53 x 58 mm / 3.7" x 2.1" x 2.3" Color: Light Grey. RAL 7035	Operation Temperature	0°C to +60°C
Weight	85 g.	Stock Temperature	-20°C to +85°C
Mounting	Wall DIN rail EN60715 TH35.	Operational Humidity	<95% RH, non-condensing
Terminal Wiring (for low-voltage signals)	For terminal: solid wires or stranded wires (twisted or with ferrule) 1 core: 0.5mm²... 2.5mm² 2 cores: 0.5mm²... 1.5mm² 3 cores: not permitted	Stock Humidity	<95% RH, non-condensing
Modbus RTU port	1 x Serial EIA485 Plug-in screw terminal block (2 poles): A, B Compatible with Modbus RTU EIA-485 networks	Isolation voltage	1500 VDC
Hydro unit port	1 x Specific connector Specific cable included	Isolation resistance	1000 MΩ
Switch 1 (SW1)	1 x DIP-Switch for Hydro Unit features	Protection	IP20 (IEC60529)
Switch 3 (SW3)	1 x DIP-Switch for Modbus RTU settings	LED indicators	1 x Onboard LED - Operational status
Switch 4 (SW4)	1 x DIP-Switch for extra functions		

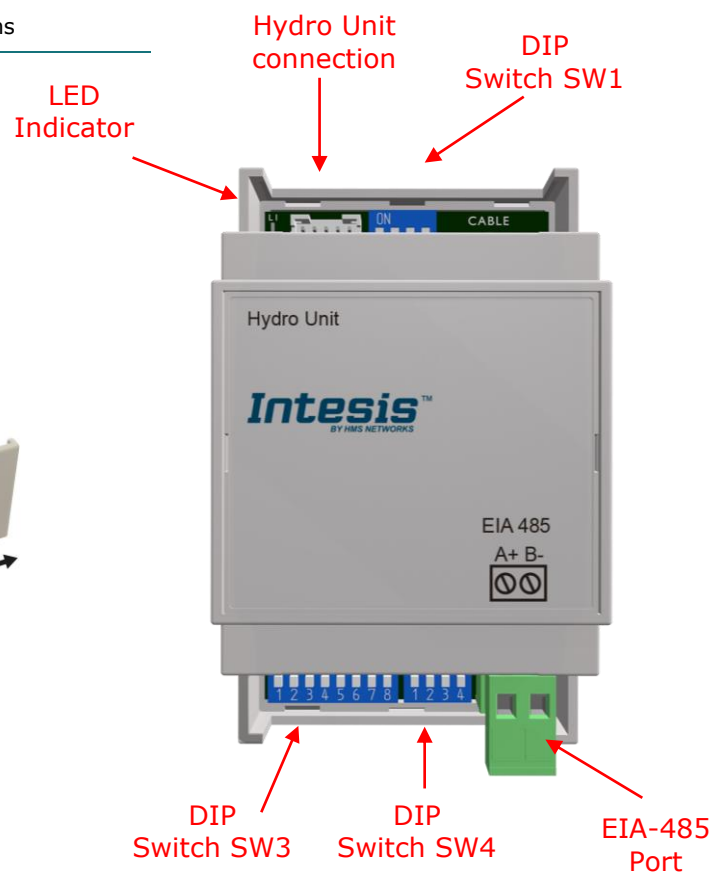
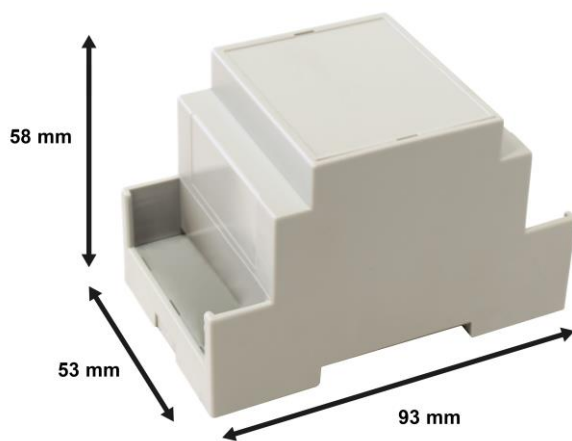

6. List of supported Hydro Unit Types.

A list of Panasonic Hydro unit model's references compatible with INMBSPAN001A000 and their available features can be found in:

https://www.intesis.com/docs/compatibilities/inxxxpan001a000_compatibility

7. Error Codes

Error Code Modbus	Error in Remote Controller	Error Description
0	H00	No abnormality detected
112	H12	Indoor/Outdoor capacity unmatched
115	H15	Outdoor compressor temperature sensor abnormality
120	H20	Water pump abnormality
123	H23	Indoor refrigerant liquid temperature sensor abnormality
127	H27	Service valve error
128	H28	Abnormal solar sensor
131	H31	Abnormal swimming pool sensor
136	H36	Abnormal buffer tank sensor
138	H38	Brand code not match
142	H42	Compressor low pressure abnormality
143	H43	Abnormal Zone 1 sensor
144	H44	Abnormal Zone 2 sensor
162	H62	Water flow switch abnormality
163	H63	Refrigerant low pressure abnormality
164	H64	Refrigerant high pressure abnormality
165	H65	Deice circulation error
167	H67	Abnormal External Thermistor 1
168	H68	Abnormal External Thermistor 2
170	H70	Back-up heater OLP abnormality
172	H72	Tank sensor abnormal
174	H74	PCB communication error
175	H75	Low water temperature control
176	H76	Indoor - control panel communication abnormality
190	H90	Indoor/outdoor abnormal communication
191	H91	Tank heater OLP abnormality
195	H95	Indoor/Outdoor wrong connection
198	H98	Outdoor high pressure overload protection
199	H99	Indoor heat exchanger freeze prevention
212	F12	Pressure switch activate
214	F14	Outdoor compressor abnormal revolution
215	F15	Outdoor fan motor lock abnormality
216	F16	Total running current protection
220	F20	Outdoor compressor overheating protection
222	F22	IPM (power transistor) overheating protection
223	F23	Outdoor Direct Current (DC) peak detection
224	F24	Refrigeration cycle abnormality
225	F25	Cooling/Heating cycle changeover abnormality
227	F27	Pressure switch abnormality
229	F29	Low Discharge Superheat
230	F30	Water outlet sensor 2 abnormality
232	F32	Abnormal Internal Thermostat
236	F36	Outdoor air temperature sensor abnormality
237	F37	Indoor water inlet temperature sensor abnormality
240	F40	Outdoor discharge pipe temperature sensor abnormality
241	F41	PFC control
242	F42	Outdoor heat exchanger temperature sensor abnormality
243	F43	Outdoor defrost sensor abnormality
245	F45	Indoor water outlet temperature sensor abnormality
246	F46	Outdoor Current Transformer open circuit
248	F48	Outdoor EVA outlet temperature sensor abnormality

Error Code Modbus	Error in Remote Controller	Error Description
249	F49	Outdoor bypass outlet temperature sensor abnormality
295	F95	Cooling high pressure overload protection

In case to detect an error code not listed, contact your closest Panasonic technical support service.