

CE!



EL.MO.

GLOBAL SECURITY SOLUTIONS

**LUPUS and VOLANS models
advanced wireless transmitters for
wireless intrusion detection systems**

TECHNICAL MANUAL

FOREWORD

FOR THE INSTALLER:

Please follow carefully the specifications relative to electric and security systems realization further to the manufacturer's prescriptions indicated in the manual provided.

Provide the user the necessary indication for use and system's limitations, specifying that there exist precise specifications and different safety performances levels that should be proportioned to the user needs. Have the user view the directions indicated in this document.

FOR THE USER:

Periodically check carefully the system functionality making sure all enabling and disabling operations were made correctly.

Have skilled personnel make the periodic system's maintenance. Contact the installer for verifying the correct system operation in case its conditions changed (e.g.: variations in the areas to protect due to extension, change of the access modes etc...)

.....
This device has been projected, assembled and tested with the maximum care, adopting control procedures in accordance with the laws in force. The full correspondence to the functional characteristics is given exclusively when it is used for the purpose it was projected for, which is as follows:

advanced wireless transmitters for wireless intrusion detection systems

Any use other than the one mentioned above has not been forecasted and therefore it is not possible to guarantee its correct operativeness.

The manufacturing process is carefully controlled in order to prevent defaults and bad functioning. Nevertheless, an extremely low percentage of the components used is subjected to faults just as any other electronic or meccanic product. As this item is meant to protect both property and people, we invite the user to proportion the level of protection that the system offers to the actual risk (also taking into account the possibility that the system was operated in a degraded manner because of faults and the like), as well reminding that there are precise laws for the design and assemblage of the systems destined to these kind of applications.

The system's operator is hereby advised to see regularly to the periodic maintenance of the system, at least in accordance with the provisions of current legislation, as well as to carry out checks on the correct running of said system on as regular a basis as the risk involved requires, with particular reference to the control unit, sensors, sounders, dialler(s) and any other device connected. The user must let the installer know how well the system seems to be operating, based on the results of periodic checks, without delay.

Design, installation and servicing of systems which include this product, should be made by skilled staff with the necessary knowledge to operate in safe conditions in order to prevent accidents. These systems' installation must be made in accordance with the laws in force. Some equipment's inner parts are connected to electric main and therefore electrocution may occur if servicing was made before switching off the main and emergency power.

Some products incorporate rechargeable or non rechargeable batteries as emergency power supply. Their wrong connection may damage the product, properties and the operator's safety (burst and fire).

YOUR DEALER:

1. GENERAL INFORMATION

The transmitters covered herein are used to control windows, doors or perimeter fences managed by wireless systems employing the HELIOS control unit, or other compatible models such as URANUS, as the processing unit. Generally speaking, they have the following features:

LUPUS = Used to transmit changes of state of magnetic contacts or of a detector for rolling shutters hard-wired to its terminals. Different transmission codes are used so that you can promptly tell which input the alarm was sent from. It features two glass tubes with a reed contact, one for each side of the housing, to make positioning easier. The built-in reed contact can be selected and used instead of the input on the terminal strip.

The input for the rolling shutter is suitably programmed to be connected to an additional magnetic sensor for use in homes with shutters and windows.

VOLANS = Used to transmit changes of state of magnetic contacts or of a detector for rolling shutters hard-wired to its terminals. Different transmission codes are used so that you can promptly tell which input the alarm was sent from. It features two glass tubes with a reed contact, one for each side of the housing, to make positioning easier. The built-in reed contact can be selected and used instead of the input on the terminal strip. It features a piezo knock sensor with adjustable sensitivity built into the plastic base to be used instead of or in conjunction with the detector for rolling shutters.

The plastic housing features a brand-new design in line with current style trends.

To identify the remote device, a digital code is sent at a frequency prescribed for low-power devices (LPD). The code is generated during the device's installation - random digital encoding actually selects a valid code from a possible 34 billion combinations. An anticollision procedure is activated for incoming signals to increase system security.

Transmitters also send battery low and tampering state signals (when housing is opened) and signals for supervision with adjustable times.

The range of said devices is calculated based on a free field with no obstacles. Nonetheless, in some applications indoors where the building's structure features particular restraints, range may be reduced in the case of LUPUS, and for VOLANS range is 80 metres. The radio signal is encoded and sent to control units - **HELIOS models and other compatible devices only**. The transmitters' battery runtime is expressed in terms of years of service, depending on the individual model's specifications.

2. SPECIFICATIONS

Model:	LUPUS	VOLANS
IP rating:	IP3X	
Supply voltage:	Powered with standard 9V alkaline battery type 6LR61	
Battery low threshold:	6V, regular condition restored at 6.5V	
Minimum operating voltage:	4,5V	
Current demand @9V:	11 µA on standby, maximum 23 mA.	20 µA on standby, maximum 23 mA.
TX frequency:	Digital transmissions over frequencies for LPDs (Low-Power Devices).	
Connection range:	80 metres in free field subject to limitations imposed by environmental conditions.	
Average battery runtime:	4 years with 6LR61 batteries (2 complete transmissions, opening and closing per day), 3 years with 6LR61 batteries (20 complete transmissions, opening and closing per day).	
	Note: The low battery signal is generated when the transmitter's battery runtime reaches 2/3.	
Inputs:	NC input for magnetic contacts. NC input comes with default setting for connection with detectors for rolling shutters; can be reprogrammed, where necessary, for another input for magnetic contacts - consult the chapter entitled "SETUP AND CODE GENERATION PROCEDURES" on page 15.	NC input for magnetic contacts. NC input for connection with detectors for rolling shutters. It can also be used in conjunction with the built-in piezo sensor.
Special operation features:		Piezo sensor built into the base with impact sensitivity adjustment and LED indicating pulses detected.
Cable run with 2 x 0.22 mm ² cable:	Input for rolling shutters limited to total run of 1 metre; max. 100 metres for input for magnetic contacts.	
Adjustments:		Trimmer adjustment for impact sensitivity. Alarm after 2 pulses detected in 15 sec. Detection of frequencies below 1Hz.
Settings:	The input for rolling shutters features a factory-set sensitivity of 8 pulses in 8 sec.	
Selections:	Selection jumpers for setting Supervision time, enabling on-board magnetic reed contact (one each side), enabling supervision.	
Indicators:	Green LED on front.	Yellow LED on front. Red LED inside for pulses from piezo sensor.

Model:	LUPUS	VOLANS
TX encoding:	Procedure for random code generating and storing in control unit's memory, see chapter.	
Rolling shutter input/ magnetic sensor setup:	Special procedure when first switched on, refer to chapter entitled "SETUP AND CODE GENERATION PROCEDURES" on page 15.	
Transmissions for:	Code for alarm from magnetic contact with reset transmission separate from transmission code of input for rolling shutter.	As other model but with the option of transmissions to report knocks detected by built-in piezo sensor.
Standard transmissions for:	Low battery state treated as code added to the end of the first effectual transmission. Periodic transmission for supervision settable with jumpers in the range 1.5 hours to 24 hours, with option of disabling with jumper. Tampering reporting when housing is opened.	
Operating temperature range:	-10 / +45 °C - 93 % rH.	
Dimensions:	Transmitter L 150 x H 33 x W 39 mm; magnet L 47 x H 18.5 x W 15 mm.	
Weight:	114 g (with battery and magnet). 115 g (with battery and magnet).	
Equipment:	Four §3.5 flat countersunk screws and screw anchors, 9V 6LR61 battery supplied with the kit, external magnet, technical manual.	

Transmitter models LUPUS and VOLANS for wireless systems are components of the wireless intrusion detection systems based on HELIOS and compatible control units. They conform to the following standards: CEI 79-16, CEI 79-2, ETSI 300-220, ETSI 301 489, R&TTE 1999/05/EC, EN 50130-4, EN 55022, EN 60950, 89/336/EEC, 73/23/EEC.

LUPUS and VOLANS transmitters are only suitable for installation inside the rooms to be protected. They must not be installed where they are likely to be affected by condensation, for instance fastened directly on a shutter.

3. MECHANICAL CHARACTERISTICS

View of the transmitter's plastic housing and external magnet

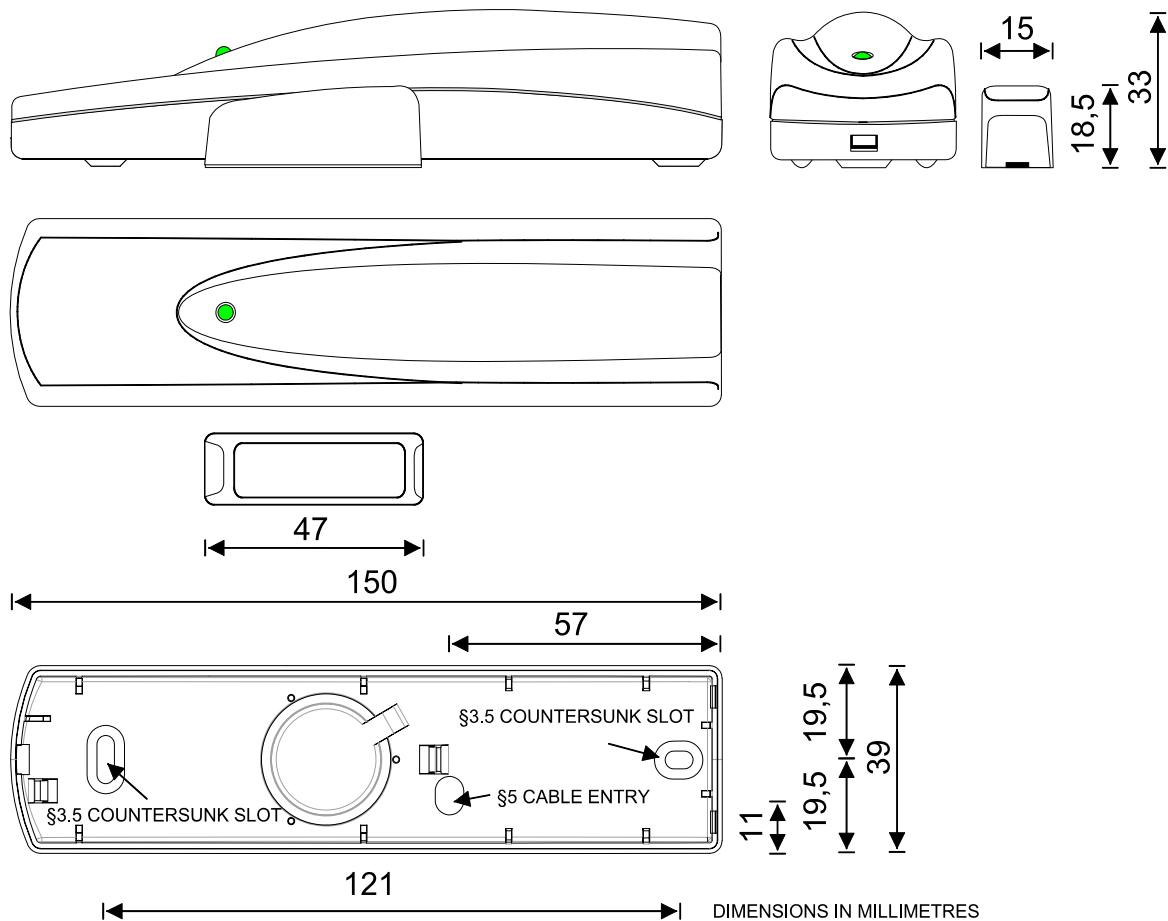

4. DISTINGUISHING PRODUCT FEATURES

You can easily tell the two transmitters apart by looking for the markings and features specified in the drawing below.

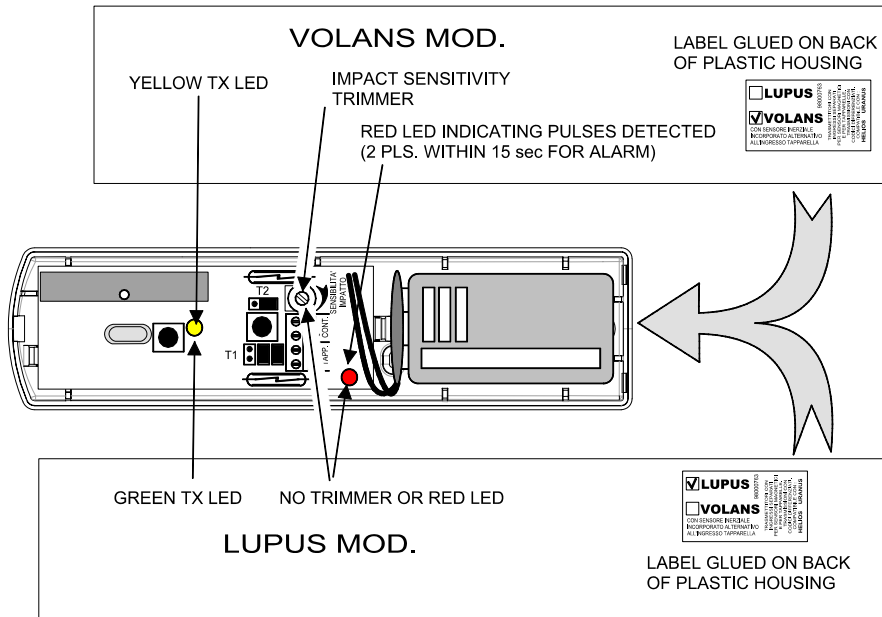

5. OPENING AND CLOSING THE HOUSING

Basic operations for opening and closing the transmitter's housing are illustrated below.

To open.

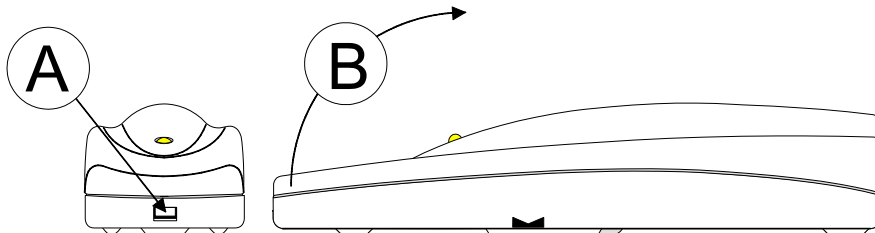

To close.

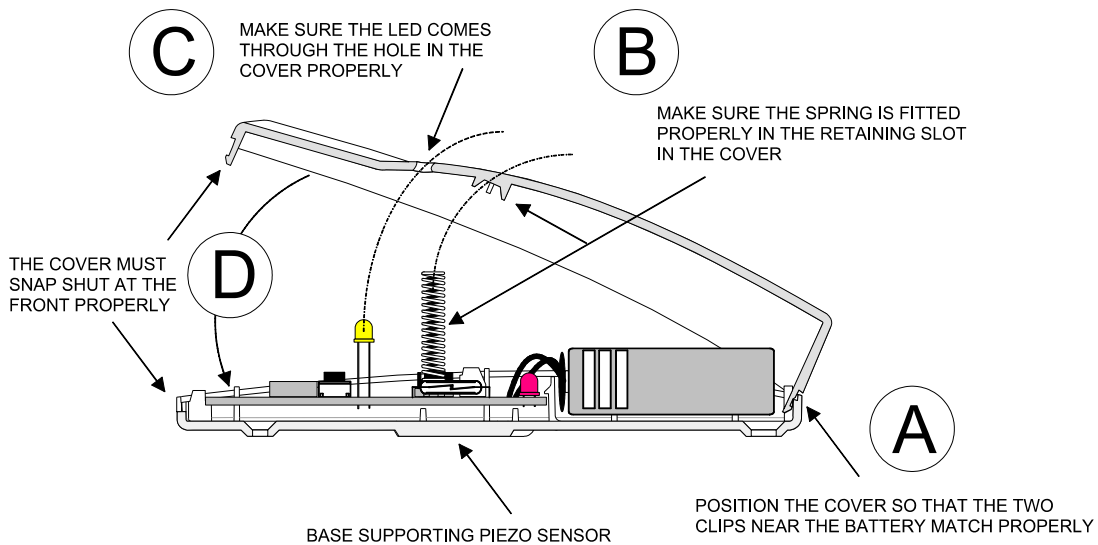

6. ELECTRICAL CONNECTIONS

View of transmitter's board, layout of jumpers and basic connections.

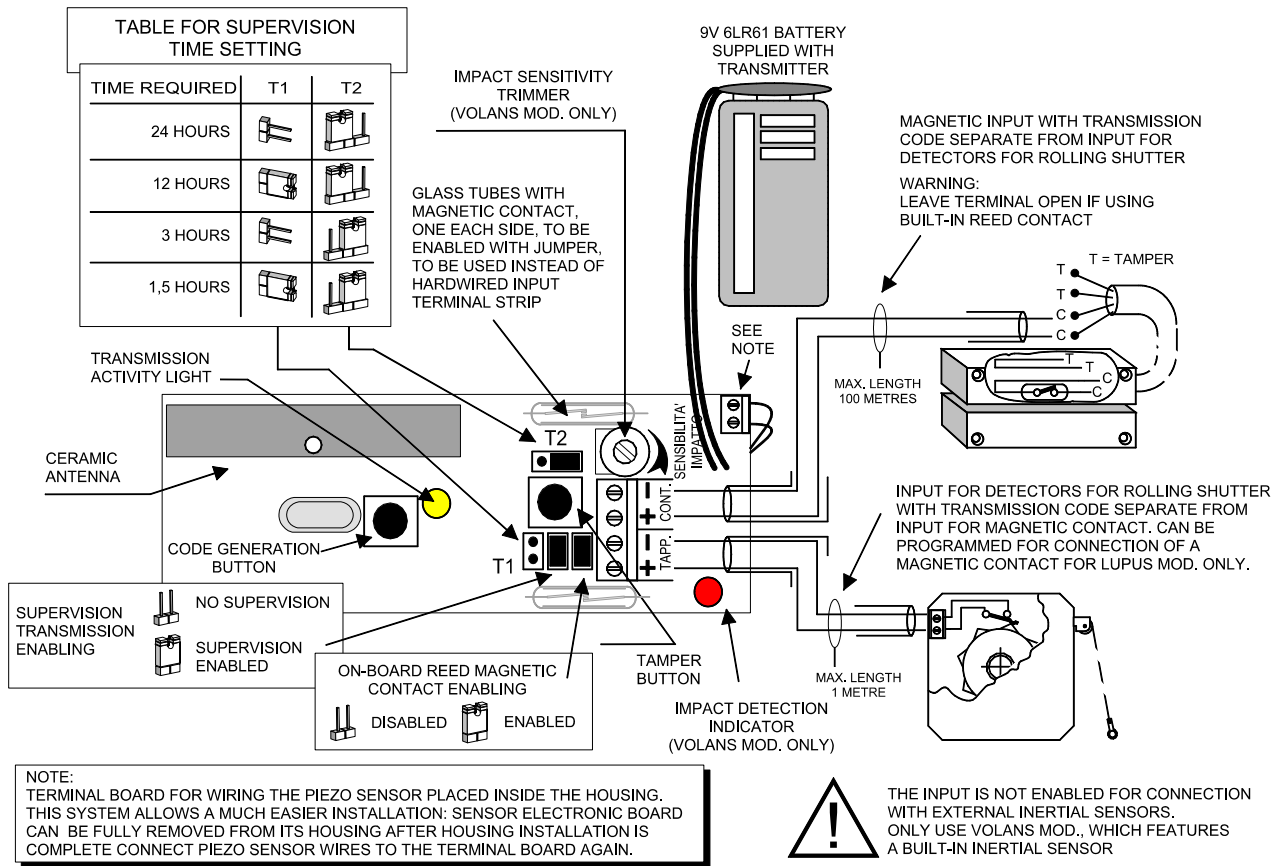

In transmitter mod. VOLANS, the piezo sensor is always on and cannot, therefore, be disabled. Where necessary, sensitivity can be reduced to a minimum using the trimmer by the side of the terminal strip.

6.1 Types of connection allowed for LUPUS model

On-board magnetic contact.

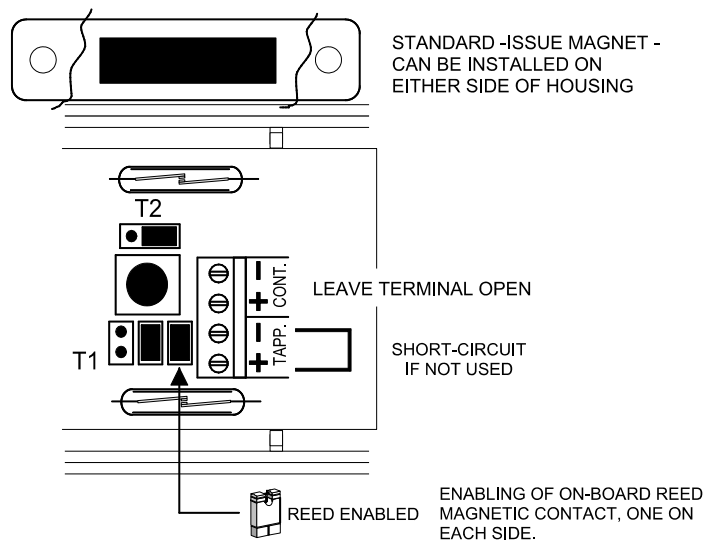

External magnetic contact.

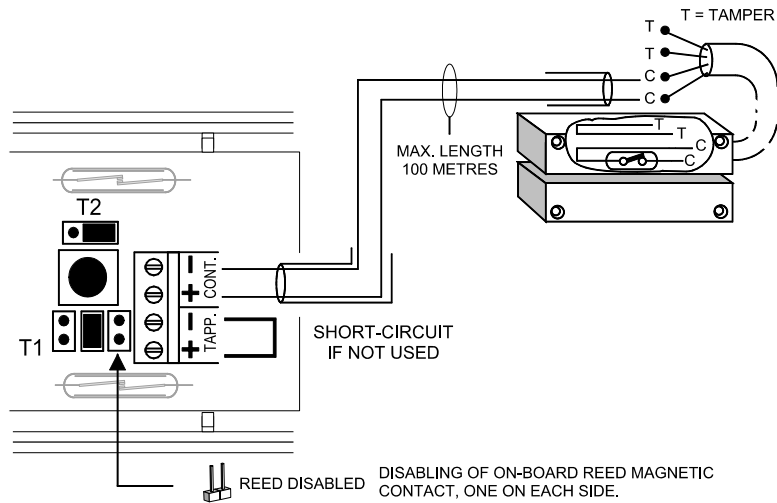

On-board and external magnetic contact.

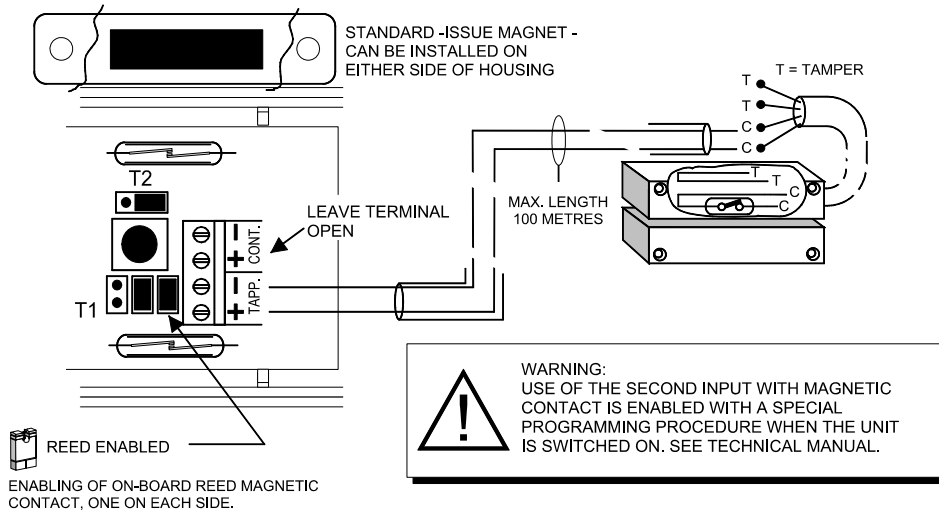

External magnetic contacts, use of two hardwired inputs.

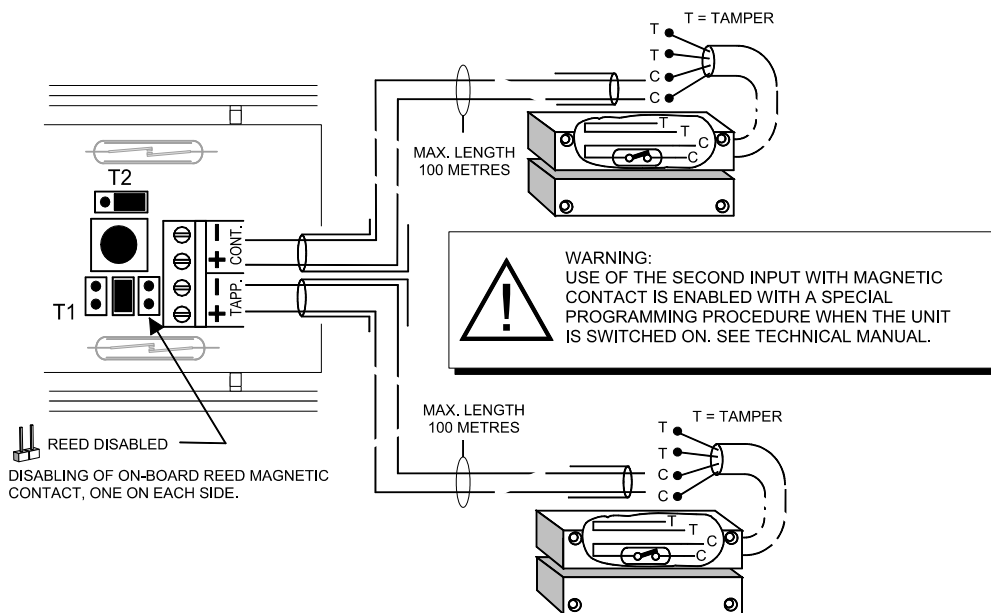

On-board magnetic contact and detector for rolling shutter.

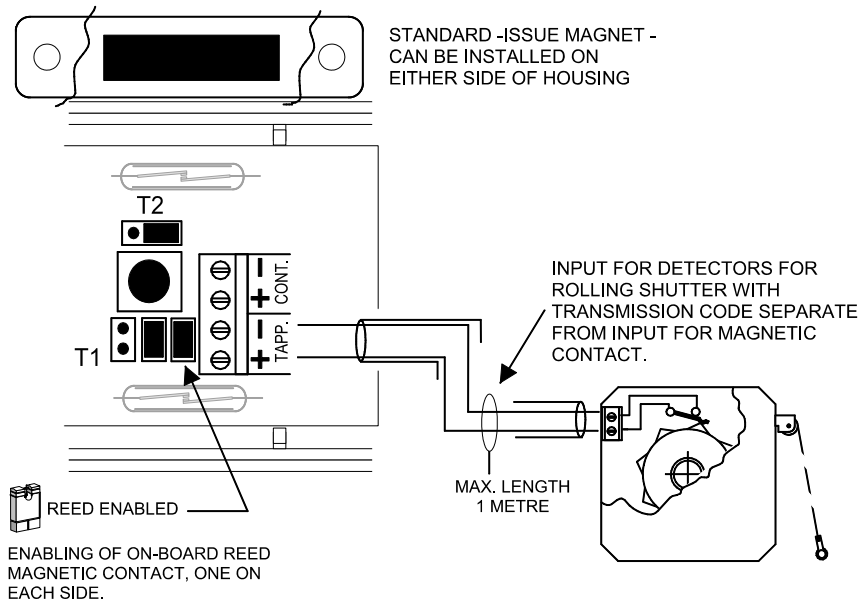

External magnetic contact and detector for rolling shutter.

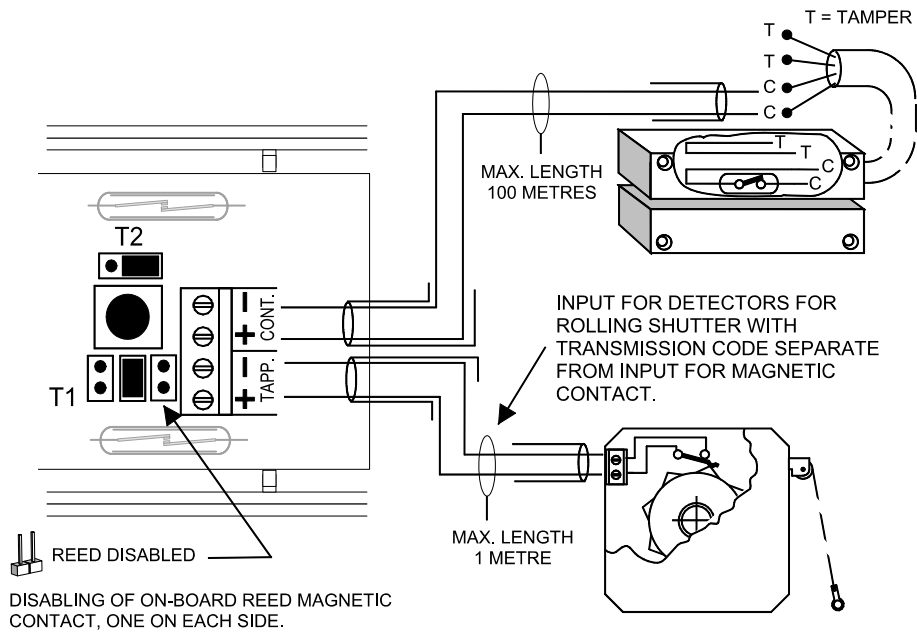

6.2 Types of connection allowed for VOLANS model

On-board magnetic contact and inertial sensor.

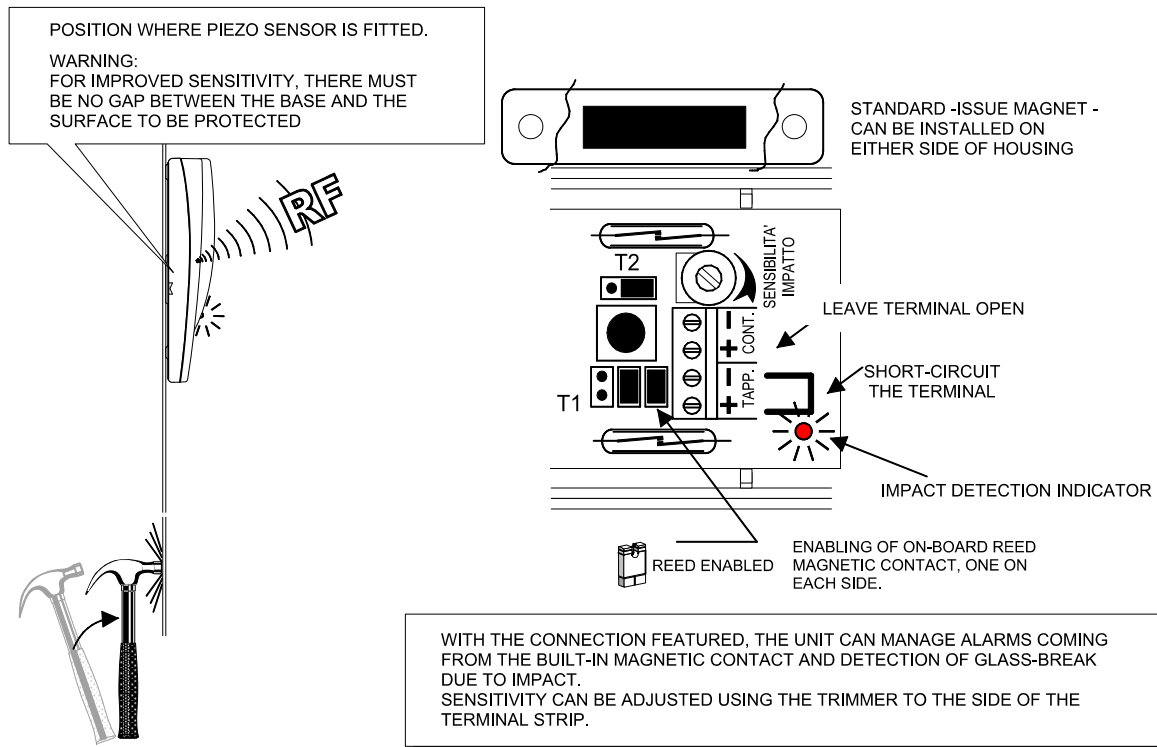

External magnetic contact and on-board inertial sensor.

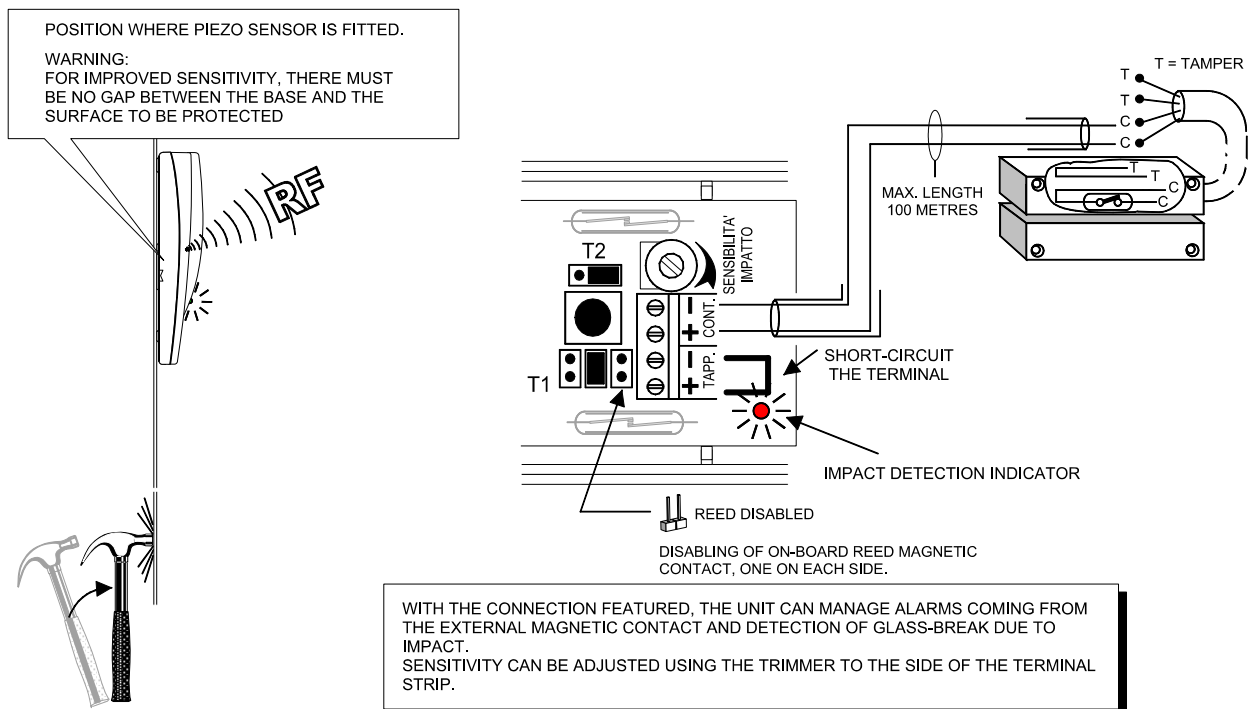

External magnetic contact, external detector for rolling shutter and on-board inertial sensor.

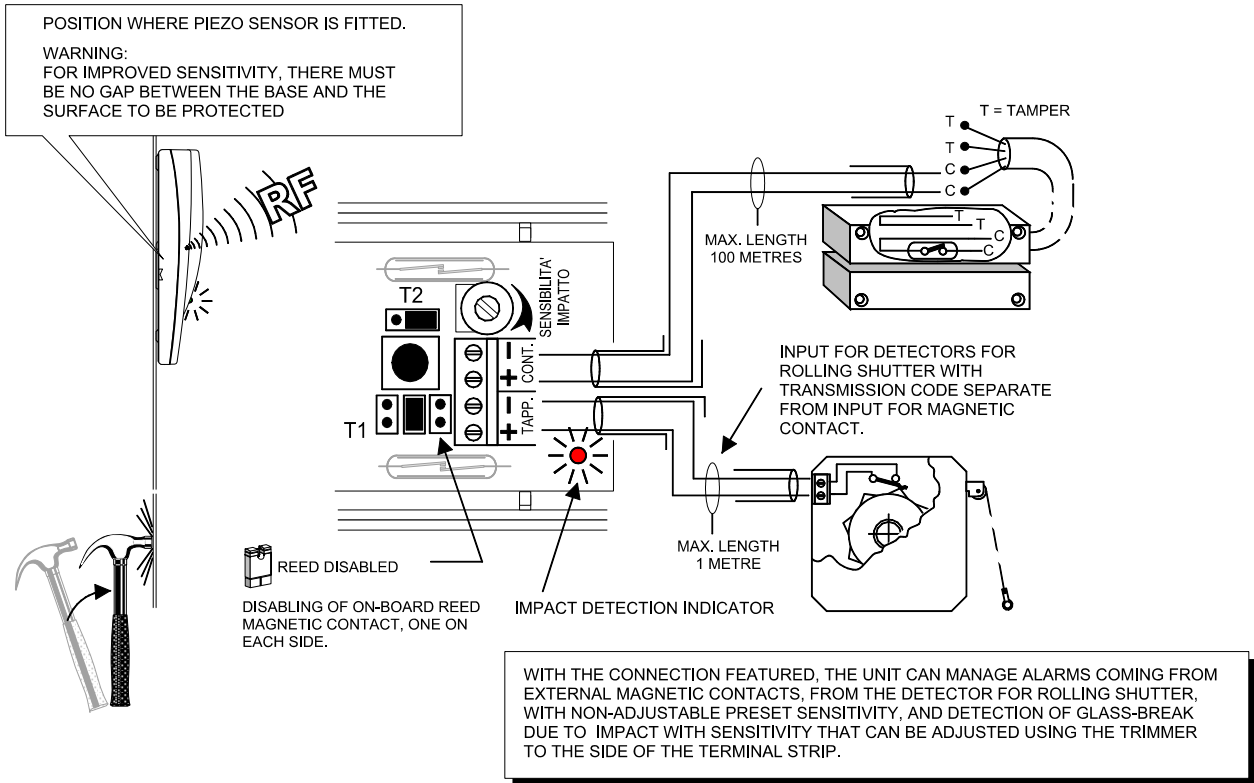

On-board inertial sensor only.

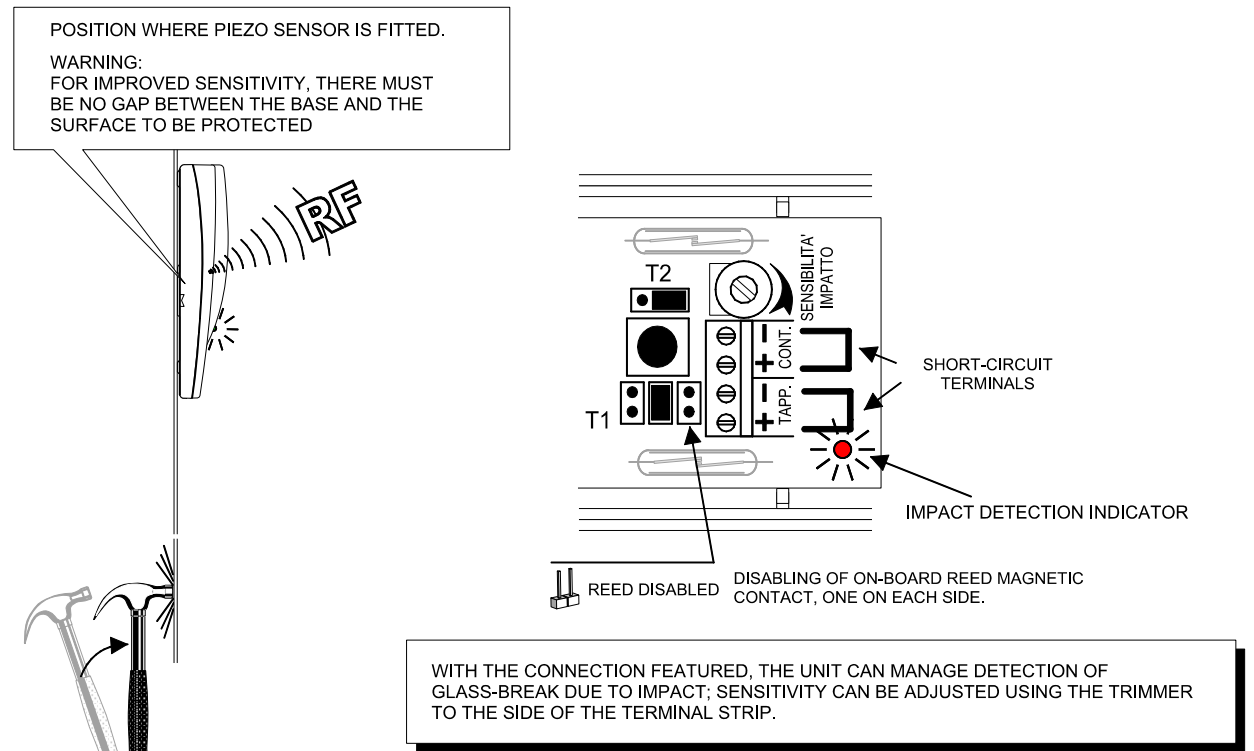

7. INSTALLATION

The transmitters must nonetheless be installed in conformity with a number of rules to avoid loss of performance as a result of positioning errors. It is vitally important, for instance, that you exercise extreme care when defining the receiving system's operating area within which the transmitter will be installed, as well as the detectors' actual coverage and correct installation, allowing in particular for the nature of the materials used for the building's construction. The following drawings illustrate right and wrong installation positions, what objects are likely to attenuate the RF signal, and how various building materials can cause attenuation.

Installation layouts.

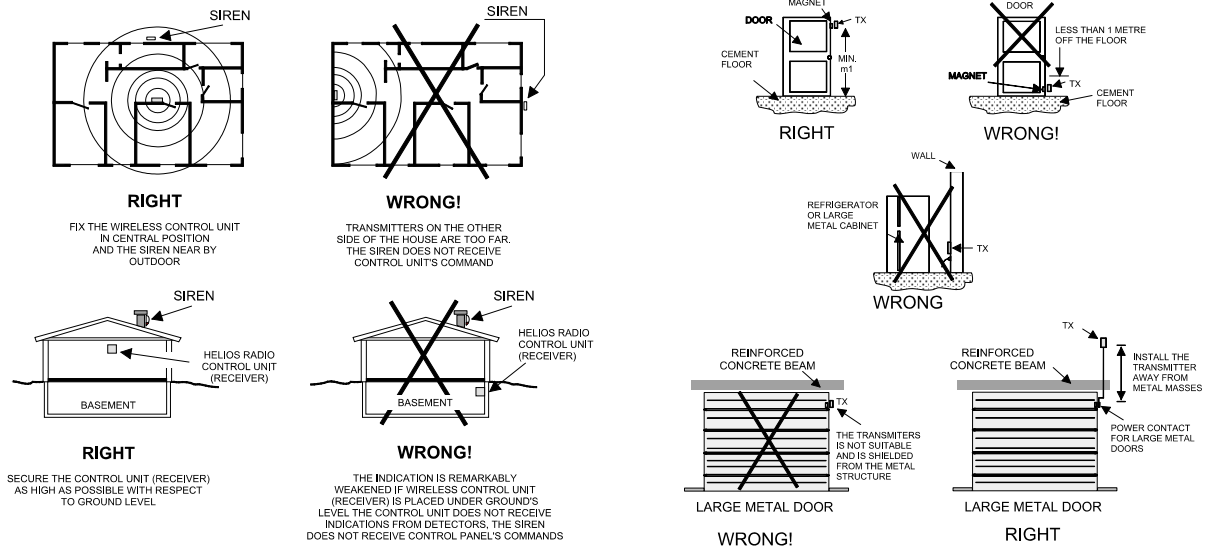

Radio signal attenuation by various common building materials.

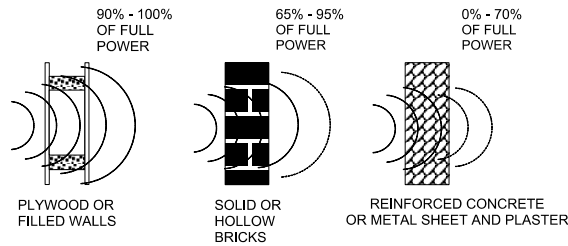

Objects likely to alter and/or decrease range.

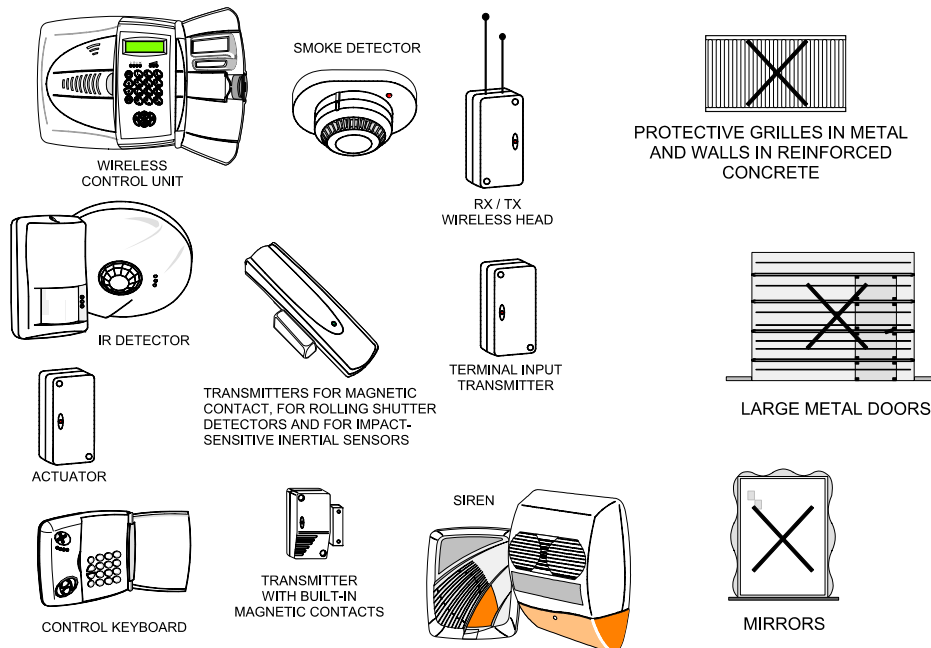

8. COVERAGE AND SENSITIVITY

Before proceeding to install the VOLANS detector, you will need to give the maximum sensitivity achievable some serious consideration based on the nature of the surface to be protected with its built-in piezo sensor.

The following table is provided for reference:

Surface	Brick wall	Steel	Wood	Concrete	Plywood	Glass *
Range in metres	1 metre	3 metres	3 metres	30 centimetres	3 metres	3 metres

* The test on glass was conducted by applying the detector with strong double-sided tape. For specific application on glass, the VOLANS transmitter is suitable for detecting impact but not cutting or drilling.

Application of VOLANS transmitter on a glass pane:

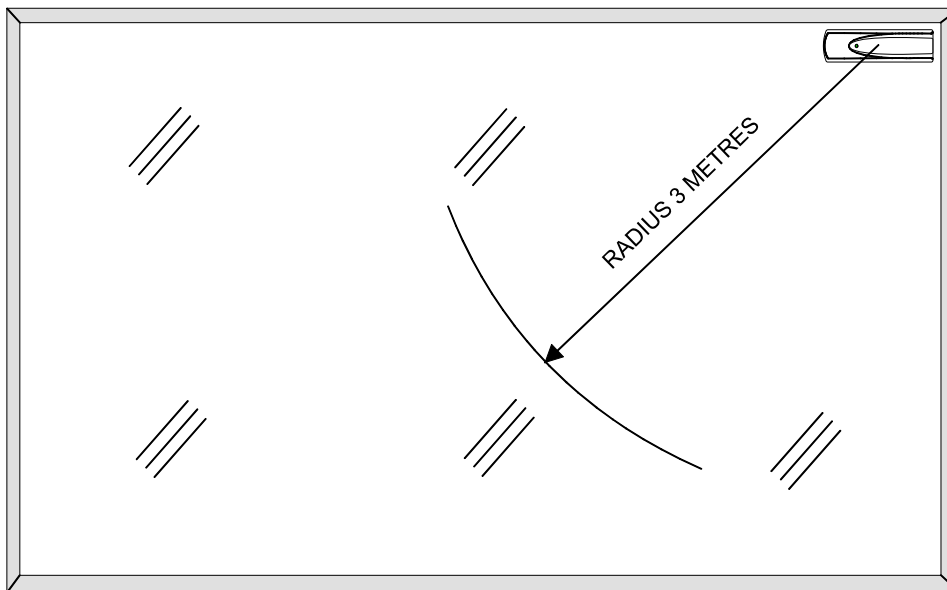

9. ASSEMBLY

Sample assembly of LUPUS transmitter inside rolling shutter box. The following figure shows which way round the unit should be fitted. To make changing the battery easier, the transmitter can also be installed on the outside edge of the box.

Make sure any additional bracket used to fasten the unit on is not metal, which is liable to result in a deteriorated radio signal emitted.

FASTENING POSITIONS

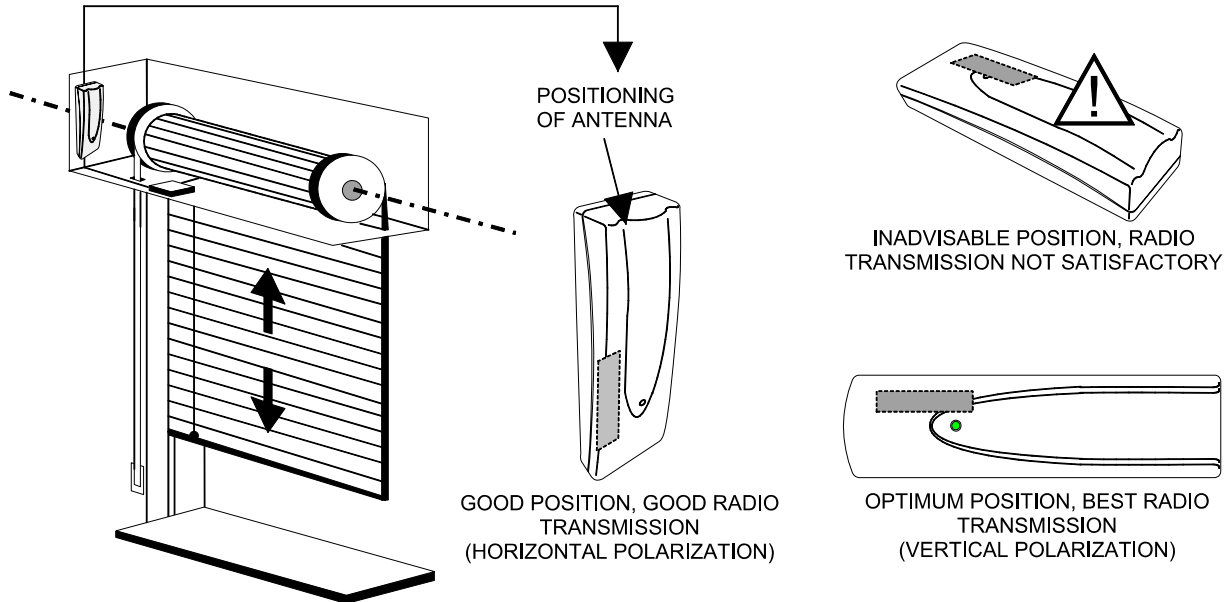

Sample general assembly, stage 1.

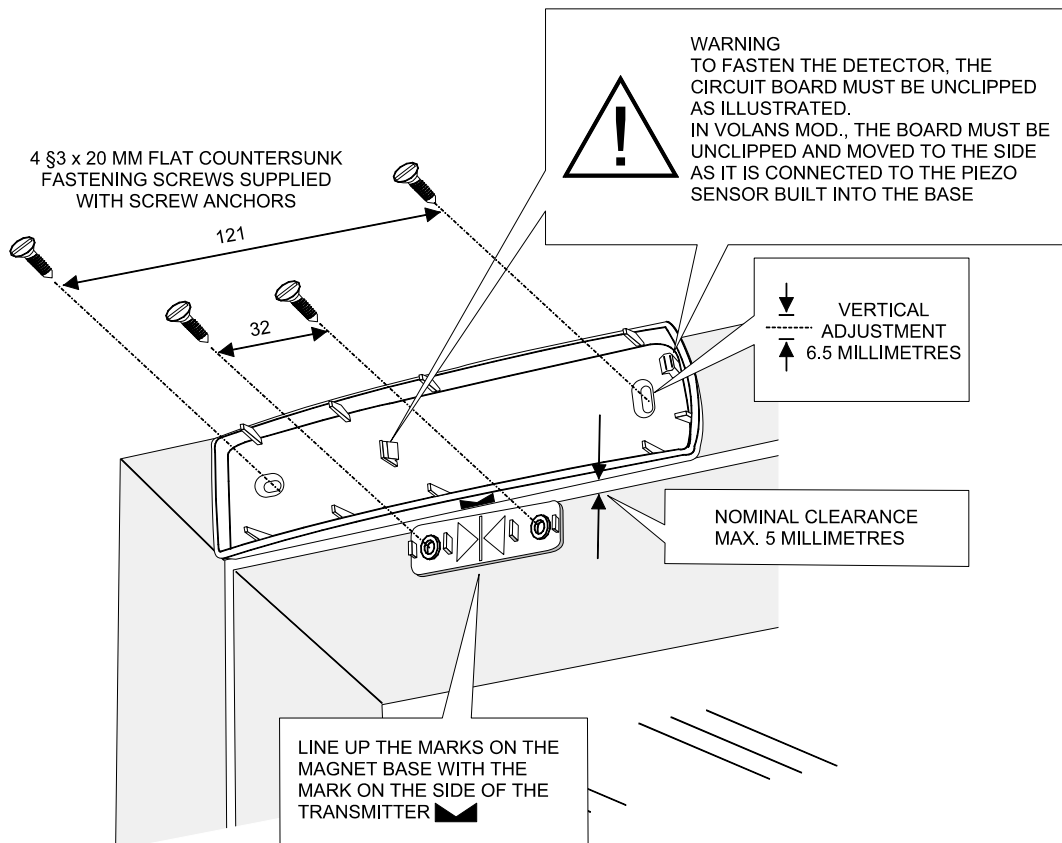

Sample general assembly, stage 2.

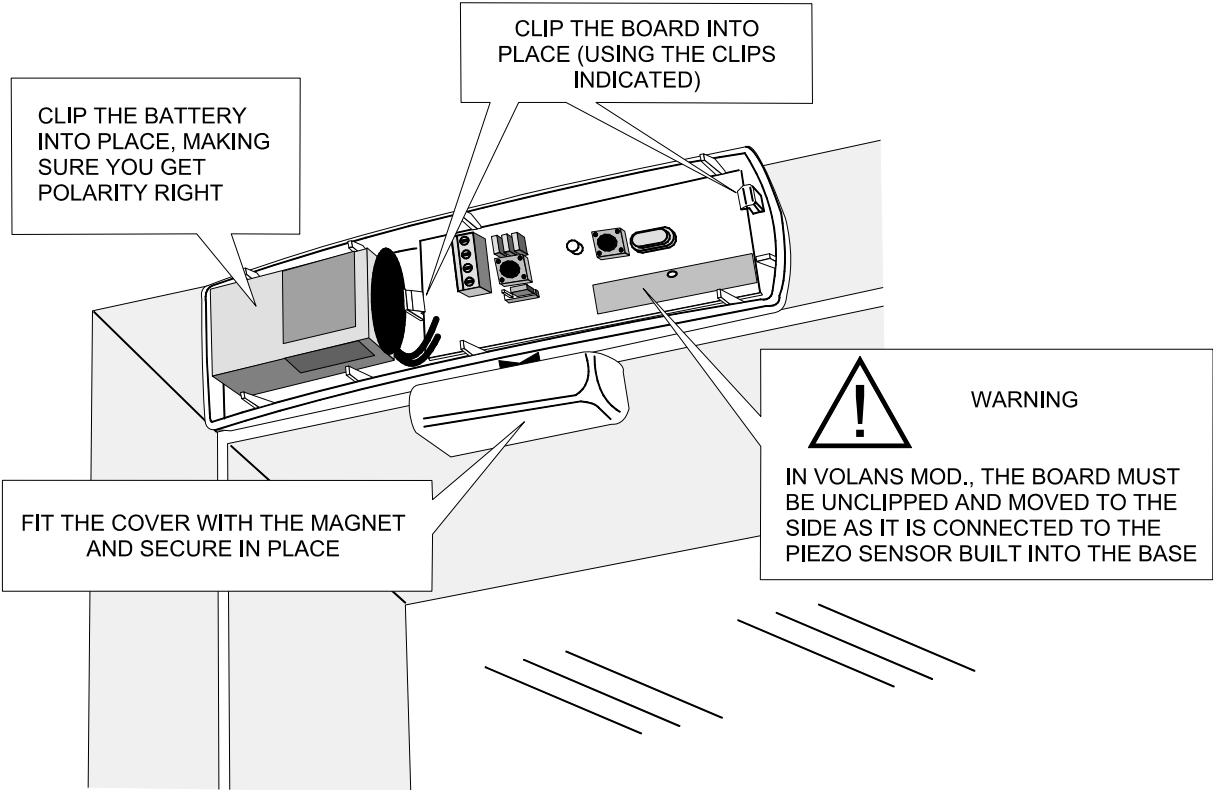

Sample general assembly, stage 3.

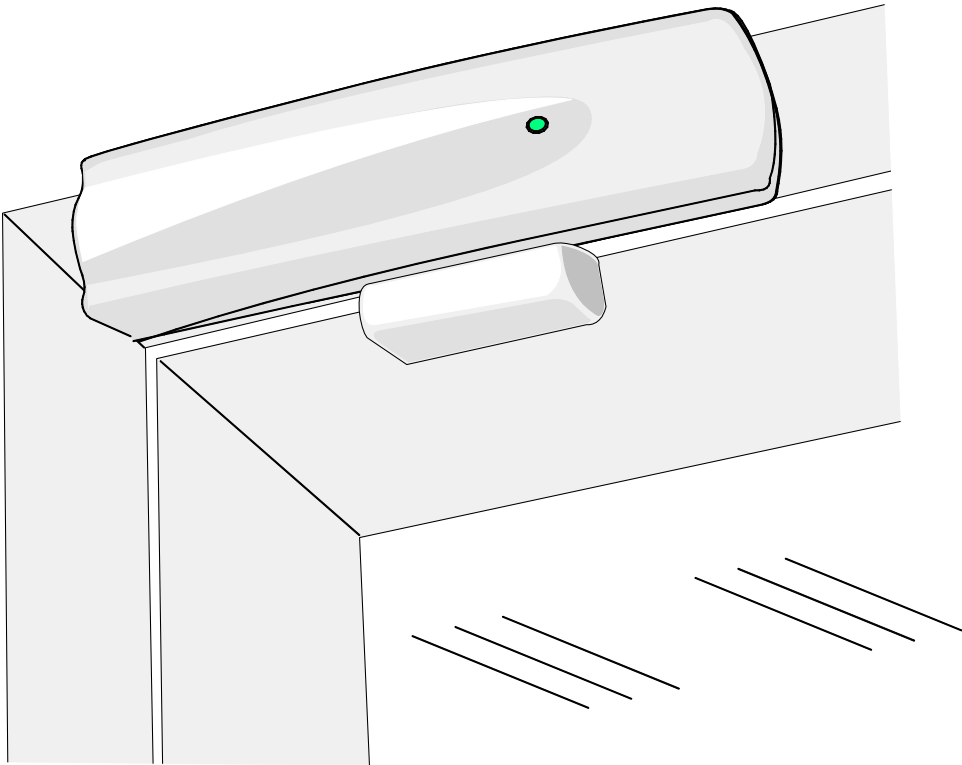

10. SETUP AND CODE GENERATION PROCEDURES

10.1 SETUP procedure

LUPUS and VOLANS feature a specialized input for connection with detectors for a rolling shutter, and relevant separate ID code. As specified earlier in the chapter on electrical connections, the cable run must not be longer than 1 metre.

Where necessary, **but only on LUPUS**, this input can be reprogrammed for connection with an additional magnetic contact, again with a separate ID code. Classic sample installations cater for protection of a window and a shutter or of two windows in the same room, or near each other at least.

To reprogramme the input, the device must be powered following the procedure below:

- Open the transmitter's plastic housing.
- Press the CODE GENERATION programming key in the middle and power the transmitter, holding the key down.
- During this procedure, watch the LED in the middle of the board, which will light. Depending on whether it is steadily lit or flashing, the corresponding operating mode will be:

STEADY-LIT LED	FLASHING LED
Operation of input for rolling shutter as input for secondary magnetic contact.	Operation of input for rolling shutter as input for rolling shutter .

- Release the key.
- To change the current selection, press the CODE GENERATION key until the LED changes state (from flashing to steady-lit or vice versa) and release the key.
- To save the resulting selection, switch off the power for more than 5 sec and switch it back on.
- If you stay in programming mode, the transmitter exits automatically after about 1 minute, saving the last operating mode programmed.
- **You can only commence code self-generation once the SETUP procedure is finished.**

10.2 Code self-generation and storing procedures

- Check whether the LUPUS transmitter's SETUP operation has been performed and install the unit as indicated herein.
- Wire as appropriate.
- Clip the specific battery into place, making sure you get polarity right.

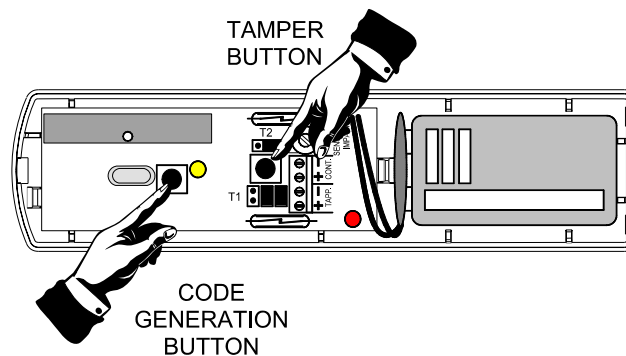

- Press the "CODE GENERATION" button and hold it down.
- Hold the Tamper button down for at least one second and release.
- Hold the "CODE GENERATION" button down for another three seconds until the transmission light flashes on and off quickly, at which point you can release the button.
- Enter control unit programming by keying in the user code and pressing "#", select the "SYSTEM PROGRAMMING" menu, "OK", "↑".
At this point, you can select one of two programming methods: "TOTAL PROGRAMMING" if you are enabling the whole system or "PROGRAMMING EDITING" if you want to add a transmitter to the existing ones.
Press "OK" to call up the menu. Follow the instructions that come up on the display.
The example refers to a HELIOS control unit.

H. Press the TAMPER button and hold it down. This sends the ID code of the magnetic sensor wired to the transmitter's terminal or of the on-board magnetic contact if previously enabled with the jumper.

NOTE: If you are only interested in control with the magnetic sensor and not with the detector for rolling shutters, exit programming now and ONLY release the TAMPER button once you have exited.

WARNING: If you get the TAMPER button pressing sequence wrong and press and release by mistake, the transmitter's code is stored incorrectly and it is essential you delete the last transmitters stored and repeat the procedure correctly.

I. With the TAMPER button still held down, continue through the control unit's menu to add a new transmitter. Activate recognition of the new transmitter.

J. Release the TAMPER button. The control unit recognizes the code received as coming from the rolling shutter detector matching the code of the piezo inertial sensor when the VOLANS transmitter is used. Exit programming in the usual manner.

NOTE: When using the transmitter programmed for the additional magnetic input, the code of the additional input for the magnetic contact is sent to the control unit when the TAMPER button is released.

K. Once the separate codes - for the magnetic input and detector for rolling shutters - have been stored, you can start specific programming of the attributes. For this stage, we recommend you follow the programming steps given in the control unit's manual.

L. Install the transmitter in one of the permitted positions - refer to the drawings in the manual to get this part right - and make a few trial transmissions to ensure it is working properly.

11. DISPOSAL CONSIDERATIONS

LUPUS and VOLANS must be disposed of in accordance with local municipal provisions in force, and handed in to an authorized facility for the disposal of electronic equipment. Where necessary, seek the advice of the local authority's waste management department.

Warnings concerning disposal of batteries

The products in question must each be connected to a 6LR61 battery to work properly. You must ensure, when replacing this battery with an identical model, that the used battery is handed in to an authorized facility for battery disposal.

The material used is very harmful and pollutant if released to the environment

12. CONTENTS

1. GENERAL INFORMATION	3
2. SPECIFICATIONS	3
3. MECHANICAL CHARACTERISTICS	4
4. DISTINGUISHING PRODUCT FEATURES	5
5. OPENING AND CLOSING THE HOUSING	5
6. ELECTRICAL CONNECTIONS	6
6.1. Types of connection allowed for LUPUS model	6
6.2. Types of connection allowed for VOLANS model	9
7. INSTALLATION	11
8. COVERAGE AND SENSITIVITY	12
9. ASSEMBLY	13
10. SETUP AND CODE GENERATION PROCEDURES	15
10.1. SETUP procedure	15
10.2. Code self-generation and storing procedures	15
11. DISPOSAL CONSIDERATIONS	16
12. CONTENTS	16

LUPUS and VOLANS models advanced wireless transmitters for wireless intrusion detection systems
TECHNICAL AND PROGRAMMING MANUAL

Issue October 2004

090000267

This informations and the characteristics of the products as described above are not binding on the manufacturer and may be altered without notice.

EL.MO. SpA

Tel. +39 0499203333 (R.A.) - Fax +39 0499200306 - Ass. Tecnica +39 0499200426 - www.elmo.it - info@elmo.it