

Modbus RTU (EIA-485) Interface for LG air conditioners

USER MANUAL

Issue date: 11/2021 r1.8 ENGLISH



Modbus RTU (EIA-485) Interface for LG air conditioners

ORDER CODE	LEGACY ORDER CODE
INMBSLGE001R000	LG-RC-MBS-1

Important User Information

Disclaimer

The information in this document is for informational purposes only. Please inform HMS Industrial Networks of any inaccuracies or omissions found in this document. HMS Industrial Networks disclaims any responsibility or liability for any errors that may appear in this document.

HMS Industrial Networks reserves the right to modify its products in line with its policy of continuous product development. The information in this document shall therefore not be construed as a commitment on the part of HMS Industrial Networks and is subject to change without notice. HMS Industrial Networks makes no commitment to update or keep current the information in this document.

The data, examples and illustrations found in this document are included for illustrative purposes and are only intended to help improve understanding of the functionality and handling of the product. In view of the wide range of possible applications of the product, and because of the many variables and requirements associated with any particular implementation, HMS Industrial Networks cannot assume responsibility or liability for actual use based on the data, examples or illustrations included in this document nor for any damages incurred during installation of the product. Those responsible for the use of the product must acquire sufficient knowledge in order to ensure that the product is used correctly in their specific application and that the application meets all performance and safety requirements including any applicable laws, regulations, codes and standards. Further, HMS Industrial Networks will under no circumstances assume liability or responsibility for any problems that may arise as a result from the use of undocumented features or functional side effects found outside the documented scope of the product. The effects caused by any direct or indirect use of such aspects of the product are undefined and may include e.g. compatibility issues and stability issues.

INDEX

1. Presentation 5

2. Connection 6

 2.1 Connect to the AC indoor unit 6

 2.2 Connection to the EIA-485 bus 7

3. Quick Start Guide..... 7

4. Modbus Interface Specification 8

 4.1 Modbus physical layer..... 8

 4.2 Modbus Registers..... 8

 4.2.1 Control and status registers 8

 4.2.2 Configuration Registers..... 10

 4.2.3 Considerations on Temperature Registers 11

 4.3 DIP-switch Configuration Interface 14

 4.4 Implemented Functions 17

 4.5 Device LED indicator 17

 4.6 EIA-485 bus. Termination resistors and Fail-Safe Biasing mechanism 18

5. Mechanical and electrical features 19

6. List of supported AC Unit Types. 20

7. Error Codes 21

1. Presentation



The INMBSLGE001R000 interfaces allow a complete and natural integration of **LG** air conditioners into Modbus RTU (EIA-485) networks.

Reduced dimensions. 93 x 53 x 58 mm
3.7" x 2.1" x 2.3"

Quick and easy installation.
Mountable on DIN rail, wall, or even inside the indoor unit of AC.

- External power not required.
- Direct connection to Modbus RTU (EIA-485) networks. Up to 63 INMBSLGE001R000 devices can be connected in the same network.
INMBSLGE001R000 is a Modbus slave device.
- Direct connection to the AC indoor unit.
- Configuration from both on-board DIP-switches and Modbus RTU.
- Total Control and Supervision.
- Real states of the AC unit's internal variables.
- Allows simultaneous use of the AC's remote controls and Modbus RTU.

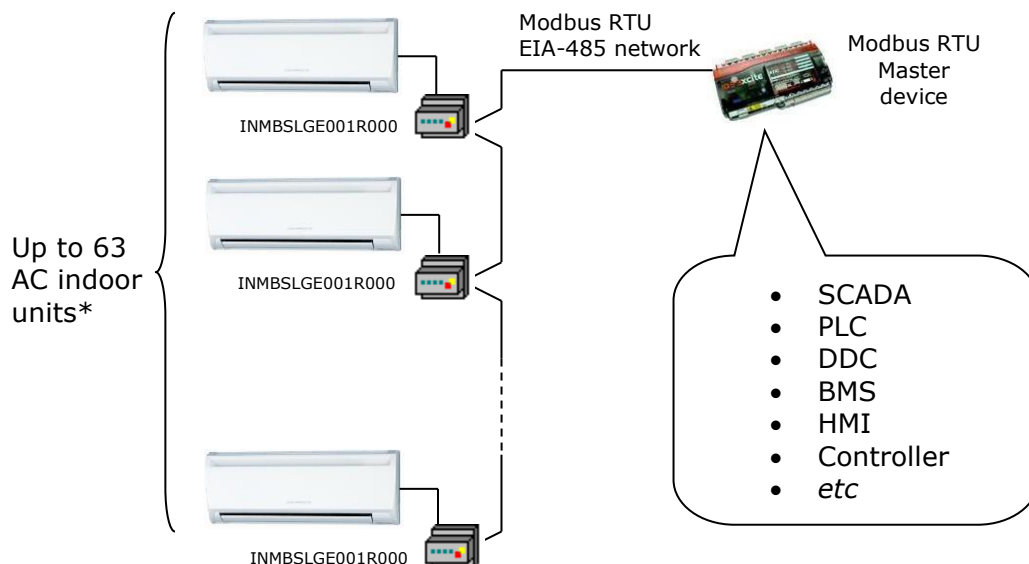

* Up to 63 Intesis devices can be installed in the same Modbus RTU bus. However, depending on the configured speed, the installation of Modbus Repeaters may be required

2. Connection

The interface comes with a plug-in terminal block of 3 poles to establish direct connection with the AC indoor unit. It comes as well with a plug-in terminal block of 2 poles to establish direct connection with the Modbus RTU EIA-485 network.

2.1 Connect to the AC indoor unit

The INMBSLGE001R000 connects directly to the LG BYR Bus, which is not provided within the interface. Depending on which controllers are available, the recommended connection methods are the following ones (details in Figure 2. 1):

- **Wired remote control available.** Connect the gateway as Slave in parallel with the wired Remote Controllers (Controller acts as Master).
- **No remote control available** Connect the gateway directly to the BYR bus of the indoor unit as Master when there is no LG Remote Controller.

Maximum BYR bus length is 50 m / 164.04 ft. The bus has no polarity sensitivity.

Important: If a wired remote controller of the AC manufacturer is connected in the same bus, communication may shut down.

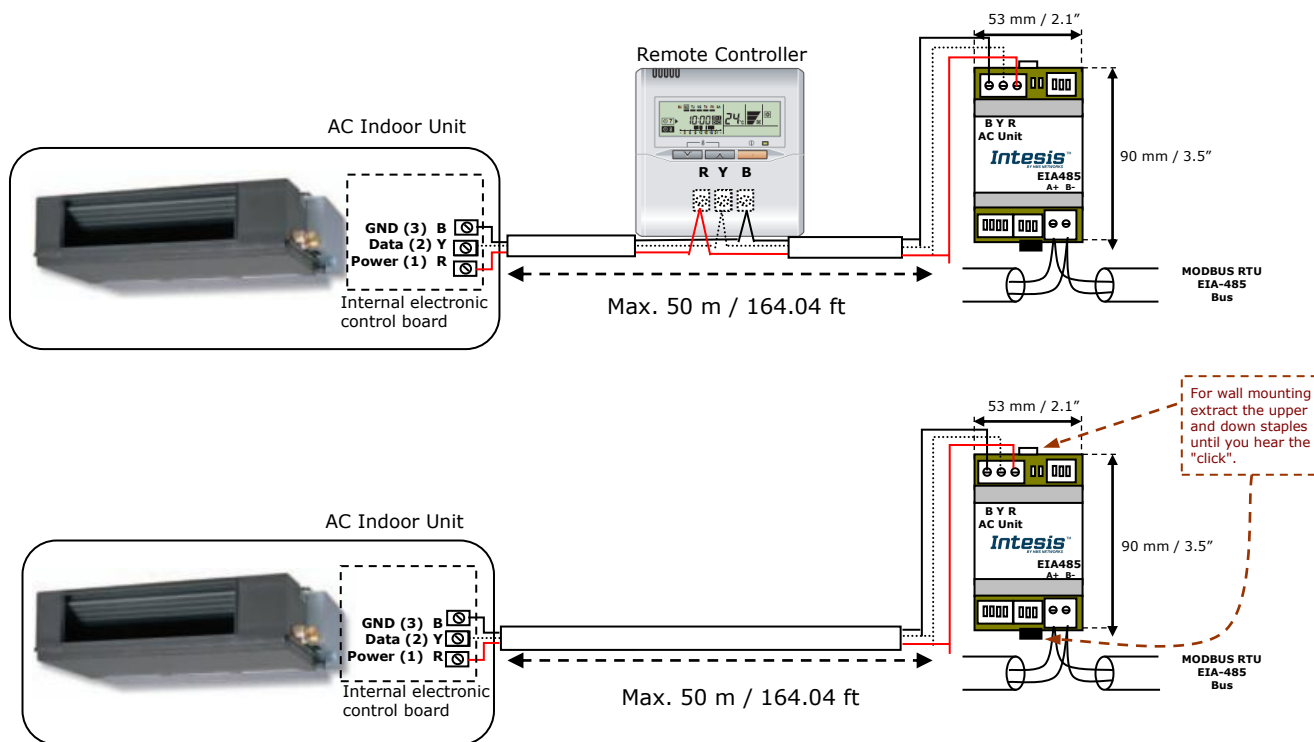

Attention: Type A units don't allow to install a Remote Controller and INMBSLGE001R000 together.

Figure 2. 1 INMBSLGE001R000 connection diagram

2.2 Connection to the EIA-485 bus

Connect the EIA-485 bus wires to the plug-in terminal block (the one of two poles) of INMBSLGE001R000 and keep the polarity on this connection (A+ and B-). Make sure that the maximum distance to the bus is 1,200 meters (3,937 ft). Loop or star typologies are not allowed in the case of the EIA-485 bus. A terminator resistor of 120Ω must be present at each end of the bus to avoid signal reflections. The bus needs a fail-safe biasing mechanism (see section 4.6 for more details).

3. Quick Start Guide

1. Disconnect the air conditioning from the Mains Power.
2. Attach the interface next to the AC indoor unit (wall mounting) following the instructions of the diagram below or install it inside the AC indoor unit (respect the safety instructions given).
3. Connect the BYR bus between the interface and the AC indoor unit following the instructions of the diagram. Screw each bare cable end in the corresponding BYR terminals of each device.
4. Connect the EIA-485 bus to the connector *EIA485* of the interface.
5. Close the AC indoor unit.
6. Check the DIP-Switch configuration of the Intesis interface and make sure it matches the current installation's parameters.

By default, the interface is set to:

- Modbus Slave Address → 1
- Modbus baud rate → 9600 bps



These parameters can be modified from SW4 and SW3 DIP-Switches.

All other switch positions are set at low level (Off position ) by default.

NOTE: All changes on the DIP-Switch configuration require a system power cycle to be applied.

7. Connect the AC system to Mains Power.

IMPORTANT: The Intesis interface requires to be connected to the AC unit (powered) to start communicating.

4. Modbus Interface Specification

4.1 Modbus physical layer

INMBSLGE001R000 implements a Modbus RTU (Slave) interface, to be connected to an EIA-485 line. It performs 8N2 communication (8 data bits, no parity and 2 stop bit) with several available baud rates (2400 bps, 4800 bps, 9600 bps -default-, 19200 bps, 38400 bps, 57600 bps, 76800 bps and 115200 bps). It also supports 8N1 communication (8 data bits, no parity and 1 stop bit).

4.2 Modbus Registers

All registers are type "16-bit unsigned Holding Register" and they use the *Modbus big endian* notation.

4.2.1 Control and status registers

Register Address (protocol address)	Register Address (PLC address)	R/W	Description
0	1	R/W	AC unit On/Off <ul style="list-style-type: none"> ▪ 0: Off ▪ 1: On
1	2	R/W	AC unit Mode ¹ <ul style="list-style-type: none"> ▪ 0: Auto ▪ 1: Heat ▪ 2: Dry ▪ 3: Fan ▪ 4: Cool
2	3	R/W	AC unit Fan Speed ¹ <ul style="list-style-type: none"> ▪ 0: Auto ▪ 1..7: Pos. 1 .. Pos. 7
3	4	R/W	AC unit Vane Position ¹ <ul style="list-style-type: none"> ▪ 0: No Swing ▪ 1..4: Pos. 1 .. Pos. 4 ▪ 10: Swing ▪ 11: Swirl
4	5	R/W	AC unit Temperature Setpoint ^{1,2,3} <ul style="list-style-type: none"> ▪ -32768 (Initialization value) ▪ 16..30°C (°C/x10°C) ▪ 61..86°F
5	6	R	AC unit Temperature reference ^{1,2,3} <ul style="list-style-type: none"> ▪ -32768 (Initialization value) ▪ 10..38°C (°C/x10°C) ▪ 50..100°F
6	7	R/W	Window Contact <ul style="list-style-type: none"> ▪ 0: Closed (Default) ▪ 1: Open

¹ Available values will depend on the AC unit mode. Check the AC unit model functions in its user manual to know the possible values for this register.

² Magnitude for this register can be adjusted to Celsius x 1°C, Celsius x 10°C (default) or Fahrenheit. See section 4.2.3 for more information.

³ It is not possible turn to x10 the value shown in Fahrenheit.

Register Address (protocol address)	Register Address (PLC address)	R/W	Description
7	8	R/W	INMBSLGE001R000 Disablement ⁴ <ul style="list-style-type: none"> 0: INMBSLGE001R000 enabled (Default) 1: INMBSLGE001R000 disabled
8	9	R/W	AC Remote Control Disablement ⁴ <ul style="list-style-type: none"> 0: Remote Controller enabled (Default) 1: Remote Controller disabled
9	10	R/W	AC unit Operation Time ⁴ <ul style="list-style-type: none"> 0..65535 (hours). Counts the time the AC unit is in "On" state.
10	11	R	AC unit Alarm Status <ul style="list-style-type: none"> 0: No alarm condition 1: Alarm condition
11	12	R	Error Code ⁵ <ul style="list-style-type: none"> 0: No error present 65535(-1 if it is read as signed value): Error in the communication of INMBSLGE001R000 or Remote Controller with the AC unit. If any error is present, see the table at the end of this document.
22	23	R/W	Indoor unit's ambient temperature from external sensor (at Modbus side) ^{1,2,3,6} <ul style="list-style-type: none"> -32768: (Initialization value). No temperature is being provided from an external sensor. Any from Manufacturer: (°C/x10°C/°F)
23	24	R	AC Real setpoint temperature ^{1,2,3,6} <ul style="list-style-type: none"> When no external temperature is provided, this read-only register will have the same value as register 5 (PLC addressing). In all cases, it will show the current setpoint in the indoor unit. Any from Manufacturer: (°C/x10°C/°F)
24	25	R	Current AC max setpoint ^{1,2,3} <ul style="list-style-type: none"> -32768 (Initialization value) Any from Manufacturer: (°C/x10°C/°F)
25	26	R	Current AC min setpoint ^{1,2,3} <ul style="list-style-type: none"> -32768 (Initialization value) Any from Manufacturer: (°C/x10°C/°F)
26	27	R/W	AC unit Left/Right Vane Position ¹ <ul style="list-style-type: none"> 0: Auto (Default) 1..9: Pos. 1 .. Pos. 9 10: Swing
27	28	R/W	Up/Down Vane Position <ul style="list-style-type: none"> 1: Pulse
31	32	R	Status (feedback) <ul style="list-style-type: none"> 0: Not active (Default value) 1: Active (A window is open)
53	54	R	Compressor Status <ul style="list-style-type: none"> 0: Off 1: To Off 2: To On 3: On

⁴ This value is stored in non-volatile memory

⁵ See section 7 for possible error codes and their explanation

⁶ See section 4.2.3 for more information

Register Address (protocol address)	Register Address (PLC address)	R/W	Description
54	55	R/W	Compressor on Time ⁴ <ul style="list-style-type: none"> 0..65535 (hours). Counts the time the Compressor is in "On" state.
65	66	R	Input Ref. Temperature (feedback) ^{1,2,3} <ul style="list-style-type: none"> -32768 (Initialization value) Any from Manufacturer: (°C/x10°C/°F)
97	98	R/W	Block Periodic Sendings ^{4,7,8} <ul style="list-style-type: none"> 0: Non-blocked (Default value) 1: Blocked
98	99	R/W	Master/Slave (gateway's role) <ul style="list-style-type: none"> 0: Slave 1: Master

4.2.2 Configuration Registers

Register Address (protocol address)	Register Address (PLC address)	R/W	Description
13	14	R/W	"Open Window" switch-off timeout ⁹ <ul style="list-style-type: none"> 0..30 (minutes) Factory setting: 30 (minutes)
14	15	R	Modbus RTU baud-rate <ul style="list-style-type: none"> 2400bps 4800bps 9600bps (Default) 19200bps 38400bps 57600bps 76800bps 115200bps
15	16	R	Modbus Slave Address <ul style="list-style-type: none"> 1..63
21	22	R	Max number of fan speeds
48	49	R	Switch value
49	50	R	Device ID: 0x1000
50	51	R	Software version
99	100	R/W	Reset <ul style="list-style-type: none"> 1:Reset

⁷ If the register is configured as "0:Non-blocked", all commands received from Modbus will be sent to the AC system. If "1: Blocked", commands from Modbus will only be sent to the AC system if they differ from the previous value.

⁸ This register applies to firmware version 1.7 onwards

⁹ Once window contact is open, a count-down to switch off the AC Unit will start from this configured value.

4.2.3 Considerations on Temperature Registers

- **AC unit temperature setpoint (R/W)**
(register 4 – in Protocol address / register 5 – in PLC address):
This is the adjustable temperature setpoint value that must be required by the user. This register can be read (Modbus function 3 or 4) or written (Modbus functions 6 or 16). A remote controller connected to the LG indoor unit will report the same temperature setpoint value as this register, but only will happen when no AC unit's external reference is provided from INMBSLGE001R000 (see detail for register 22/23 below).
- **AC unit temperature reference (R)**
(register 5 – in Protocol address / register 6 – in PLC address):
This register reports the temperature that is currently used by the LG indoor unit as the reference of its own control loop. Depending on the configuration of the indoor unit, this value can be the temperature reported by the sensor on the return path of the LG indoor unit or the sensor of its remote controller. It is a read-only register (Modbus functions 3 or 4).
- **AC unit external temperature reference (Modbus) (R/W)**
(register 22 – in Protocol address / register 23 – in PLC address):
This register allows us to provide an external temperature's sensor from the Modbus side. LG indoor unit does not allow on devices like INMBSLGE001R000 to provide directly temperature to be used as a reference of the control loop of the AC indoor unit. In order to overcome this limitation and enable the usage of an external temperature sensor (i.e. from Modbus side), INMBSLGE001R000 applies the following mechanism (only if "external temperature's reference" is being used):
 - After a couple of values have been entered in the "AC unit external temperature's reference" (register 22/23) and "AC unit temperature set point" (register 4/5), INMBSLGE001R000 is going to estimate the temperature chosen implied (e.g. if a "temperature setpoint (register 4/5)" of **22°C**, and an "external temperature reference (register 22/23)" of **20°C** are entered, INMBSLGE001R000 will assume that the user is demanding a **+2°C** increase in temperature).
 - By knowing at any time the ambient temperature currently used by the indoor unit to control its own operation (register 5/6), INMBSLGE001R000 can calculate the required temperature setpoint needed to apply the decrease/increase on the real temperature and reach the temperature chosen by the user (following the example above, if INMBSLGE001R000 reads an "ambient temperature" (register 5/6) of **24°C** in the indoor unit, it will apply a final setpoint of **24°C + 2°C = 26°C**).
 - At this moment, each time that INMBSLGE001R000 detects a change on the ambient temperature reported by the indoor unit (register 5/6), it will also change the required setpoint, in order to keep the temperature required by the user at any time. If we follow the last example, if INMBSLGE001R000 receives a new temperature's value coming from the indoor unit of **25°C**, INMBSLGE001R000 will automatically adjust the temperature setpoint required of the AC indoor unit to **25°C + 2°C = 27°C**).
 - In general, INMBSLGE001R000 is constantly applying the "Virtual Temperature" formula:

$$S_{AC} = S_u - (T_u - T_{AC})$$

Where:

- S_{AC} - setpoint value currently applied to the indoor unit
- S_u - setpoint value written at Modbus side (register 4/5)
- T_u - external temperature reference written at Modbus side (register 22/23)
- T_{AC} - ambient temperature that the indoor unit is using as the reference of its own control loop (register 5/6)

When INMBSLGE001R000 detects a change in any of the values of $\{ S_u, T_u, T_{AC} \}$, it will send the new setpoint (S_{AC}) to the indoor unit.

- After the startup, the value for "external temperature's reference" (register 22/23) has a value -32768 (0x8000). This value means that no external temperature reference is being provided through INMBSLGE001R000. In this scenario, the setpoint value shown in register 4/5 will always be the same as the current setpoint value of the indoor unit. AC indoor unit will use its own return path temperature sensor as reference for its control loop.
 - When the mechanism of "Virtual Temperature" is applied. The temperature setpoint's value shown by the Remote Controller or other Control System from LG connected to the indoor unit may show a different value from the value shown in register 4/5.
 - If it is desired to use the temperature's reading from the Remote Control as the reference temperature for the Indoor Unit (T_{AC}), the Remote Controller must be configured as Master, and the LG AC indoor unit must have the option "thermostat sensor in the Remote Controller" activated. This configuration is done via a LG Remote Controller connected to the indoor unit and must be done by LG authorized installers while the AC is being installed.
 - When INMBSLGE001R000 is set as "Master" of the BYR bus and the LG AC Indoor unit has the option "thermostat sensor in the Remote Controller" activated. The external temperature's sensor connected to Modbus RTU EIA-485 network provides directly the value currently applied to the indoor unit (S_{AC}), and the process of the Virtual temperature is not applied. In this case, the Remote Controller or any other Control System connected from LG is not able to send the external temperature reference's value to the register 22/23.
- **AC Real Setpoint temperature (R)**
(register 23 – In Protocol address / register 24 – in PLC address):

As it has been detailed on the previous point, the real temperature setpoint in the indoor unit and the temperature setpoint requested from INMBSLGE001R000 might differ (when a value in register 22/23 – "external temperature reference" is entered). This register always informs about the current temperature setpoint which is being used by the indoor unit – it also includes the temperature setpoint that will be shown by an additional remote controller from LG connected to the indoor unit, if it is present on the system.

Moreover, notice that temperature's values of all these four registers are expressed according to the temperature's format configured through its onboard DIP-Switches (See "4.3 - DIP-switch Configuration Interface"). These following formats are possible:

- **Celsius value:** Value in Modbus register is the temperature value in Celsius (i.e. a value "22" in the Modbus register must be interpreted as 22°C).
- **Decicelsius value:** Value in Modbus register is the temperature value in decicelsius (i.e. a value "220" in the Modbus register must be interpreted as 22.0°C).
- **Fahrenheit value:** Value in Modbus register is the temperature value in Fahrenheit (i.e. a value "72" in the Modbus register must be interpreted as 72°F (~22°C)).

4.3 DIP-switch Configuration Interface

All the configuration values on INMBSLGE001R000 can be written and read from Modbus interface. Otherwise, some of them can also be setup from its on-board DIP-switch interface. The device has DIP-switches SW1, SW3 and SW4 on the following locations:

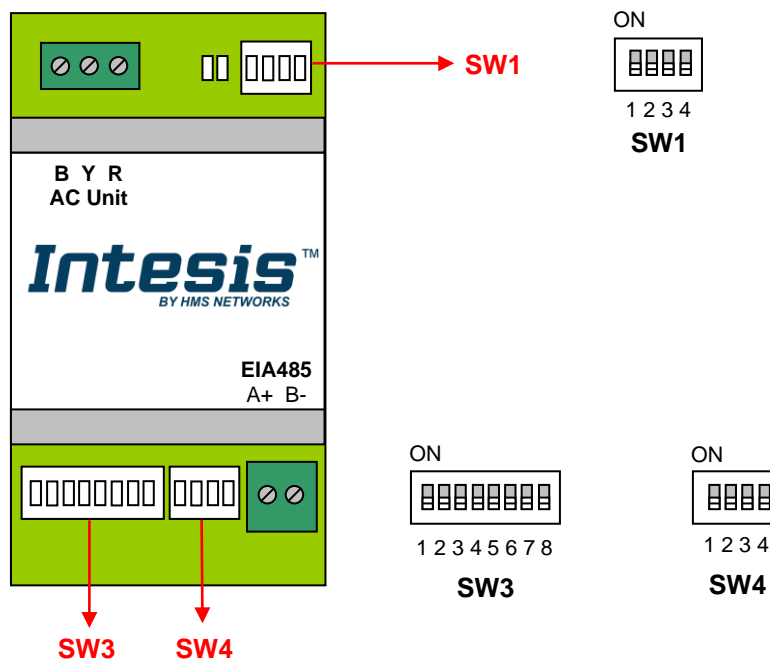

The following tables apply to the interface's configuration through DIP-switches:

SW1 – AC indoor unit's features

SW1-P1..4	Description
	Slave - A LG Controller must be present in BYR bus, configured as Master (Default value)
	Master - LG Controller not needed in BYR bus. If it exists, it must be configured as Slave
	Error Type_B - Machine must be Type B (Default value)
	Error Type_A - Machine must be Type A
	Min. ambient temperature not applied (Default value)
	Min. ambient temperature applied
	Keep the switch into this position (Default value)
	Do not turn the switch into this position (not applicable)

Table 4.1 SW1: AC indoor unit 's features

SW3/SW4 – Baud rate configuration















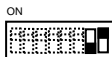

SW3-P7..8	SW4-P3	Description
		2400bps
		4800bps
		9600bps (Default value)
		19200bps
		38400bps
		57600bps
		76800bps
		115200bps

Table 4.2 SW3-SW4: Modbus baud rate

SW4 – Degrees/Decidegrees (x10), temperature magnitude (°C/°F) and EIA-485 termination resistor.







SW4-P1..2-4	Description
	Temperature values in Modbus register are represented in degrees (x1) (Default value)
	Temperature values in Modbus register are represented in decidegrees (x10)
	Temperature values in Modbus register are represented in Celsius degrees (Default value)
	Temperature values in Modbus register are represented in Fahrenheit degrees
	EIA-485 bus without termination resistor (Default value)
	Internal termination resistor of 120Ω connected to EIA-485 bus

Table 4.3 SW4: Temperature and termination resistor configuration

SW3 – Modbus Slave address

Add	SW3-P1..6	Add	SW3-P1..6	Add	SW3-P1..6	Add	SW3-P1..6	Add	SW3-P1..6
0		13		26		39		52	
1		14		27		40		53	
2		15		28		41		54	
3		16		29		42		55	
4		17		30		43		56	
5		18		31		44		57	
6		19		32		45		58	
7		20		33		46		59	
8		21		34		47		60	
9		22		35		48		61	
10		23		36		49		62	
11		24		37		50		63	
12		25		38		51			

Table 4.4 SW3: Modbus slave address

4.4 Implemented Functions

INMBSLGE001R000 implements the following standard Modbus functions:

- 3: Read Holding Registers
- 4: Read Input Registers
- 6: Write Single Register
- 16: Write Multiple Registers (Despite this function is allowed, the interface does not allow to write operations on more than 1 register with the same request, this means that length field should be always be 1 when this function is being used in case of writing)

4.5 Device LED indicator

The device includes two LED indicators to show all the possible operational states. In the following table there are written the indicators which can be performed and their meaning.

L1 (green LED)

Device status	LED indication	ON / OFF Period	Description
During not normal operation	LED blinking	500ms ON / 500ms OFF	Communication error
During normal operation	LED flashing	100ms ON / 1900ms OFF	Normal operation (configured and working properly)

L2 (red LED)

Device status	LED indication	ON / OFF Period	Description
During not normal operation	LED Pulse	3sec ON / --- OFF	Under voltage

L1 (green LED) & L2 (red LED)

Device status	LED indication	ON / OFF Period	Description
During normal operation	LED Pulse	5sec ON / --- OFF	Device Start-up
During not normal operation	LED alternatively blinking	500ms ON / 500ms OFF	Flash checksum not OK

4.6 EIA-485 bus. Termination resistors and Fail-Safe Biasing mechanism

EIA-485 bus requires a 120Ω terminator resistor at each end of the bus to avoid signal reflections.

In order to prevent fail status detected by the receivers, which are "*listening*" the bus, when all the transmitters' outputs are in three-state (high impedance), it is also required a fail-safe biasing mechanism. This mechanism provides a safe status (a correct voltage level) in the bus when all the transmitters' outputs are in three-state. This mechanism must be supplied by the Modbus Master.

The INMBSLGE001R000 device includes an on-board terminator resistor of 120Ω that can be connected to the EIA-485 bus by using DIP-switch SW4.

Some Modbus RTU EIA-485 Master devices can provide also internal 120Ω terminator resistor and/or fail-safe biasing mechanism (Check the technical documentation of the Master device connected to the EIA-485 network in each case).

5. Mechanical and electrical features

Enclosure	Plastic, type PC (UL 94 V-0) Net dimensions (dxwxh): 93 x 53 x 58 mm / 3.7" x 2.1" x 2.3" Color: Light Grey. RAL 7035	Operation Temperature	0°C to +60°C
Weight	85 g.	Stock Temperature	-20°C to +85°C
Mounting	Wall DIN rail EN60715 TH35.	Operational Humidity	<95% RH, non-condensing
Terminal Wiring (for low-voltage signals)	For terminal: solid wires or stranded wires (twisted or with ferrule) 1 core: 0.5mm ² ... 2.5mm ² 2 cores: 0.5mm ² ... 1.5mm ² 3 cores: not permitted	Stock Humidity	<95% RH, non-condensing
Modbus RTU port	1 x Serial EIA485 Plug-in screw terminal block (2 poles): A, B Compatible with Modbus RTU EIA-485 networks	Isolation voltage	1500 VDC
AC unit port	1 x BYR bus Plug-in screw terminal block (3 poles): B, Y, R Compatible with LG networks	Isolation resistance	1000 MΩ
Switch 1 (SW1)	1 x DIP-Switch for AC features	Protection	IP20 (IEC60529)
Switch 3 (SW3)	1 x DIP-Switch for Modbus RTU settings	LED indicators	2 x Onboard LED - Operational status
Switch 4 (SW4)	1 x DIP-Switch for extra functions		

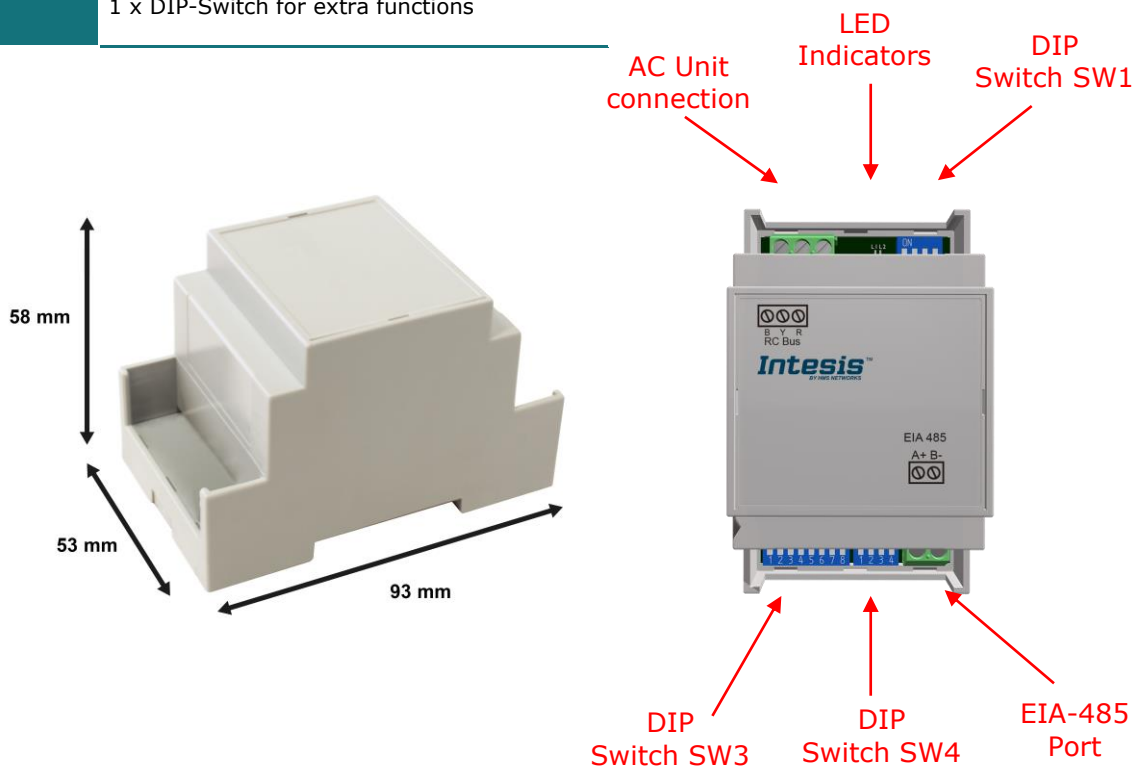

6. List of supported AC Unit Types.

A list of LG indoor unit model's references compatible with INMBSLGE001R000 and its available features can be found on this link:

https://www.intesis.com/docs/compatibilities/inxxxlqe001r000_compatibility

7. Error Codes

Error Code Modbus	Remote Controller Error	Error description
0	N/A	No active error
1	1	Room air sensor fault
2	2	Indoor unit pipe in sensor fault
3	3	Communication fault between wired remote controller and indoor unit
4	4	Drain pump fault
5	5	Communication fault between indoor unit and outdoor unit
6	6	Indoor unit pipe out sensor fault
7	7	Indoor unit mode runs on opposite to outdoor unit
8	8	N/A
9	9	EEPROM memory fault
10	10	BLDC motor signal fault or motor lock
11	11	HEX middle point sensor fault
12	12	heater terminal block sensor fault
13	13	N/A
14	14	N/A
15	15	N/A
16	16	N/A
17	17	Outlet air sensor fault
18	18	Return air sensor fault
19	19	No communication response from sub PCB to main PCB
20	20	No communication response from main PCB to sub PCB
21	21	IPM fault
22	22	AC input is over current (RMS)
23	23	DC link low or high voltage
24	24	High pressure or low pressure switch on
25	25	High/low input voltage
26	26	Compressor start failure
27	27	PSC/PFC fault
28	28	DC link high voltage
29	29	Over current at compressor input
32	32	Discharge temperature is high at inverter compressor
33	33	Discharge temperature is high at constant speed compressor
34	34	High pressure is too high
35	35	Low pressure is too low
36	36	Compression ratio is too low
39	39	Communication fault between PFC and inverter PCB
40	40	CT sensor fault
41	41	Discharge sensor at inverter compressor is fault
42	42	Low pressure sensor is fault
43	43	High pressure sensor is fault
44	44	Air sensor at outdoor unit is fault
45	45	HEX sensor at outdoor unit is fault
46	46	Compressor suction sensor is fault
47	47	Discharge sensor at constant speed compressor is fault
48	48	HEX outlet sensor at outdoor unit is fault
49	49	IPM temperature sensor is fault
50	50	Missing phase among 3 phase
51	51	Over combination ratio
52	52	No communication from inverter PCB detected at main PCB
53	53	Communication fault between indoor and outdoor unit
54	54	Reverse phase is detected
57	57	No communication from main PCB detected at inverter PCB

59	59	Wrong outdoor unit combination
60	60	Inverter EEPROM memory fault
61	61	Outdoor pipe temperature is too high
62	62	IPM temperature is too high
65	65	IPM temperature sensor is fault
67	67	Fan locked or fan start failure
69	69	CT sensor of constant speed compressor 1 is fault
70	70	CT sensor of constant speed compressor 2 is fault
71	71	PFC CT sensor fault
72	72	Function error of outdoor 4way valve (reversing valve)
73	73	DC peak current is over
74	74	Unbalance at 3 phase
75	75	Fan CT sensor fault
76	76	Fan DC link voltage is high
77	77	Fan input voltage is high
78	78	Fan hall sensor fault
79	79	Fan motor start failure
86	86	Main PCB EEPROM is fault
87	87	Fan PCB EEPROM is fault
88	88	PFC PCB EEPROM is fault
90	90	Inlet temperature sensor of external PCB is fault
91	91	Outlet temperature sensor of external PCB is fault
104	104	No Communication from slave is detected
105	105	Communication fault between fan and inverter PCB
106	106	Fan PCB IOM fault
107	107	Fan DC link voltage is low
113	113	Liquid pipe sensor fault
114	114	Sub-cooling inlet pipe sensor fault
115	115	Sub-cooling outlet pipe sensor fault
116	116	Oil level sensor fault
145	145	No communication from external PCB is detected at main PCB
151	151	4 way valve failure
153	153	Upper HEX sensor fault
154	154	Bottom HEX sensor fault
173	173	Over / low current at constant speed compressor 1
174	174	Over / low current at constant speed compressor 2
182	182	Communication fault between main and sub micom in external PCB
187	187	Hydro-kit water temperature sensor fault
190	190	Inverter PCB heat sink temperature is high
191	191	Inverter PCB heat sink temperature sensor fault
193	193	Fan PCB heat sink temperature is high
194	194	Fan PCB heat sink temperature sensor fault
200	200	Auto piping failure
201	201	Fault at liquid pipe sensor of Heat Recovery (HR) unit
202	202	Fault at sub-cooling inlet pipe sensor of Heat Recovery (HR) unit
203	203	Fault at sub-cooling outlet pipe sensor of Heat Recovery (HR) unit
204	204	No communication from outdoor unit is detected at the Heat Recovery (HR) unit
205	205	HR unit addresses are duplicated
237	237	No response from outdoor unit modem at indoor unit modem
238	238	No response from outdoor unit at outdoor unit modem
65535 (-1)	N/A	Error in the communication of INMBSLGE001R000 or Remote Controller with the AC unit.

In case to detect an error code not listed, contact your closest LG technical support service.