

# WatchOUT™ *eXtreme*

Reliable Outdoor Detection

**Dual Technology Outdoor Detector**  
**Rivelatore da Esterno a Doppia Tecnologia**  
**Detector de Exterior de Doble Tecnología**  
**Détecteur extérieur à double technologie**  
**Detector Externo de Dupla Tecnologia**  
**Dual Technology-Buitendetector**

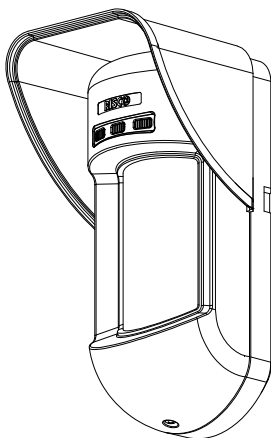

## WatchOUT 315DT

**Installation Instructions - Relay & BUS Modes**  
**Istruzioni per l'installazione in modalità Relé e BUS**  
**Instrucciones de Instalación - Modos Relé y BUS**  
**Guide d'installation - Modes Relais et BUS**  
**Instruções de Instalação - Modos Relé & BUS**  
**Relais- & BUS-modusinstallatie-instructies**

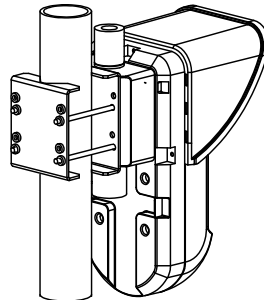
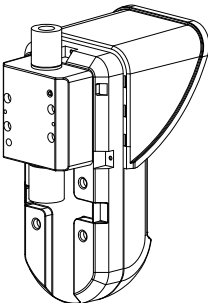
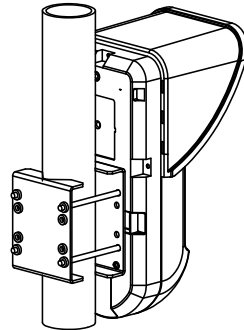
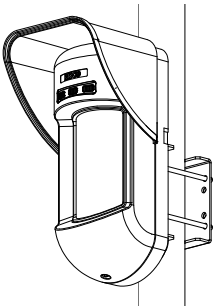
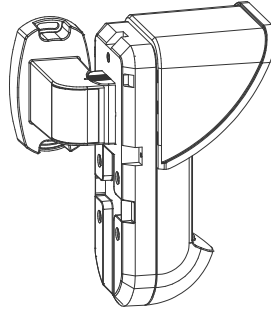
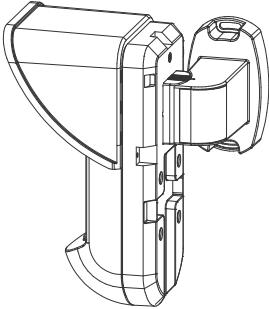
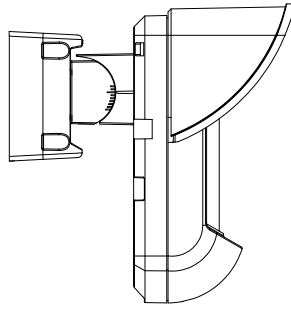
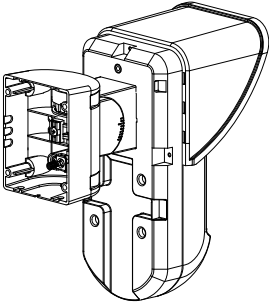

# Table of Contents

<b>Relay Mode Installation</b> .....	<b>4</b>
<b>Introduction</b> .....	<b>4</b>
<b>Mounting</b> .....	<b>4</b>
Mounting Considerations .....	4
Wall Mount Installation .....	5
Flat Mounting: .....	5
45° angle Mounting (Left side mounting) .....	5
Changing Back Tamper position .....	6
<b>Terminal Wiring</b> .....	<b>6</b>
<b>DIP Switch Settings</b> .....	<b>7</b>
<b>Microwave Adjustment</b> .....	<b>7</b>
Walk test .....	7
<b>LEDs Display</b> .....	<b>7</b>
<b>Relay Mode / BUS Mode Jumper</b> .....	<b>8</b>
<b>Standard Swivel Installation</b> .....	<b>8</b>
Wall Mounting .....	8
Swivel Conduit Mounting .....	8
<b>Replacing a Lens</b> .....	<b>10</b>
Lenses Types .....	11
<b>Technical Specification</b> .....	<b>12</b>
<b>Ordering Information</b> .....	<b>12</b>
<b>UL Compliance Section</b> .....	<b>12</b>
<b>BUS Mode Installation</b> .....	<b>14</b>
<b>Introduction</b> .....	<b>14</b>
<b>Terminal Wiring</b> .....	<b>14</b>
<b>DIP Switch Settings</b> .....	<b>14</b>
<b>ProSYS Programming</b> .....	<b>15</b>
<b>New System Parameters</b> .....	<b>17</b>

# Relay Mode Installation

## Introduction

RISCO Group's Dual Technology Outdoor Detector, WatchOUT 315DT, is a unique detector with signal processing based on two Passive Infrared (PIR) channels and two Microwave (MW) channels. The detector can operate as a regular relay detector connected to any control panel, or as a BUS accessory when connected to RISCO Group's ProSYS control panel via the RS485 BUS, thus having unique remote control and diagnostic capabilities.

The instructions describe herein, describe the WatchOUT 315DT in Relay & BUS mode.

## Mounting

### Mounting Considerations

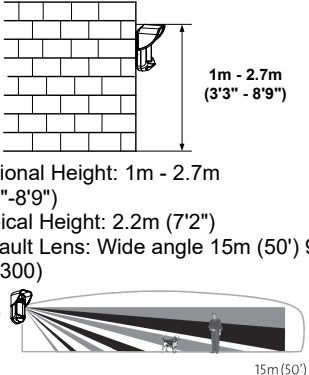
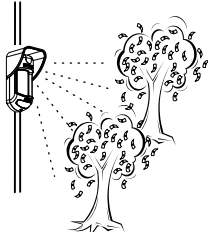
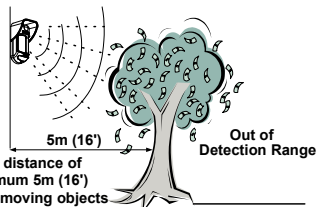
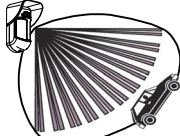
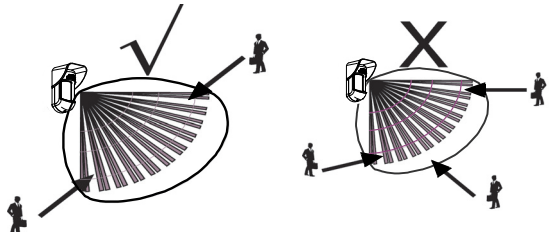
 <p>Optional Height: 1m - 2.7m (3'3"-8'9")          Typical Height: 2.2m (7'2")          Default Lens: Wide angle 15m (50') 90° (RL300)</p> <p><b>Note:</b></p> <ol style="list-style-type: none"> <li>1. For low installations, below 1.7m (5'6") in which pet immunity is required, use the supplied RL300F lens (low wall or fence installations).</li> <li>2. The detector's pet immunity (height of an animal, no weight limitation), is up to 70 cm (2'4"), when installing the detector at 2.2m (7'2"). If the installation is below the height mentioned above, the Pet Immunity decreases accordingly; every 10 cm (4") decrease in installation height leads to 10 cm (4") decrease in pet immunity.</li> </ol>	 <p>If possible, avoid pointing the detector to moving objects (swaying trees, bushes etc.)</p>  <p>Keep distance of minimum 5m (16') from moving objects</p> <p>Out of Detection Range</p> <p>Ensure any objects do not obstruct the field of view for both technologies. Pay attention to growing trees or bushes, plants with big moving leaves etc</p>
<p>For installations with extensive vehicle traffic or targets beyond the required detection range, it is recommended to adjust the MW sensitivity and/or to tilt the detector down.</p> <p><b>Note:</b>          Tilting the detector down may reduce the pet immunity</p>	
<p>For optimum detection, select a location that is likely to intercept an intruder moving across the coverage pattern at a 45° trajectory.</p> 	
<p><b>NOTE:</b> Disable Proximity AM during heavy rain (if WatchOUT 315DT is not sheltered) to prevent Proximity AM alerts.</p>	

## Wall Mount Installation

### Note:

The installation knockouts numbering are marked on the back plate.

1. Open WatchOUT front cover (unlock C1, Figure 1).
2. Release internal base (unlock I1, Figure 2).
3. Select mounting installation as follows:

### Flat Mounting:

Open knockouts on external base (Figure 3).

- B1 - B4: Wall mounting knockouts
- T1: Back tamper knockout
- W2 / W3: wires entry knockouts

### 45° angle Mounting (Left side mounting)

- a. Open knockouts on external base (Figure 3)
  - L1, L2: Left mounting knockouts
  - T3: Left tamper knockout
  - W5 / W6: Wire entry knockouts
- b. Remove tamper spring.
- c. Replace tamper bracket (Item 1) with supplied flat tamper bracket (Item 2).



- d. Insert Tamper lever B onto T5 and T3 and secure screw A (Figure 3).
4. Insert external wires through external base W2, W3 (Flat Mounting) or W5, W6 (Left side mounting) (Figure 3).
  5. Secure external base to the wall.
  6. Insert external wires and tamper wires through internal base (Figure 4).
  7. Secure internal base to external base (lock I1, Figure 2).
  8. Close the front cover (Lock C1, Figure 1) after wiring and setting DIP switches.
  9. Walk test the detector.

Figure 1

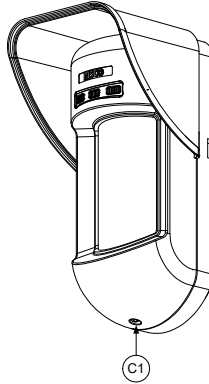

Figure 2

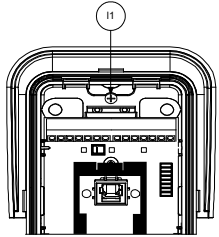

Figure 3

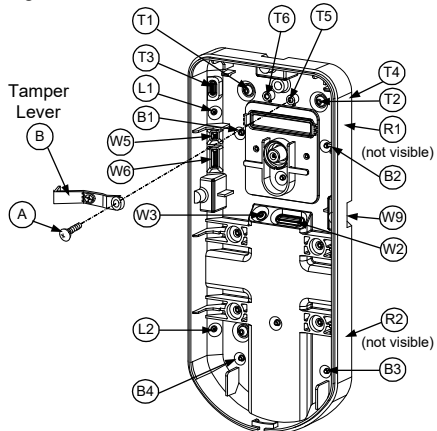
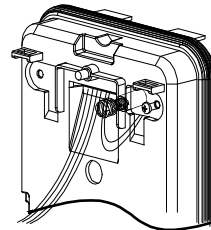

Figure 4



### Note:

For 45° right side installation use the equivalent units on the external base as follows:

Knockouts Description	Left	Right
Mounting Knockouts	L1, L2	R1, R2
Tamper spring knockouts	T1, T3	T2, T4
Tamper screw anchor	T5	T6
Wiring Knockouts	W5, W6	W7, W8

## Changing Back Tamper position

The back tamper is by default secured on the right side of the internal base (rear view). If you wish to move it to the left side (rear view), do the following (Figure 5):

1. Remove tamper screw 1 in order to release the tamper from position 7.
2. Ensure tamper spring 2 rests over tamper wire base 4.
3. Ensure plastic tamper bracket 3 rests over both 2 and 4.
4. Secure tamper screw 1 into 3 over position 6.

Figure 5

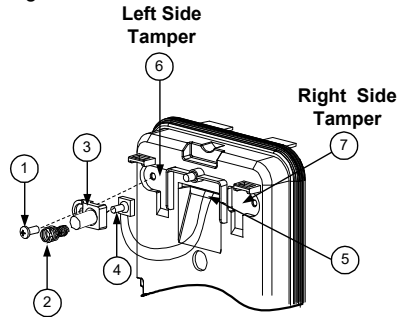

### Notes:

1. Verify that you hear a "Click" when attaching the tamper spring to the wall.
2. For pole installation, the tamper can be moved to the bottom right-hand side of the internal base.

## Terminal Wiring

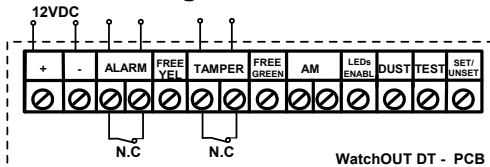

<b>+,-</b>	12 VDC												
<b>ALARM</b>	N.C relay, 24VDC , 0.1A												
<b>FREE YEL</b>	This terminal is a free pin that can be used to connect wires and EOL resistors												
<b>TAMPER</b>	N.C switch, 24VDC , 0.1A												
<b>FREE GREEN</b>	This terminal is a free pin that can be used to connect wires and EOL resistors												
<b>AM</b>	Normally closed AM relay output (24VDC, 0.1A) indicates Anti Masking alarm or any trouble in the detector (not including dust/dirty lens). The Proximity AM enables receiving sabotage alerts before the detector is damaged or masked, using both microwave channels. <b>Note:</b> Proximity AM: When DIP8 is defined as Enabled, this relay also opens when a Proximity AM attempt occurs. In this case, the relay will remain open for at least 20 seconds and will be closed following movement detection.												
<b>LED ENABLE</b>	Used to remotely control the LEDs when <b>DIP1</b> is set to ON. Enable: input is +12V OR no terminal connection Disable: Connect the input to 0V												
<b>DUST</b>	N/A												
<b>TEST</b>	Used to perform remote alarm testing to the detector by applying 0 volts to this terminal. Success: Alarm relay is momentary opened. Failure: AM relay is opened												
<b>SET/ UNSET</b>	This input enables to control Anti-masking and LEDs operation in accordance to the system status, Set (Arm) / Unset (Disarm). While the system is armed this feature prevents an intruder from gaining knowledge of the detector's status and disables Anti-masking detection. <table border="1"> <thead> <tr> <th>System Status</th> <th>Input Status</th> <th>AM Relay</th> <th>LEDs</th> </tr> </thead> <tbody> <tr> <td>Set (Arm)</td> <td>0V</td> <td>Off</td> <td>Off</td> </tr> <tr> <td>Unset (Disarm)</td> <td>12V or no connection</td> <td>On*</td> <td>On**</td> </tr> </tbody> </table> * DIP7 is ON (Anti masking enabled) ** DIP1 is ON (LEDs enabled) and LEDs ENABLE input terminal is enabled (+12V OR no terminal connection).	System Status	Input Status	AM Relay	LEDs	Set (Arm)	0V	Off	Off	Unset (Disarm)	12V or no connection	On*	On**
System Status	Input Status	AM Relay	LEDs										
Set (Arm)	0V	Off	Off										
Unset (Disarm)	12V or no connection	On*	On**										

## DIP Switch Settings

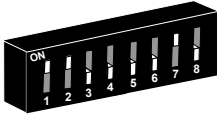

### Factory Defaults

#### DIP 1: LEDs operation

- On: LEDs Enabled
- Off: LEDs Disabled

#### DIP 2-3: Detection Sensitivity

Sensitivity	DIP2	DIP3
Low	Off	Off
Mid	Off	On
Normal (Default)	On	Off
Maximum*	On	On

\* In maximum sensitivity sway recognition is disabled to achieve maximum sensitivity

#### DIP 4: Anti masking Sensitivity

- On: High
- Off: Low

#### DIP 5: Detector's optics

- On: Barrier / Long range
- Off: Wide angle

#### DIP 6: Red LED /3 LED

- On: Red LED only
- Off: 3 LEDs

#### DIP 7: Anti masking operation

- On: Enabled
- Off: Disabled

#### DIP 8: Proximity AM

- On: Enabled
- Off: Disabled

## Microwave Adjustment

Adjust Microwave coverage area by using the trimmer on the PCB.



## Walk test

Two minutes after applying power, walk test the protected area to verify proper operation.

For installations on uneven surfaces slide the PCB inside the internal base to the appropriate setting according to the desired height (1.0m, 1.5m, 2.2m, 2.7m) as printed on the bottom left corner of the PCB or use the standard swivel accessory.

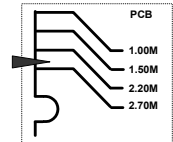

**For reducing the detection range, slide the PCB up or tilt the swivel down.**

## LEDs Display

LED	State	Description
YELLOW	Steady	Indicates PIR detection
	Flashing	Indicates Active IR AM (Anti mask) detection
GREEN	Steady	Indicates MW detection
	Flashing	Indicates Proximity AM detection
RED	Steady	Indicates ALARM
	Flashing	Indicates malfunctioned communication with ProSYS (BUS mode only)
All LEDs	Flashing (One after another)	Unit initialization on power up

### Notes:

1. DIP-Switch 1 should be in ON position to enable LED indications.
2. Only one LED is active at any one time. For example, in the case of both PIR and MW detection, either the steady YELLOW LED or the steady GREEN LED is displayed (the first to detect), followed by the Alarm RED
3. In order to prevent the analysis of detection technologies such as PIR, Microwave, Active IR AM and Proximity AM, set DIP Switch 6 (SW1) to ON. Only the red LED will be activated.

## Relay Mode / BUS Mode Jumper

J-BUS jumper (located on the PCB between the red and green LEDs) is used to define the detector's mode of operation as follows:

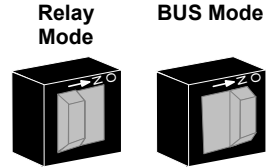

## Standard Swivel Installation

The Outdoor detector packaging contains a standard swivel for flexible installation. Please follow the instructions below for mounting the detector with the Standard Swivel:

1. Open WatchOUT front cover (Unlock C1, Figure 1).
2. Release internal base (Unlock I1, Figure 2).
3. Open knockouts on external base (Figure 6, Detail B)
  - W1: Wires knockout
  - S1,S2: Knockouts for securing external base to Standard Swivel
  - S3: External base locking screw knockout
4. On the swivel accessory remove the required swivel cable wiring knockout S2, S7 or S9 (Figure 6, Detail A).
5. Remove back tamper from the internal base (see "Changing Back Tamper Position" paragraph) and connect it to S5 (Figure 6, Detail A) on the Standard Swivel.

### Note:

Ensure that you see the engraved **UP** mark on the upper front face of the swivel.

6. Select the mounting installation type as follows:

### Wall Mounting

- a. Insert external cable wiring through knockouts S2, S7 or S9 and extract them (including the tamper wires) through the Swivel Wires Passage (Figure 6, Detail B).
- b. Secure swivel to the wall through holes S1, S3, S6 and S8.

### Swivel Conduit Mounting (using Conduit Metal Swivel Adaptor – CSMA, Figure 6, Detail A)

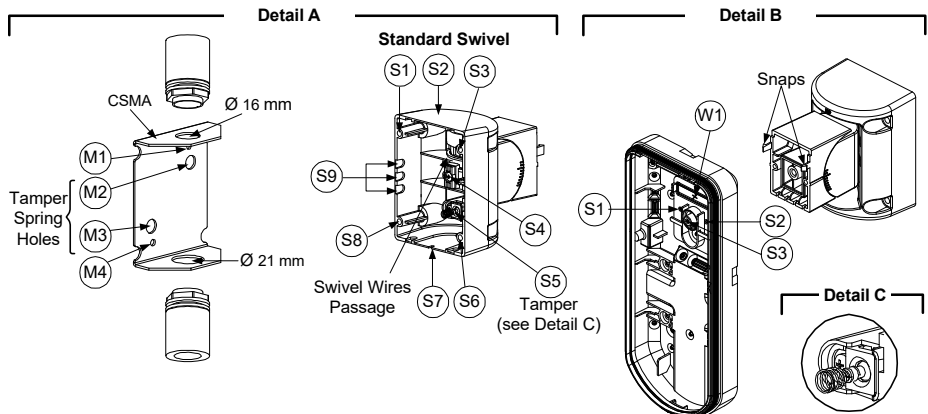

Figure 6

### Note:

The CSMA is required when wall external wiring is used and protection pipe is required. The CSMA should be ordered separately - P/N RA300SC0000A.

- a. Choose the direction upon which to mount the CSMA according to the required diameter: 16mm (0.63 inches) or 21mm (0.83 inches).
- b. Insert conduit to the CSMA.



- c. Secure CSMA to the wall through points (M1, M4).
- d. Insert external cables and tamper wires from the conduit through the swivel wires passage of the swivel (Figure 6, Detail A).
- e. Secure swivel to the wall through holes S1, S3, S6 and S8.

**Note:**

The Tamper spring S5 (Figure 7) should make contact with the wall through the tamper spring holes M2 or M3 on the CSMA. Make sure to hear the tamper "Click" when connecting to the wall.

7. Insert tamper wires and external cable wiring from Standard Swivel through knockout W1 on the external base (Figure 6, Detail B).
8. Connect the external base to the swivel using the dedicated snaps (Figure 7).

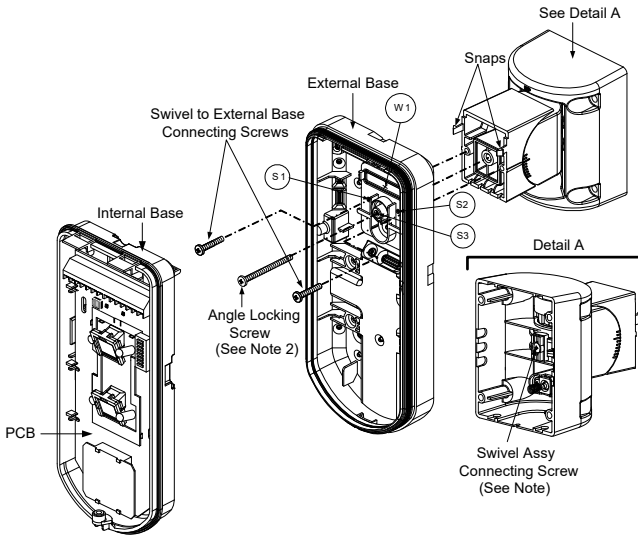

Figure 7

**Note:**

Do not open or close the Swivel Assy Screw since it is used for connecting the swivel parts only.

9. Secure external base to swivel with two screws fastened to knockouts S1 and S2 (Figure 7).
10. Insert the supplied angle locking screw from the external base through the angle locking screw knockout S3 on the external base to the standard swivel (Figure 7).
11. Tilt and Rotate the Standard Swivel to the desired position. Once the Standard Swivel is in the desired position, secure the angle locking screw.
12. Line up the internal base onto the external base. Insert all wiring cables through the internal base.
13. Secure internal base to external base (Lock I1, Figure 2).
14. To readjust the Standard Swivel when the PCB is installed (Figure 7):
  - a. Bend down the black foam located below the RED LED on the PCB (enough to reach the Swivel locking screw).
  - b. Use a Philips screwdriver to release the locking screw (see Figure 8).
  - c. Tilt and/or Rotate the Standard Swivel to the desired position.
  - d. Secure the angle locking screw.

**Note:**

When marks on the two movable parts are aligned (Figure 8), the Standard Swivel is in 0° vertical /horizontal position. Each click from this position represents shifting of 5° in vertical / horizontal position.

15. Close the front cover (Lock C1, Figure 1) and walk test the detector.

**Note:**

The screw has to pass through External Base and locked to the swivel.

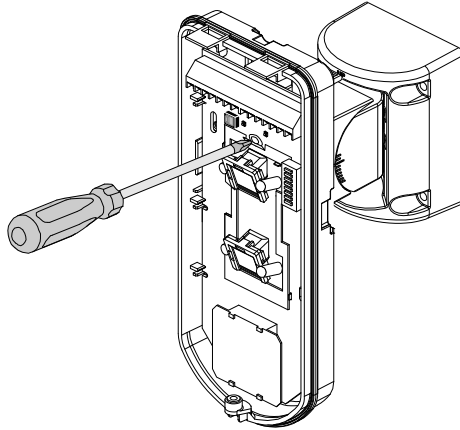
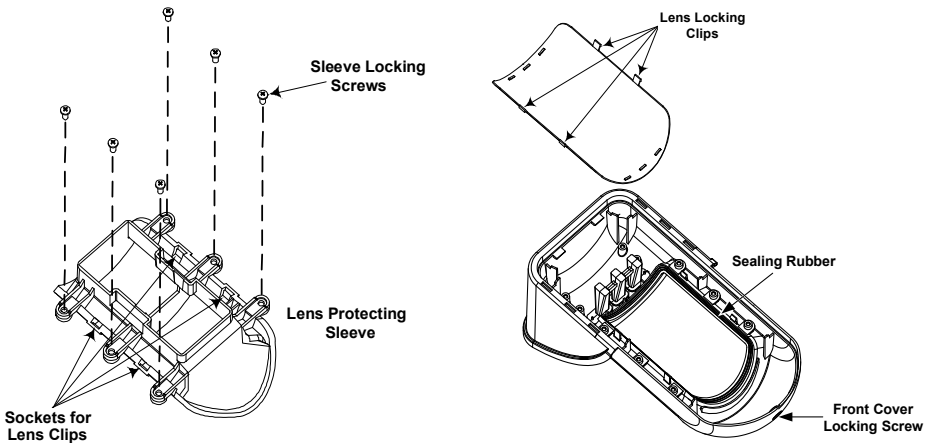

Figure 8

## Replacing Lenses

1. Unlock the six screws that hold the lens holding sleeve from the back of the front cover.
2. To release the protective sleeve, gently push the lens from the external side of the front cover.
3. Disconnect the lens from the sleeve by gently pushing the lens clips that secure it to the sleeve.
4. Replace the lens. Place the 4 clips of the lens into the matching holes on the sleeve.
5. Insert the protective sleeve back into place on the front cover. Pay attention to place the sleeve over the sealing rubber.
6. Secure the 6 holding screws back to their place.



Lens Types

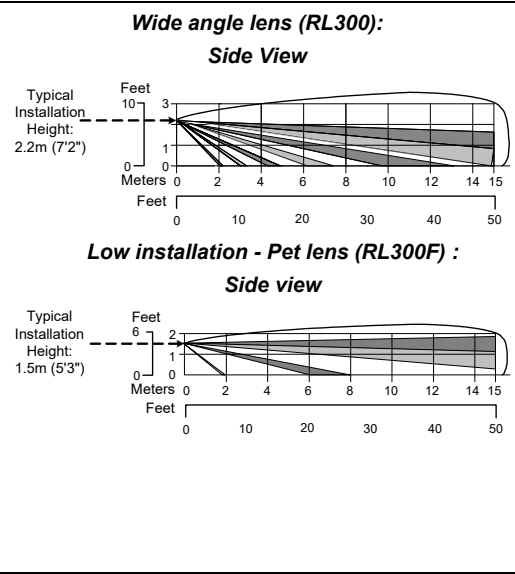
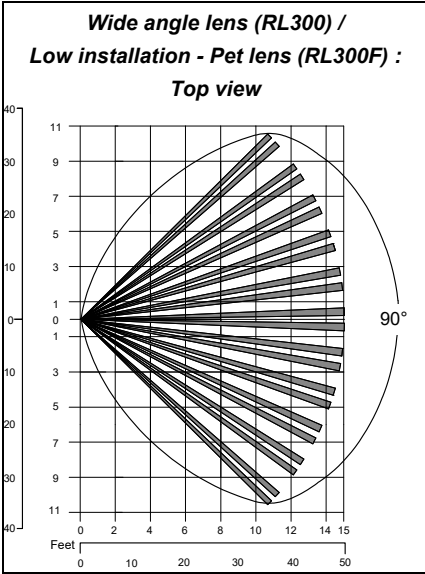

**Note:**

The detector's Pet Immunity (height of an animal, no weight limitation), is up to 70 cm (2'4"), when installing the detector at 2.2m (7'2"). If the installation is below the height mentioned above, the Pet Immunity decreases accordingly; every 10 cm (4") decrease in installation height leads to 10 cm (4") decrease in pet immunity.

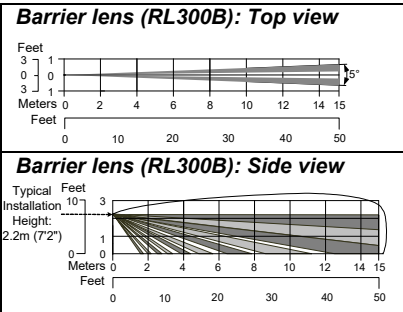
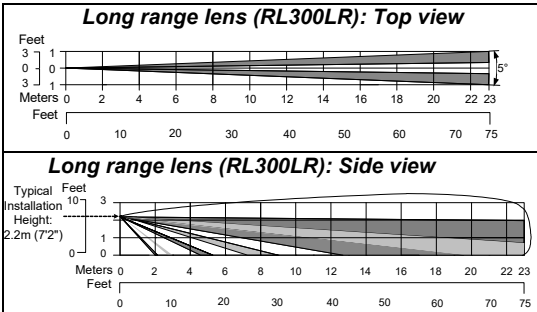

## Technical Specification

Electrical	
Current consumption	30mA at 12 VDC (Stand by)
	42mA at 12 VDC (MAX with LED ON)
Voltage requirements	9 -16 VDC
Alarm contacts	24 VDC, 0.1A
AM contacts	24 VDC, 0.1A
Dust output	Open collector 70mA max
Power Output	10.587GHZ: 10dbm Typ.
Frequency	10.587GHZ
Physical	
Size: LxWxD	230 x 123 x 124mm (9 x 4.8 x 4.88 in.)
Weight	0.632 Kg (1.4lb)
Environmental	
RF immunity	According to EN50130-4
Operating/Storage temperature	-30°C to 60°C (-22°F to 140°F)

\* PIR technology is limited in rough environmental conditions.

## Ordering Information

### Standard Units

Model	Description
WatchOUT 315DT	WatchOUT DT + Swivel
<b>Note:</b>	
Each of the detectors contains a standard swivel and 3 replacement lenses (P/N engraved on the Lens) 1.7m low installation pet (RL300F), long-range (RL300R) and barrier lens (RL300B).	

### Accessories Kits

Model	Description	Weight
RA300B	WatchOUT Barrier Swivel Kit	0.1 Kg (0.23 lb)
RA300P	WatchOUT Pole Adaptor Kit	0.25 Kg (0.55 lb)
RA300C	WatchOUT Conduit Adaptor Kit	0.6 Kg (1.27 lb)
RA300HS	WatchOUT Demo Housing	- -
RA300SC	WatchOUT Swivel Metal Conduit Adaptor	1Kg (2.2 lb)

### Camera Option

Model	Description
WatchOUT VC1	WatchOUT Camera Cover Adaptor
WatchOUT VC017	WatchOUT Narrow Camera
WatchOUT VC053	WatchOUT Wide Camera
WatchOUT VCPS	WatchOUT Camera 220V Power Supply
WatchOUT VCPS	WatchOUT Camera 120V Power Supply

## UL Compliance Section

To comply with UL, note the following:

- ◆ The unit is intended for outdoor installation where unwanted alarms are tolerable. If not, it is recommended to connect it to the trouble circuit of a listed compatible control unit.
- ◆ A dead zone of 5 ft should be considered during installation.
- ◆ The camera option is not UL listed.
- ◆ **Disclaimer:** PET feature has not been tested or verified by UL.
- ◆ 0.6 power factor inductive load can be used on the relays.
- ◆ Relay mode is intended to be connected to listed compatible control unit or power supply that provides 4 hours of standby power.
- ◆ It may be necessary to set detector at maximum sensitivity to achieve maximum distance.
- ◆ Do not connect the DUST output to a UL listed product.
- ◆ When the detectors are connected to the BUS of the ProSYS panel, the detectors are to be powered from either the ProSYS (Version 7.55) panel or a listed compatible burglar alarm power supply that has an output voltage range that does not exceed 9-16 vdc, has a minimum of 4 hrs. of standby power, and is suitable for mercantile use.



*Only P/N:  
RK315DT00USB  
is UL approved*

# BUS Mode Installation

## Introduction

The information in this section relates to WatchOUT 315DT installation in BUS Mode only. Up to 32 BUS detectors can be installed on the ProSYS RS485 BUS, saving cabling time and enabling remote control and diagnostics.

## Terminal Wiring

<b>+,-</b>	Used for the connection of 12VDC power supply. Connect the (+) terminal to the AUX RED and the (-) terminal to the COM BLK of the ProSYS terminals
<b>YELLOW</b>	Used for data communication with the ProSYS. Connect to the terminal to the <b>BUS YEL</b> of the ProSYS
<b>GREEN</b>	Used for data communication with the ProSYS. Connect to the terminal to the <b>BUS GRN</b> of the ProSYS
<b>TAMPER</b>	Used for the wiring for tamper detection, see below
<b>LED ENABLE</b>	Used for the wiring for tamper detection, see below
<b>Note:</b>	
All terminals that are not mentioned in the table above are unused.	

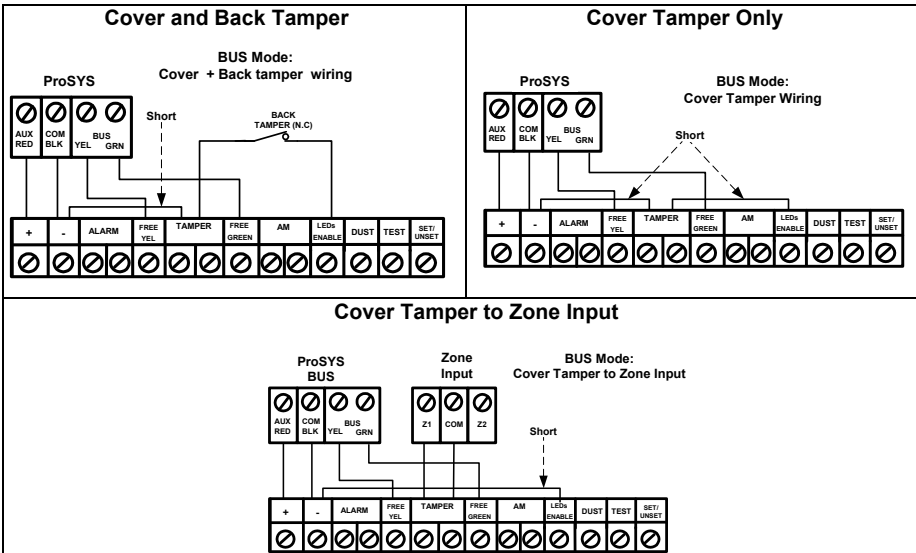

## DIP Switch Settings

DIP Switch Number	Description
1 - 5	Used to set the detector ID number. Set the ID number in the same way as for any other ProSYS accessory (Refer to the ProSYS installation instruction manual)
6 - 8	Not used

## WatchOUT ID: DIP Switches 1 - 5

ID	1	2	3	4	5
01	OFF	OFF	OFF	OFF	OFF
02	ON	OFF	OFF	OFF	OFF
03	OFF	ON	OFF	OFF	OFF
04	ON	ON	OFF	OFF	OFF
05	OFF	OFF	ON	OFF	OFF
06	ON	OFF	ON	OFF	OFF
07	OFF	ON	ON	OFF	OFF
08	ON	ON	ON	OFF	OFF
09	OFF	OFF	OFF	ON	OFF
10	ON	OFF	OFF	ON	OFF
11	OFF	ON	OFF	ON	OFF
12	ON	ON	OFF	ON	OFF
13	OFF	OFF	ON	ON	OFF
14	ON	OFF	ON	ON	OFF
15	OFF	ON	ON	ON	OFF
16	ON	ON	ON	ON	OFF

ID	1	2	3	4	5
17	OFF	OFF	OFF	OFF	ON
18	ON	OFF	OFF	OFF	ON
19	OFF	ON	OFF	OFF	ON
20	ON	ON	OFF	OFF	ON
21	OFF	OFF	ON	OFF	ON
22	ON	OFF	ON	OFF	ON
23	OFF	ON	ON	OFF	ON
24	ON	ON	ON	OFF	ON
25	OFF	OFF	OFF	ON	ON
26	ON	OFF	OFF	ON	ON
27	OFF	ON	OFF	ON	ON
28	ON	ON	OFF	ON	ON
29	OFF	OFF	ON	ON	ON
30	ON	OFF	ON	ON	ON
31	OFF	ON	ON	ON	ON
32	ON	ON	ON	ON	ON

## ProSYS Programming

The following section describes the additional software programming options, added to the ProSYS software, that concern the settings of the WatchOUT DT as a BUS detector. Up to 32 BUS detectors can be added to the system (16 in ProSYS 16) and each of them comes at the expense of a zone in the system.

It is recommended reading and fully understanding the ProSYS Installation and User Manuals, before programming the WatchOUT.

### Notes:

The WatchOUT is compatible with the ProSYS software Version 4.xx and above.

The WatchOUT can be programmed via the U/D Software from UD Version 1.8 and above.

For maximum operation stability, it is best NOT to exceed a total of 300 meters (1000 feet) of wiring when connecting the WatchOUT to the BUS.

### Adding / Deleting the WatchOUT DT

The WatchOUT is part of a new accessory category, BUS zones. Therefore, Adding/Deleting the WatchOUT is identical to any other accessory with the following exception:

**Each BUS Zone Detector should be assigned to a Regular Zone.**

Any BUS detector can be assigned to a physical wired zone or to a virtual zone.

**Physical zone:** Any zone on the ProSYS PCB (zones 1-8) or on a wired zone expander (ZE08, ZE16).

**Virtual zone:** Any zone on a BUS zone expander defined as BZ08 or BZ16.





### Notes:

Virtual BUS zones are cost effective. They enable to expand your system zones without adding physical zone expanders.

The virtual BUS zone expander can be used only for BUS zone detectors.





To add a BUS zone expander select type BZ08 or BZ16 when adding a zone expander (Quick key [7][1][2]).

### 1. To Add / Delete the WatchOUT DT

- From the installer menu enter the Add/Delete menu: Quick Key [7][1][9][5] for BUS Zones detectors.
- Use the  /  or  /  keys to position the cursor over the BUS Zone ID number for which you want to assign (or delete) a detector.

### Note:

Make sure that the detector's physical ID number is identical to the ID number you select during programming.



- Place the cursor on the TYPE field and use the  /  key to select ODT15 for the WatchOUT DT detector.
- Press  /  to confirm.
- Repeat the process for the other BUS detectors.

## 2. Assigning the WatchOUT DT to a Zone



- From the main installer menu enter Zones: One by One option (Quick key **[2][1]**)
- Select the zone number that you want to assign the BUS detector.

### Note:

If you defined a BUS Zone Expander, select a zone number from the virtual zones (defined by the BUS zone expander).

- Define Partitions, Groups, Zone Type and Zone Sound.
  - In the Termination category select [5] BUS Zone followed by  / .
- The following display appears:

```
Z:001   LINK TO:
ID:01   TYPE=ODT15
```

- Select the BUS zone number to assign to the programmed zone. The type field will be updated automatically when selecting the zone.
- Press  / . The loop response category is not applicable to a BUS zone and the following display appears:



```
Z:001   RESPONSE:
N/A-BUS ZONE
```

- Press  / , assign label and press  / .

## 3. Configuring the WatchOUT DT Parameters

- To access the WatchOUT settings option press **[2][0][3]** from the main installer menu. The following display appears:

```
B-ZONE PRMS:
ZONE#=001   (M:ZZ)
```

- Select the zone that the BUS zone was assigned to and press  / . You can now program the WatchOUT parameters as follows:

### Zones Miscellaneous: BUS Zone

Quick Keys	Parameter	Default
<b>[2][0][3][zzz][1]</b>	<b>LEDS</b> Defines the LEDES operation mode.	<b>3 LEDES</b>
<b>[2][0][3][zzz][1][1]</b>	<b>Off</b> Disables the LEDES operation.	
<b>[2][0][3][zzz][1][2]</b>	<b>Red Only</b> Only the Red led will operate. This option is highly recommended to avoid the possibility that the intruder will "Learn" the detector behavior.	
<b>[2][0][3][zzz][1][3]</b>	<b>3 LEDES</b> All 3 LEDs will operate.	
<b>[2][0][3][zzz][2]</b>	<b>PIR Sensitivity</b> Defines the sensitivity of the detector(MW + PIR)	<b>Normal</b>
<b>[2][0][3][zzz][2][1]..[4]</b>	<b>Sensitivity Options</b> 1) Low                      3) Normal 2) Medium                 4) High	
<b>[2][0][3][zzz][3]</b>	<b>MW Range</b> Defines the microwave channel range. The maximum is 23m.	<b>Trimmer</b>



Quick Keys	Parameter	Default
[2][0][3][zzz] [3][1]..[7]	<b>MW Range options</b>	
	1) Minimum      3) 40%      5) 80%      7) Trimmer (MW is defined by the trimmer setting on the PCB) 2) 20%      4) 60%      6) Maximum	
[2][0][3][zzz] [4]	<b>Anti-Mask sensitivity</b>	<b>Low sensitivity</b>
	Defines the sensitivity of the active IR AM	
[2][0][3][zzz] [4][1]..[2]	<b>Anti-Mask sensitivity option</b>	
	1) Low Sensitivity   2) High Sensitivity	
[2][0][3][zzz] [5]	<b>Lens Type</b>	<b>Wide Angle</b>
	Defines the actual Lens of the detector	
[2][0][3][zzz] [5][1]..[2]	<b>Lens Type Options</b>	
	1) Wide Angle   2) Barrier / Long Range	
[2][0][3][zzz] [6]	<b>Anti-Mask</b>	<b>Enable</b>
	Defines the operation of Anti Masking detection	
[2][0][3][zzz] [6][1]..[2]	<b>Anti-Mask Options</b>	
	1) Disable   2) Enable (Default)	
[2][0][3][zzz] [7]	<b>Arm/Disarm</b>	<b>No</b>
	Defines the operation of the LEDs anti masking detections while the detector is armed	
[2][0][3][zzz] [7][1]	<b>No</b>	
	Active IR AM and Proximity AM (Anti masking) is enabled LEDs behave according to the LEDs parameter definition	
[2][0][3][zzz] [7][2]	<b>Yes</b>	
	Active IR AM and Proximity AM (Anti masking) is disabled LEDs are disabled	
[2][0][3][zzz] [8]	<b>Proximity AM</b>	<b>Disable</b>
	Defines the operation of the Proximity Anti Masking detection	
[2][0][3][zzz] [8][1]..[2]	<b>Proximity AM Options</b>	
	1) Disable (Default)   2) Enable <b>NOTE:</b> Disable Proximity AM during heavy rain (if WatchOUT 315DT is not sheltered) to prevent Proximity AM alerts.	









## System Parameters

### System: System Control

Quick Keys	Parameter	Default:
[1][2][36]	<b>IR AM=Tamper</b>	<b>No</b>
	Used to determine the operation of Active IR Anti Masking detection <b>Yes:</b> Active IR Anti mask detection will activate tamper alarm. <b>No:</b> Active IR Anti mask detection will be regarded as trouble event.	
[1][2][37]	<b>Prox AM=Tamper</b>	<b>No</b>
	Used to determine the operation of the Proximity Anti Masking detection <b>Yes:</b> Proximity Anti mask detection will activate tamper alarm. <b>No:</b> Proximity Anti mask detection will be regarded as a trouble event.	

## Diagnostics

The ProSYS enables you to test parameters that reflect the operation of the detector.

1. From the main user menu press  [4] to access the Maintenance menu.
2. Enter the Installer code (or sub-installer) and press  / .
3. Press [9] [1] to for the BUS Zones diagnostic menu.
4. Enter the digit of the zone that you want to test and then press  / . The system will perform the diagnostics test and a list of test parameters will appear, as indicated in the table below.
5. Use the keys  /   /  to view the diagnostics test results.

**User Menu: 4) Maintenance → 9) Diagnostic → 1) BUS Zone**

Quick Keys	Parameter
[4][9][1][zzz]	<p><b>Detector Input Voltage:</b> Display the input voltage of the detector.</p> <p><b>PIR 1 Level:</b> PIR channel 1 DC level. Range 0.1v - 4v</p> <p><b>PIR 1 Noise Level:</b> PIR channel 1 AC level. Range 0VAC (No noise) - 4VA</p> <p><b>PIR 2 Level:</b> PIR channel 2 DC level. Range 0.1v - 4v</p> <p><b>PIR 2 Noise Level:</b> PIR channel 2 AC level. Range 0VAC (No noise) - 4VA</p> <p><b>MW 1 Level:</b> MW channel 1 DC level Range 0.1v - 4v</p> <p><b>MW 1 Noise Level:</b> MW channel 1 AC level (0VAC (No noise) - 4VAC)</p> <p><b>MW 2 Level:</b> MW channel 2 DC level Range 0.1v - 4v</p> <p><b>MW 2 Noise Level:</b> MW channel 2 AC level (0VAC (No noise) - 4VAC)</p>

# Indice Dei Contenuti

<b>Installazione in modalità relé .....</b>	<b>20</b>
<b>Introduzione .....</b>	<b>20</b>
<b>Installazione.....</b>	<b>20</b>
Considerazioni per l'installazione .....	20
Installazione a parete.....	21
Installazione piana .....	21
Installazione angolare di 45° (installazione a sinistra).....	21
Modifica della posizione del tamper antirimozione .....	22
<b>Cablaggio morsettiera.....</b>	<b>22</b>
<b>Predisposizione Microinterruttori .....</b>	<b>23</b>
<b>Regolazione microonda.....</b>	<b>23</b>
Prova di movimento .....	23
<b>Indicatori LED.....</b>	<b>24</b>
<b>Microinterruttore Modalità Relé / BUS .....</b>	<b>24</b>
<b>Installazione dello snodo standard .....</b>	<b>24</b>
Installazione a parete.....	24
Installazione per tubo elettrico.....	25
<b>Sostituzione delle Lenti .....</b>	<b>27</b>
Tipologie di Lenti.....	28
<b>Caratteristiche Tecniche .....</b>	<b>29</b>
<b>Informazioni per l'ordine.....</b>	<b>29</b>
<b>Installazione in modalità BUS .....</b>	<b>30</b>
<b>Introduzione .....</b>	<b>30</b>
<b>Cablaggio morsettiera.....</b>	<b>30</b>
<i>Tamper Antiapertura e Antirimozione .....</i>	<i>30</i>
<i>Solo Tamper Antiapertura .....</i>	<i>30</i>
<i>Tamper Antiapertura ad un Ingresso di Zona .....</i>	<i>30</i>
<b>Predisposizione microinterruttori .....</b>	<b>31</b>
<b>Programmazione ProSYS.....</b>	<b>31</b>
Aggiunta e Cancellazione del WatchOUT DT .....	31
Configurazione dei parametri del WatchOUT DT .....	32
<b>Parametri di Sistema.....</b>	<b>33</b>

# Installazione in modalità relé

## Introduzione

Il rivelatore da esterno Doppia Tecnologia WatchOUT 315DT di RISCO Group è un dispositivo a microprocessore che elabora i segnali rilevati tramite due canali all'infrarosso passivo (PIR) e due canali a microonda (MW). Il rivelatore può funzionare come rivelatore tradizionale con uscite a relé collegabili a qualsiasi centrale d'allarme, o come rivelatore indirizzato via BUS 485 collegato ai sistemi ProSYS di RISCO. Quando viene collegato ai sistemi ProSYS, il rivelatore può essere programmato e testato sia localmente che in remoto tramite tastiere LCD ProSYS e/o software di Teleassistenza RISCO. Le istruzioni che seguono descrivono l'installazione e la configurazione del WatchOUT 315DT sia in modalità Relé che via BUS. Per informazioni sul collegamento in modalità BUS ProSYS, consultare il capitolo "Installazione in modalità BUS".

## Installazione

### Considerazioni per l'installazione

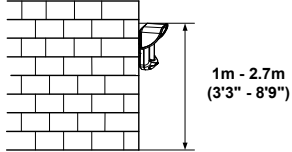
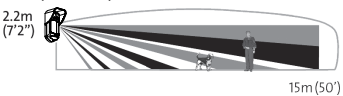
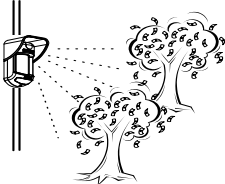
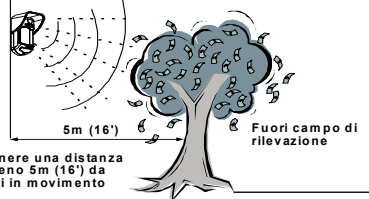
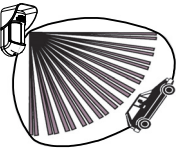
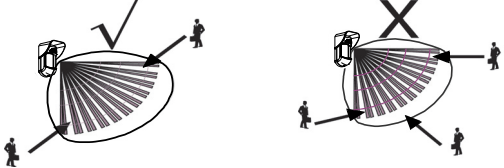
 <p>Altezza di installazione: Grandangolo 15m 90° (RL300)</p> 	 <p>Se possibile, evitare di direzionare l'unità verso oggetti in movimento (alberi ondeggianti, cespugli, ecc.)</p>
<p><b>Note:</b></p> <ol style="list-style-type: none"><li>1. Per altezze di installazione basse, al di sotto di 1.7m ove è richiesta l'opzione di discriminazione animali, vanno utilizzate le lenti RL300F (muri bassi o installazione su recinzioni).</li><li>2. La discriminazione animali (altezza dell'animale senza limiti di peso) arriva fino a 70 cm con il rivelatore installato a 2.2m. Se l'altezza di installazione è al di sotto di 2.2 metri la discriminazione animali si riduce proporzionalmente. Ogni 10cm in meno rispetto a 2.2 metri corrispondono 10 cm in meno di altezza dell'animale discriminato.</li></ol>	 <p>Mantenere una distanza di almeno 5m (16') da oggetti in movimento</p> <p>Fuori campo di rilevazione</p> <p>Assicurarsi che nessun oggetto ostruisca il campo di rilevazione dell'unità sia per la sezione a microonda sia per quella ad infrarossi. Prestare attenzione alla crescita di alberi, rami e ad eventuali altre piante che con il tempo possono coprire l'area di rilevazione.</p>
<p>Per quelle installazioni vicino a strade ad intenso traffico di veicoli o oggetti oltre l'area di rilevazione desiderata, si consiglia di regolare la sensibilità della microonda (MW) e/o inclinare il rivelatore verso il basso.</p> <p><b>Nota:</b></p> <p>Inclinando il rivelatore verso il basso è possibile che la funzione di immunità agli animali si riduca.</p>	
<p>Per una migliore rivelazione selezionare una posizione di installazione in modo che l'eventuale intruso attraversi l'area di copertura del rivelatore con una traiettoria di circa 45° rispetto allo stesso.</p>	
<p><b>NOTA:</b> Con la funzione 'Antiavvicinamento' abilitata e il sensore installato a cielo aperto, si raccomanda di creare un riparo sopra di esso per evitare allarmi impropri in presenza di forti piogge o alternativamente disabilitare la funzione.</p>	

## Installazione a parete

### Nota:

I numeri di riferimento dei fori a sfondare per l'installazione sono marcati sulla base posteriore.

1. Aprire il coperchio frontale del WatchOUT.  
(Svitare C1, figura 1).
2. Sganciare la base interna (svitare I1, fig. 2).
3. Selezionare l'altezza di installazione come segue:

### Installazione piana

Aprire i fori a sfondare della base esterna (fig. 3)

- B1 - B4: Fori a sfondare per installazione a parete.
- T1: Foro a sfondare per il tamper antirimozione
- W2 / W3: Fori a sfondare per il passaggio cavi

### Installazione angolare di 45° (installazione a sinistra)

- Aprire i fori a sfondare della base esterna (fig. 3)
  - L1, L2 : Fori a sfondare per lato sinistro
  - T3: Foro a sfondare per tamper lato sinistro
  - W5 / W6: Fori a sfondare per passaggio cavi
- Rimuovere la molla del tamper
- Sostituire la staffa (Item 1) con l'altra fornita (Item 2).

Item 1



Item 2



- Inserire la leva B del tamper in T5 e T3 e stringere la vite A (figura 3)
4. Inserire i cavi esterni attraverso la base esterna W2, W3 (Installazione piana) o W5, W6 (Installazione a sinistra) (figura 3).
  5. Fissare la base esterna alla parete.
  6. Inserire i cavi esterni e i cavi del tamper attraverso la base interna. (figura 4).
  7. Fissare la base interna a quella esterna (bloccare I1, figura 2).
  8. Chiudere il coperchio frontale (bloccare C1, figura 1) dopo aver cablato l'unità e predisposto i microinterruttori.
  9. Effettuare le prove di copertura.

Figura 1



Figura 2



Figura 3

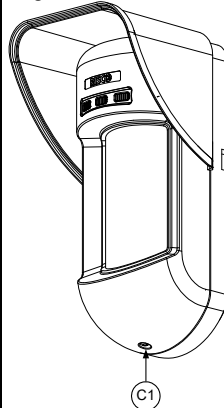

Figura 4

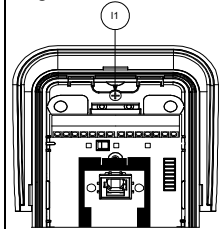

<b>Nota:</b>		
Per installazioni a 45° lato destro usare le equivalenti predisposizioni sulla base esterna come segue:		
<b>Descrizione fori a sfondare</b>	<b>Sinistra</b>	<b>Destra</b>
Fori a sfondare per il fissaggio della base	L1, L2	R1, R2
Foro a sfondare per la molla del tamper	T1,T3	T2,T4
Punto di fissaggio vite tamper	T5	T6
Fori a sfondare per passaggio cavi	W5, W6	W7, W8

### Modifica della posizione del tamper antirimozione

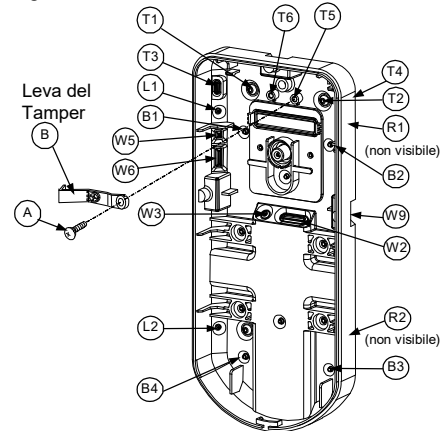
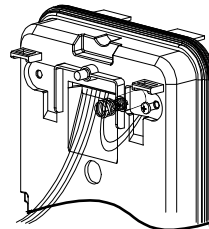
Di fabbrica il tamper antirimozione è fissato sul lato destro della base interna (Vista Posteriore). Se si desidera spostarlo nella parte sinistra, procedere come segue (figura 5):

1. Svitare la vite tamper 1 per rimuoverlo dalla posiz. 7.
2. Assicurarsi che la molla 2 del tamper resti posizionata sulla base 4 del tamper.
3. Assicurarsi che la staffa 3 del tamper resti tra 2 e 4.
4. Fissare la vite 1 del tamper in 3 sulla predisposizione 6.

Figura 5

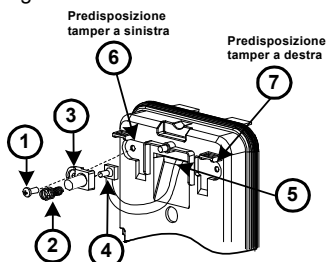

### Nota:

1. Verificare che si senta un "Click" quando la molla del tamper viene spinta contro il muro.
2. Per l'installazione su palo il tamper può essere spostato nella parte inferiore destra della base interna.

### Cablaggio morsetti

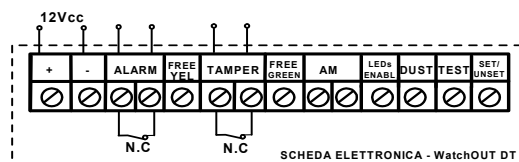

<b>+, -</b>	12 Vcc
<b>ALARM</b>	Relé N.C. 24Vcc, 0.1A
<b>FREE YEL</b>	Questo è un morsetto libero per il posizionamento di cavi o resistenze di fine linea.
<b>TAMPER</b>	Relé N.C. 24Vcc, 0.1A
<b>FREE GREEN</b>	Questo morsetto è un morsetto libero per il posizionamento di cavi o resistenze di fine linea.
<b>AM</b>	L'uscita a relé N.C. (24Vcc; 0,1A) dell'AM, se attiva indica una condizione di Mascheramento o una qualsiasi anomalia del rivelatore (questa uscita NON segnala l'anomalia "Lenti Sporche"). L'antiprossimità permette di ricevere un segnale di allarme utilizzando entrambi i canali microonda, prima che il rivelatore venga manomesso o mascherato. <b>Nota:</b> Se il microinterruttore DIP8 è in ON, questo relé si attiva anche momentaneamente per almeno 20 secondi alla rilevazione dell'avvicinamento gestito dal circuito di anti-prossimità.
<b>LED ENABLE</b>	Ingresso usato per controllare da remoto i LED quando il <b>microint. 1</b> è in ON. LED abilitati: Tensione +12V presente o morsetto non connesso LED disabilitati: 0V presente all'ingresso
<b>DUST</b>	Non Applicabile.

<b>TEST</b>	Usato per testare il rivelatore da remoto applicando 0V a questo morsetto. Test OK: Il relé di allarme si attiva per qualche secondo. Guasto: L'uscita AM viene attivata.		
<b>SET/ UNSET</b>	Questo ingresso permette di abilitare o disabilitare l'antimascheramento e l'accensione dei LED quando il sistema è inserito (Set) o disinserito (Unset). A sistema inserito questa funzione disabilita i LED (evitando che un intruso possa verificare che il sistema ha generato un allarme) e l'antimascheramento.		
	<b>Stato del sistema</b>	<b>Stato ingresso</b>	<b>Uscita AM</b>
	<b>Set (Inserito)</b>	<b>0V</b>	<b>Off</b>
	<b>Unset (Disins.)</b>	<b>12V o nessuna connessione</b>	<b>On*</b>
			<b>LED</b>
			<b>Off</b>
			<b>On**</b>

\* Microint. 7 ON (Antimascheramento abilitato)  
\*\* Microint. 1 ON (LED abilitati) e ingresso con tensione +12V o nessuna connessione)

## Predisposizione Microinterruttori

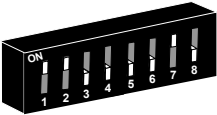

Impostazioni di Fabbrica

### MIC 1: Predisposizione LED

**On:** LED abilitati

**Off:** LED disabilitati

### MIC 2-3: Sensibilità di rilevazione

Sensibilità	MIC2	MIC3
Bassa	Off	Off
Media	Off	On
Normale (Default)	On	Off
Massima *	On	On

\* Con sensibilità massima, la SRT è disabilitata per avere la massima sensibilità

### MIC 4: Sensibilità Anti-Mascheramento

**On:** Alta

**Off:** Bassa

### MIC 5: Ottica Rivelatore

**On:** Barriera / Lunga portata

**Off:** Grandangolo

### MIC 6: LED Rosso o 3 LED

**On:** Solo LED rosso

**Off:** 3 LED

### MIC 7: Antimascheramento

**On:** Abilitato

**Off:** Disabilitato

### MIC 8: Antiavvicinamento

**On:** Abilitato

**Off:** Disabilitato

## Regolazione microonda

Regolare la portata della microonda utilizzando il potenziometro posizionato sulla scheda elettronica del rivelatore.



## Prova di movimento

Dopo 2 minuti dall'alimentazione del sensore, effettuare una prova di movimento all'interno dell'area protetta e verificare il buon funzionamento e la copertura del rivelatore.

Per regolare la copertura del sensore muovere la scheda elettronica interna del sensore per la predisposizione appropriata in funzione dell'altezza di installazione desiderata (1.0m, 1.5m, 2.2m, 2.7m) come stampato nella parte inferiore sinistra della scheda elettronica o utilizzare lo snodo standard.

Per ridurre l'area di copertura spostare in alto la scheda elettronica o, se utilizzato, muovere lo snodo verso il basso.

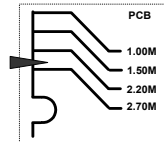

## Indicatori LED

LED	Stato	Descrizione
GIALLO	Acceso	Indica rilevazione PIR
	Lampeggiante	Indica Antimascheramento sull'IR Attivo (AM)
VERDE	Acceso	Indica rilevazione MW
	Lampeggiante	Indica Antiavvicinamento della sezione MW (AM)
ROSSO	Acceso	Indica ALLARME
	Lampeggiante	Indica una anomalia di comunicazione con la ProSYS (solo modalità BUS)
TUTTI I LED	Lampeggiante (uno alla volta)	Inizializzazione dell'unità all'accensione

### Note:

1. Il microinterruttore 1 deve essere posizionato su ON per abilitare i LED.
2. Solo un LED alla volta può illuminarsi. Per esempio, nel caso di attivazione di entrambe le tecnologie PIR e MW, o il LED giallo o quello verde si illumina (il primo che rileva), seguito poi dal LED rosso di allarme.
3. Per prevenire che malintenzionati riescano ad analizzare il momento di attivazione delle tecnologie di rilevazione quali PIR, MW, AM e Antiavvicinamento, impostare il microinterruttore 6 in ON (SW1). In questo modo si accenderà solo il LED rosso.

### Microinterruttore Modalità Relé / BUS

Il microinterruttore J-BUS, situato sulla scheda tra i LED rosso e verde, viene usato per configurare la modalità di funzionamento del rivelatore (vedi figura al lato).

Modalità  
Relé



Modalità  
BUS



### Installazione dello snodo standard

Il kit fornito con il rivelatore da esterno WatchOUT include uno snodo standard per renderne più flessibile l'installazione. Leggere le istruzioni seguenti per installare il rivelatore con questo snodo.

1. Aprire il coperchio frontale (Allentare C1, figura 1).
2. Sganciare la base interna (Svitare I1, figura 2).
3. Aprire i fori a sfondare della base esterna (figura 6, Dettaglio B)
  - W1: Passaggio cavi
  - S1,S2: Fori a sfondare per fissare la base esterna allo snodo standard
  - S3: Predisposizioni per le viti di fissaggio della base esterna
4. Sullo snodo aprire le predisposizioni per il passaggio cavi S2, S7 o S9 (figura 6, Dettaglio A).
5. Rimuovere il tamper antirimozione dalla base interna (consultare paragrafo "Modifica della posizione del tamper antirimozione") e collegarlo a S5 (figura 6, Dettaglio A) sullo snodo standard..

### Nota:

Accertarsi che il marchio **UP** è presente nella parte frontale superiore dello snodo.

6. Selezionare le opzioni di installazione di seguito descritte:

#### Installazione a parete

- a. Inserire il cavo esterno attraverso le predisposizioni S2, S7 o S9 (incluso i cavi del tamper) ed estrarlo facendolo passare attraverso il passaggio cavi dello snodo (figura 6, Dettaglio B).
- b. Fissare lo snodo alla parete tramite i fori S1, S3, S6 ed S8.



## Installazione per tubo elettrico

(utilizzare l'adattatore metallico per tubo elettrico - CSMA, figura 6, Dettaglio A)



Figura 6

### Nota:

Il CSMA è richiesto quando il cablaggio viene effettuato tramite una tubazione elettrica esterna alla parete. Questo accessorio va ordinato separatamente con il codice RA300SC0000A.

- c. Scegliere l'orientamento del CSMA in riferimento al diametro richiesto: 16mm (0.63 in.) o 21mm (0.83 in.).
- d. Inserire il tubo elettrico nel CSMA.
- e. Fissare il CSMA alla parete tramite i fori M1 e M4.
- f. Inserire i cavi esterni e i cavi del tamper che arrivano dal tubo elettrico facendoli passare tramite il passaggio cavi dello snodo (Figura 6, Dettaglio A).
- g. Fissare lo snodo alla parete tramite i fori S1, S3, S6 ed S8.

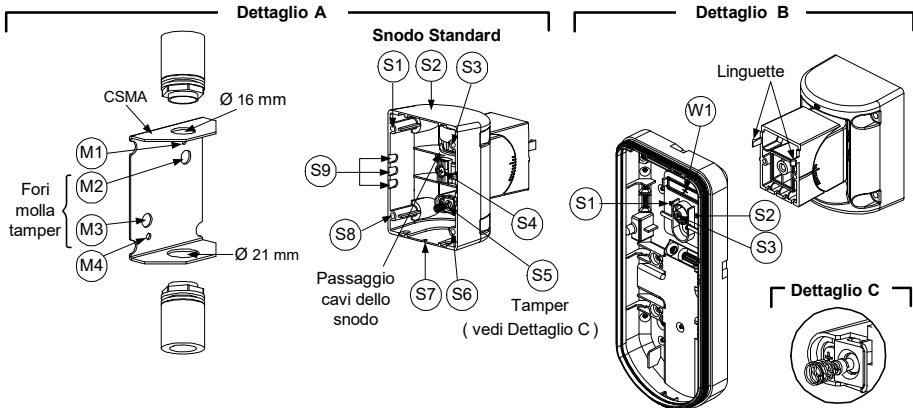
### Nota:

La molla del tamper S5 (Figura 7) deve essere a contatto della parete tramite gli appositi fori M2 o M3 del CSMA. Assicurarsi di sentire il "Click" dell'interruttore tamper fissando il dispositivo alla parete.

7. Inserire i cavi del tamper e i cavi esterni che arrivano dallo snodo standard facendoli passare tramite la predisposizione W1 della base esterna (Figura 7, Dettaglio B).
8. Unire la base esterna allo snodo utilizzando le apposite linguette ad incastro (Figura 7).



Figura 7

**Nota:**

Per fissare la base del rivelatore allo snodo non usare la vite che blocca il fermo posteriore dello snodo. Questa vite non va usata poiché serve solo per il blocco dello snodo una volta orientato come desiderato.

9. Fissare la base esterna allo snodo con due viti tramite le predisposizioni S1 e S2 (figura 7).
10. Inserire nello snodo standard la vite (fornita) di fissaggio ad angolo facendola passare dalla base esterna attraverso il foro a sfondare S3 (figura 7).
11. Orientare orizzontalmente e verticalmente lo snodo fino ad ottenere la posizione desiderata e poi stringere la vite di blocco orientamento snodo.
12. Infilare la base interna nella base esterna ed inserire tutti i cavi attraverso la base interna.
13. Fissare la base interna a quella esterna (fissare I1, figura 2).
14. Per regolare lo snodo standard quando viene installata la scheda elettronica (figura 7):
  - a. Spostare la gomma nera situata sulla scheda elettronica sotto al LED rosso (quanto basta per raggiungere la vite di blocco dello snodo).
  - b. Utilizzare un cacciavite per svitare la vite di blocco (vedi figura 8).
  - c. Orientare orizzontalmente e verticalmente lo snodo fino ad ottenere la posizione desiderata.
  - d. Stringere la vite di blocco orientamento snodo.

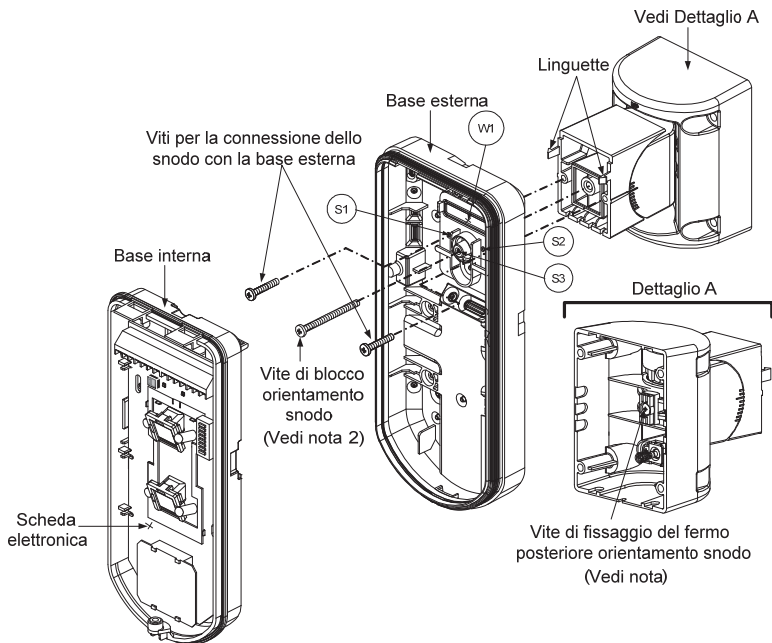
**Nota:**

Quando i punti marcati delle due parti mobili sono allineati (figura 8), lo snodo standard si trova in posizione 0°. Ogni "click" verticale da questa posizione corrisponde ad un incremento / decremento di 5°.

15. Chiudere il coperchio frontale (fissare C1, figura 1) e proseguire con la prova di movimento per verificare l'area di copertura del rivelatore.

**Nota:**

La vite deve passare attraverso la base esterna ed essere fissata allo snodo.



Figura 8

## Sostituzione delle Lenti

1. Nella parte interna del coperchio frontale svitare le sei viti che mantengono il supporto lenti.
2. Per sganciare il supporto delle Lenti effettuare una leggera pressione sulle lenti dalla parte anteriore del coperchio.
3. Sganciare le Lenti dal supporto facendo leggermente leva sulle clip laterali delle Lenti.
4. Sostituire le Lenti. Inserire le 4 clip delle Lenti negli appositi fori del supporto.
5. Inserire il supporto delle Lenti nel coperchio frontale del rivelatore. Prestare particolare attenzione a riposizionare il supporto esattamente sopra la guarnizione di gomma, verificando che anche la lente utilizzata per la protezione verticale dell'unità abbia la guarnizione correttamente posizionata.
6. Fissare il supporto tramite le 6 viti.

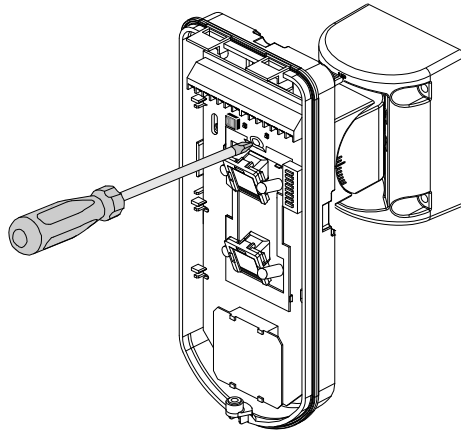
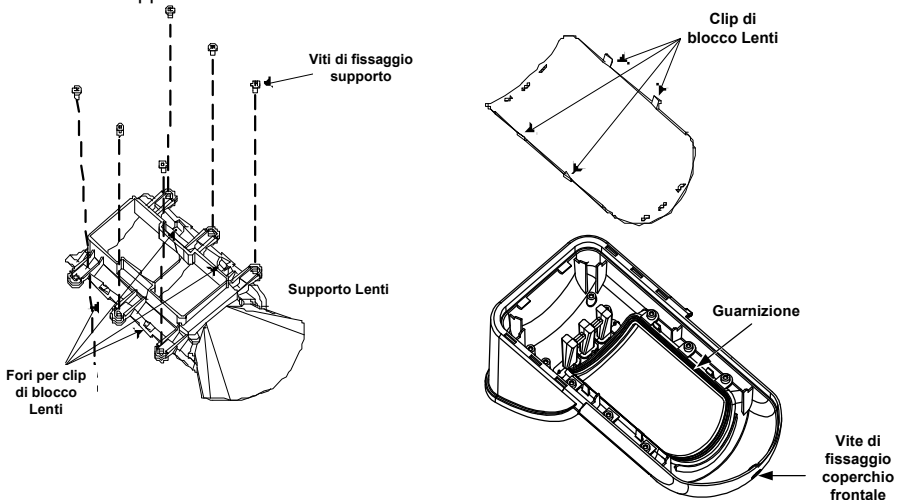

## Tipologie di Lenti

### **Grandangolo (RL300) / Discriminazione animali – Installazione bassa (RL300F) :**

#### **Vista dall'alto**

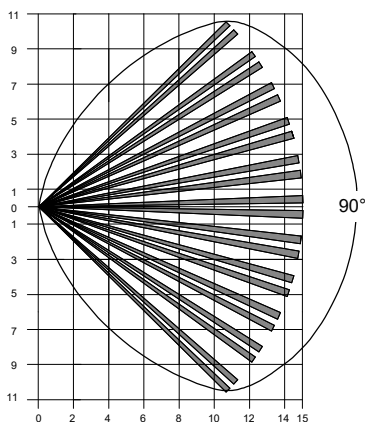

### **Grandangolo (RL300):**

#### **Vista laterale**

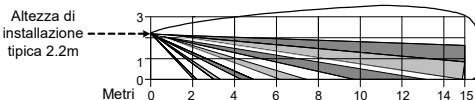

### **Discriminazione animali – Installazione bassa (RL300F) :**

#### **Vista laterale**

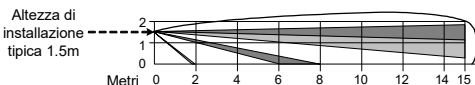

### **Nota:**

L'immunità agli animali del rivelatore (altezza di un animale, nessuna limitazione di peso), è fino a 70 cm, quando viene installato il rivelatore a 2.2m. Se l'installazione è al di sotto di questa altezza, l'immunità agli animali diminuisce proporzionalmente; ogni 10 cm di diminuzione dell'altezza di installazione fa sì che l'immunità agli animali diminuisca di 10 cm.

### **Lenti Lunga Portata (RL300LR):**

#### **Vista dall'alto**

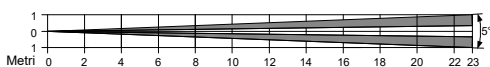

### **Lenti Barriera (RL300B):**

#### **Vista dall'alto**

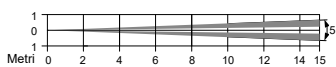

### **Lenti Lunga Portata (RL300LR):**

#### **Vista laterale**

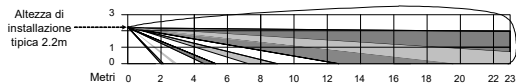

### **Lenti Barriera (RL300B):**

#### **Vista laterale**

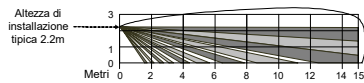

## Caratteristiche Tecniche

Elettriche	
Assorbimento di corrente	30mA a 12 Vcc (a riposo)
	42mA a 12 Vcc (max. con LED illuminati)
Requisiti di alimentazione	9 -16 Vcc
Contatti di Allarme	24 Vcc, 0.1 A
Contatti Antimascheramento	24 Vcc, 0.1 A
Uscita "Lenti Sporche"	Collettore aperto 70mA max.
Potenza trasmessa	10.587GHZ: 10dbm Typ.
Frequenza	10.587GHZ
Fisiche	
Dimensioni LxWxD	230 x 123 x 123mm
Peso	0.632 Kg
Ambientali	
Immunità RF	Conforme alla normativa EN50130-4
Temperatura di Funzionamento/Stoccaggio	Da -30°C a 60°C

\* La tecnologia di rilevazione PIR è limitata in condizioni ambientali critiche.

## Informazioni per l'ordine

### Unità standard

Modello	Descrizione
WatchOUT 315DT	WatchOUT DT + snodo
<b>Nota:</b>	
Ogni rivelatore include lo snodo standard e 3 Lenti: Discriminazione animali per installazioni basse fino a 1.7m (RL300F), Lunga portata (RL300R) e Barriera (RL300B). (I codici prodotto sono marcati sulle Lenti)	

### Kit Accessori

Modello	Descrizione	Peso
RA300B	kit snodo per protezione a barriera	0.1 Kg
RA300P	kit adattatore da palo	0.25 Kg
RA300C	kit adattatore per tubo elettrico	0.6 Kg
RA300HS	contenitore demo WatchOUT	- -
RA300SC	adattatore metallico per tubo elettrico per il montaggio con snodo	1Kg

### Opzioni Telecamera

Modello	Descrizione
WatchOUT VC1	coperchio WatchOUT comprensivo di staffa per telecamera
WatchOUT VC017	kit telecamera grandangolo
WatchOUT VC053	kit telecamera lunga portata
WatchOUT VCPS	alimentatore 220V per telecamera
WatchOUT VCPS	alimentatore 120V per telecamera

## Installazione in modalità BUS

### Introduzione

Le informazioni di questa sezione fanno riferimento all'installazione del WatchOUT 315DT collegato via BUS ai sistemi ProSYS di RISCO. Si possono installare fino a 32 rivelatori connessi al BUS RS-485 della centrale ProSYS risparmiando così tempo per la stesura dei cavi e ottenendo il vantaggio di poter configurare e testare questi rivelatori sia elettricamente che funzionalmente, in locale o da postazione remota.

### Cablaggio morsettiera

<b>+,-</b>	Utilizzati per l'alimentazione 12Vcc del rivelatore. Collegare questi morsetti (+) e (-), rispettivamente ai morsetti AUX RED e COM BLK della centrale ProSYS.
<b>YELLOW</b>	Usato per la comunicazione dei dati via bus ProSYS. Collegare questo morsetto al <b>BUS YEL</b> della ProSYS.
<b>GREEN</b>	Usato per la comunicazione dei dati via bus ProSYS. Collegare questo morsetto al <b>BUS GRN</b> della ProSYS.
<b>TAMPER</b>	Usato per il cablaggio del circuito antimanomissione. Consultare gli schemi che seguono.
<b>LED ENABLE</b>	Usato per il cablaggio del circuito antimanomissione. Consultare gli schemi che seguono.

#### Nota:

I morsetti non descritti in tabella non vengono utilizzati nella modalità di connessione BUS.

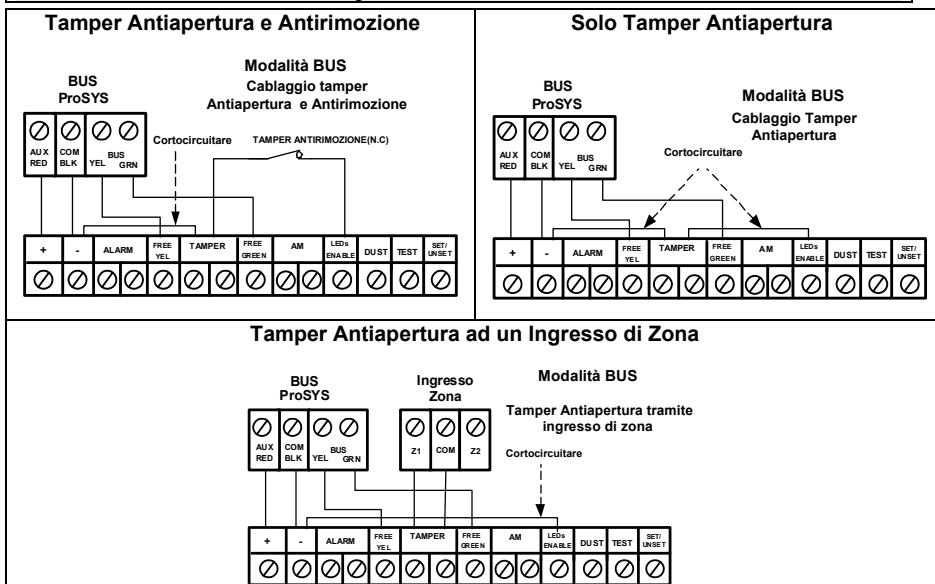

## Predisposizione microinterruttori

N° Microint.	Descrizione
1 - 5	Usati per impostare l'indirizzo ID del rivelatore. Impostare l'indirizzo ID del rivelatore così come per ogni altro modulo PROSYS. Consultare il manuale di "Installazione e Programmazione", sezione di "Configurazione degli Indirizzi ID dei Moduli". (Fare riferimento alla tabella che segue)
6 - 8	Non usati

### Indirizzo ID WatchOUT ID: Microinterruttori 1 - 5

ID	1	2	3	4	5
01	OFF	OFF	OFF	OFF	OFF
02	ON	OFF	OFF	OFF	OFF
03	OFF	ON	OFF	OFF	OFF
04	ON	ON	OFF	OFF	OFF
05	OFF	OFF	ON	OFF	OFF
06	ON	OFF	ON	OFF	OFF
07	OFF	ON	ON	OFF	OFF
08	ON	ON	ON	OFF	OFF
09	OFF	OFF	OFF	ON	OFF
10	ON	OFF	OFF	ON	OFF
11	OFF	ON	OFF	ON	OFF
12	ON	ON	OFF	ON	OFF
13	OFF	OFF	ON	ON	OFF
14	ON	OFF	ON	ON	OFF
15	OFF	ON	ON	ON	OFF
16	ON	ON	ON	ON	OFF

ID	1	2	3	4	5
17	OFF	OFF	OFF	OFF	ON
18	ON	OFF	OFF	OFF	ON
19	OFF	ON	OFF	OFF	ON
20	ON	ON	OFF	OFF	ON
21	OFF	OFF	ON	OFF	ON
22	ON	OFF	ON	OFF	ON
23	OFF	ON	ON	OFF	ON
24	ON	ON	ON	OFF	ON
25	OFF	OFF	OFF	ON	ON
26	ON	OFF	OFF	ON	ON
27	OFF	ON	OFF	ON	ON
28	ON	ON	OFF	ON	ON
29	OFF	OFF	ON	ON	ON
30	ON	OFF	ON	ON	ON
31	OFF	ON	ON	ON	ON
32	ON	ON	ON	ON	ON

## Programmazione ProSYS

La sezione che segue descrive le opzioni software aggiuntive che riguardano la programmazione del WatchOUT DT come rivelatore indirizzato su BUS. Si possono aggiungere al sistema ProSYS fino a 32 rivelatori indirizzati su BUS (16 per la ProSYS 16) ed ognuno di essi prende il posto di una zona del sistema. Si consiglia di leggere attentamente i manuali di Installazione e Utente ProSYS prima di programmare il WatchOUT.

### Note:

WatchOUT è compatibile con i sistemi ProSYS Versione software 4.xx e successive la funzione Antiavvicinamento, via BUS dalla versione 7.xx. WatchOUT può essere programmato via software di Teleassistenza Rokonet Versione 2.xx e successive.

Per avere la massima stabilità del sistema è consigliabile NON superare la distanza massima di cablaggio di 300 metri calcolati sommando tutte le diramazioni del BUS di Espansione. Per distanze maggiori consultare il manuale di "Installazione e Programmazione ProSYS" alla sezione "Note sui Cavi da utilizzare".

### Aggiunta e Cancellazione del WatchOUT DT

WatchOUT è parte di una nuova categoria di accessori ProSYS chiamati Zone-BUS quindi, Aggiungere o Cancellare dal sistema un WatchOUT è una procedura identica a quella effettuata per qualsiasi altro modulo accessorio ad eccezione del fatto che: **Ogni Rivelatore BUS deve essere assegnato a una zona del sistema.**

Ogni rivelatore su BUS può essere assegnato ad una zona fisica cablata del sistema o ad una zona virtuale.

**Zona Fisica:** è una qualsiasi zona della scheda principale ProSYS (zone 1-8) o di una espansione cablata (ZE08, FZ08, ZE16).





**Zona Virtuale:** è una qualsiasi zona di una espansione zone BUS definita come BZ08 o BZ16.

### Note:

Le espansioni zone BUS espandono il sistema senza aggiungere fisicamente espansioni. Le espansioni zone BUS virtuali possono essere usate solo per il collegamento di rivelatori su BUS.





Per aggiungere una espansione zone BUS virtuale selezionare la tipologia BZ08 o BZ16 nella procedura di Aggiungi Modulo espansione zone in Programmazione Tecnica (tasti rapidi [7][1][2])

## 1. Per Aggiungere o Cancellare un WatchOUT DT procedere come segue

1. Dalla Programmazione Tecnica selezionare il menù Accessori e quindi AGG/CANC. MDL per aggiungere una Zona BUS: tasti rapidi [7][1][9][5].
2. Usare i tasti  /  o  /  per posizionare il cursore sopra il campo del numero ID della Zona BUS da aggiungere/cancellare.

### Nota:

Assicurarsi che il numero di indirizzo ID programmato sul rivelatore sia identico al numero ID selezionato durante la fase di programmazione descritta.



3. Posizionare il cursore sul campo TIPO e usare il tasto  /  fino a selezionare il modello "ODT15" per il rivelatore WatchOUT DT.
4. Premere  /  per confermare.
5. Ripetere lo stesso procedimento per eventuali altri rivelatori su BUS.

## 2. Assegnazione del WatchOUT DT a una zona

1. Dal menù di Programmazione Tecnica selezionare il menù Zone, poi il menù Una per Una (tasti rapidi [2][1])
2. Digitare il numero della zona da assegnare al rivelatore.



### Note:

Se si è definita una espansione zone BUS virtuale, selezionare il numero di una zona riferita a questa espansione.

3. Selezionare le partizioni, i Gruppi, la Tipologia di zona e la Risposta.
4. Raggiunta l'opzione Terminazione selezionare [5] Zona BUS e premere  / .





```
Z:001 ASSEGNA A
ID:01 TIPO=ODT15
```

Il display mostrerà:

5. Selezionare il numero di zona BUS da assegnare alla zona che si sta programmando. Il campo **TIPO** verrà automaticamente aggiornato con il modello del rivelatore.
6. Premere  / . La RISPOSTA LOOP non è applicabile alle zone BUS quindi il

```
Z:001 RISP.LOOP:
FUNZ. NON USATA
```



display mostrerà:

7. Premere  / , e programmare una etichetta di testo alla zona poi, per finire, premere  / .

## 3. Configurazione dei parametri del WatchOUT DT

1. Per accedere al menù di configurazione parametri del WatchOUT, premere in Prog. Tecnica [2][0][3]. Il display mostrerà:

```
PARAM. Z-BUS:
ZONA= 001 (M:ZZ)
```

2. Selezionare la zona alla quale il rivelatore su BUS è stato assegnato e premere  / . Adesso è possibile programmare i parametri del WatchOUT come segue:



## Zone, Varie: Parametri Zone BUS

Tasti rapidi	Parametro	Default
[2][0][3][zzz] [1]	<b>LED</b> Configura il funzionamento dei LED.	<b>3 LED</b>
[2][0][3][zzz] [1][1]	<b>Off</b> LED disabilitati.	
[2][0][3][zzz] [1][2]	<b>Solo il Rosso</b> Solo il LED rosso è attivo. L'opzione è consigliata per evitare che l'intruso comprenda comportamento e aree di copertura del rivelatore.	
[2][0][3][zzz] [1][3]	<b>3 LED</b> Tutti e tre i LED sono attivi.	
[2][0][3][zzz] [2]	<b>Sensibilità</b> Configura la sensibilità del rivelatore (MW + PIR)	<b>Normale</b>
[2][0][3][zzz] [2][1]..[4]	<b>Opzioni Sensibilità</b> 1) Bassa                      3) Normale 2) Media                      4) Alta	
[2][0][3][zzz] [3]	<b>Portata MW</b> Permette di configurare la portata della sezione microonda. La portata massima è di circa 23 metri.	<b>Trimmer</b>
[2][0][3][zzz] [3][1]..[7]	<b>Portata MW</b> 1) Minimo    3) 40%    5) 80%    7) Trimmer (la portata è quella 2) 20%    4) 60%    6) Massimo    impostata dal trimmer dell'unità)	
[2][0][3][zzz] [4]	<b>Sensibilità Anti-Mascheramento</b> Definisce la sensibilità dell'IR attivo Anti-Mascheramento	<b>Bassa sensibilità</b>
[2][0][3][zzz] [4][1]-[2]	<b>Opzioni Sensibilità Anti-Mascheramento</b> 1) Bassa Sensibilità    2) Alta Sensibilità	
[2][0][3][zzz] [5]	<b>Tipologia Lenti</b> Configura il rivelatore per funzionare con il tipo di lenti installate.	<b>Grandangolo</b>
[2][0][3][zzz] [5][1]..[2]	<b>Opzioni Tipologie di Lenti</b> 1) Grandangolo    2) Barriera o Lunga Portata.	
[2][0][3][zzz] [6]	<b>Anti-Mascheramento</b> Configura l'opzione Antimascheramento del rivelatore.	<b>Abilitato</b>
[2][0][3][zzz] [6][1]..[2]	<b>Opzioni Anti-mascheramento</b> 1) Disabilitato    2) Abilitato (Default)	
[2][0][3][zzz] [7]	<b>Inserito/Disinserito</b> Imposta il funzionamento dei LED e dell'Anti-Mascheramento quando il sistema è inserito.	<b>No</b>
[2][0][3][zzz] [7][1]	<b>No</b> L'Anti-Mascheramento (IR attivo e Antiavvicinamento) è abilitato Il funzionamento dei LED dipende dalla definizione del parametro LED	
[2][0][3][zzz] [7][2]	<b>Si</b> L'Anti-Mascheramento (IR attivo e Antiavvicinamento) e LED disabilitati ad impianto inserito.	
[2][0][3][zzz] [8]	<b>Prox. AM</b> Configura l'opzione Antiavvicinamento del rivelatore.	<b>Disabilitato</b>
[2][0][3][zzz] [8][1]..[2]	<b>Opzioni Prox. AM</b> 1) Disabilitato (Default)    2) Abilitato <b>NOTA:</b> Con la funzione 'Antiavvicinamento' abilitata e il sensore installato a cielo aperto, si raccomanda di creare un riparo sopra di esso per evitare allarmi impropri in presenza di forti piogge o alternativamente disabilitare la funzione.	









## Parametri di Sistema

### Sistema: Controlli SIS

Tasti rapidi	Parametro	Default
[1][2][36]	<b>IR AM=Tamper</b>	<b>No</b>
	Utilizzato per determinare la risposta del sistema alla rilevazione di un mascheramento. <b>Si:</b> Anti-mascheramento come allarme tamper. <b>No:</b> Anti-mascheramento come anomalia.	
[1][2][37]	<b>Prox AM =Tamper</b>	<b>No</b>
	Usato per determinare il modo di risposta del Sistema in caso di un'attivazione dell'Antiavvicinamento <b>Si:</b> L'attivazione dell'Antiavvicinamento genererà un allarme tamper <b>No:</b> L'attivazione dell'Antiavvicinamento genererà una condizione di guasto nel sistema.	

### Diagnostica

ProSYS permette la diagnostica dei parametri che determinano di funzionamento del rivelatore WatchOUT.

- In tastiera, con il display nel modo normale di funzionamento, premere i tasti  [4] per accedere al menù Manutenzione.
- Inserire il codice Tecnico (o il codice sub-tecnico) e premere  / .
- Premere **[9] [1]** per accedere al menù di Diagnostica Zone.
- Selezionare la zona che si vuole testare premere  / . Il sistema effettuerà il test della zona e il display mostrerà una lista di parametri riportati e spiegati nella tabella che segue.
- Usare i tasti  /   /  per scorrere la lista di parametri e verificare i risultati dei test.

### Menù Funzioni Utente: 4) Manutenzione → 9) Diagnostica → 1) Zone BUS

Tasti rapidi	Parametro
[4][9][1][zzz]	<b>Alimentaz.:</b> Visualizza la tensione di alimentaz. del rivelatore. <b>Liv. PIR 1:</b> visualizza il livello di segnale in tensione continua del PIR 1. (0.1v – 4v). <b>Rumore PIR 1:</b> visualizza il livello di rumore in tensione alternata del PIR 1. (0Vca (Nessun rumore) – 4Vca). <b>Liv. PIR 2:</b> visualizza il livello di segnale in tensione continua del PIR 2. (0.1v – 4v). <b>Rumore PIR 2:</b> visualizza il livello di rumore in tensione alternata del PIR 2. (0Vca (Nessun rumore) – 4Vca). <b>Livello MW 1:</b> visualizza il livello di rumore in tensione continua del canale MW1. (0.1v – 4v). <b>Rumore MW 1:</b> visualizza il livello di rumore in tensione alternata del canale MW 1 (0Vca (nessun rumore) – 4Vca). <b>Livello MW 2:</b> visualizza il livello di rumore in tensione continua del canale MW2. (0.1v – 4v). <b>Rumore MW 2:</b> visualizza il livello di rumore in tensione alternata del canale MW 2 (0Vca (nessun rumore) – 4Vca).

# Índice de Contenidos

<b>Instalación en Modo Relé .....</b>	<b>36</b>
<b>Introducción .....</b>	<b>36</b>
<b>Montaje.....</b>	<b>36</b>
Consideraciones de Montaje .....	36
Instalación de Montaje en Pared .....	37
Montaje en pared:.....	37
Montaje en ángulo de 45° (montaje del lado izquierdo) .....	37
Cambiando la posición del Tamper Posterior.....	38
<b>Cableado de los terminales .....</b>	<b>38</b>
<b>Configuración de los interruptores DIP .....</b>	<b>39</b>
<b>Ajuste del Microondas.....</b>	<b>39</b>
Prueba de paseo .....	39
<b>Visualización de los LEDs.....</b>	<b>40</b>
<b>Puente Modo Relé / Modo BUS .....</b>	<b>40</b>
<b>Instalación del Soporte con Rótula Giratoria Estándar.....</b>	<b>40</b>
Montaje en Pared .....	40
Montaje del Adaptador a tubo del Soporte con Rótula Giratoria .....	41
<b>Cambio de las Lentes.....</b>	<b>43</b>
Tipos de Lente .....	44
<b>Especificaciones Técnicas .....</b>	<b>45</b>
<b>Información para Pedidos .....</b>	<b>45</b>
<b>Instalación en Modo BUS .....</b>	<b>46</b>
<b>Introducción .....</b>	<b>46</b>
<b>Cableado de los terminales .....</b>	<b>46</b>
<b>Configuración de los interruptores DIP .....</b>	<b>46</b>
<b>Programación de las centrales ProSYS.....</b>	<b>47</b>
<b>Parámetros del Sistema.....</b>	<b>49</b>

# Instalación en Modo Relé

## Introducción

El detector de Exterior de Doble Tecnología de RISCO Group, WatchOUT 315DT, es un detector único con tratamiento de señal basado en dos canales Infrarrojos Pasivos (PIR) y en dos canales de Microondas (MW). El detector puede funcionar como un detector de relé normal conectado a cualquier panel de control, o como un accesorio en BUS cuando se conecta al panel de control ProSYS de RISCO Group a través del BUS RS485, teniendo así capacidades únicas de control remoto y diagnóstico.

Las siguientes instrucciones describen el WatchOUT 315DT en modo Relé y BUS. Para información detallada de la instalación en modo BUS, ver el capítulo Instalación en Modo Bus.

## Montaje

### Consideraciones de Montaje

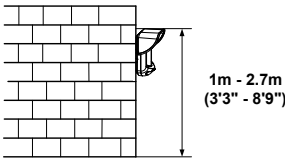

Altura Opcional: 1m – 2.7m (3'3"-8'9")

Altura Típica: 2.2m (7'2")

Lentes predeterminadas: Gran angular 15m (50') 90° (RL300)



#### Nota:

1. Para instalaciones bajas de altura, por debajo de 1.7m (5'6") en las cuales se necesite la inmunidad contra pequeños animales, usar la lente suministrada RL300F (instalaciones en paredes o vallas bajas).
2. La inmunidad contra pequeños animales del detector (altura de un animal, sin límite de peso) es hasta 70cm (2'4"), cuando el detector se instala a 2.2m (7'2"). Si la instalación es por debajo de la altura mencionada arriba, la inmunidad contra mascotas disminuye proporcionalmente; cada reducción de 10cm (4") en la altura de la instalación conlleva una reducción de 10cm (4") en la inmunidad contra mascotas (altura del animal).

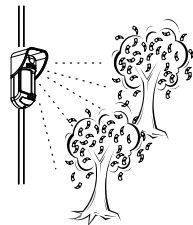

Evitar apuntar el detector hacia objetos que se muevan (árboles balanceándose, arbustos,...)

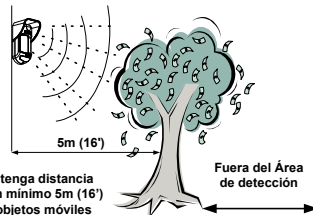

Asegurarse de que ningún objeto obstruya el campo de visión de ambas tecnologías. Prestar atención a los árboles o arbustos en crecimiento, a las plantas con grandes hojas que se mueven, etc.

En instalaciones con mucho tráfico de vehículos o blancos fuera del rango de detección requerido, se recomienda ajustar la sensibilidad del MW y/o inclinar el detector hacia abajo.

#### Nota:

Inclinar el detector hacia abajo puede reducir la inmunidad contra pequeños animales.

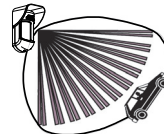

Para conseguir una óptima detección, seleccionar una ubicación del detector en la que sea probable interceptar a un intruso moviéndose a través del patrón de cobertura en una trayectoria de 45°.

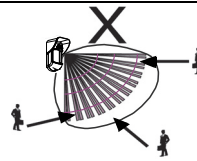
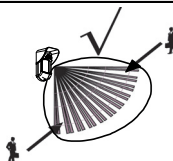

NOTA: Desabilite el AM de proximidad durante una lluvia intensa (si el WatchOUT 315DT esta a la intemperie) para prevenir alertas de Proximidad AM.

## Instalación de Montaje en Pared

### Nota:

Los números pre-marcados de instalación están señalados en la placa posterior.

1. Abrir la tapa delantera del WatchOUT (Desatornillar C1, Figura 1).
2. Liberar la base interna (Abrir I1, Figura 2).
3. Seleccionar la instalación de montaje como sigue:

### Montaje en Pared:

Liberar los agujeros pre-marcados en la base externa (Figura 3).

- B1 - B4: Agujeros pre-marcados de montaje en pared
- T1: Agujero pre-marcado del tamper trasero
- W2 / W3: Agujeros pre-marcados para entrada de cables

### Montaje en ángulo de 45° (montaje del lado izquierdo)

- a. Abrir los agujeros pre-marcados en la base externa (Figura 3)
  - L1, L2: Agujeros pre-marcados de montaje del lado izquierdo
  - T3: Agujero pre-marcado del tamper izquierdo
  - W5 / W6: Agujeros pre-marcados para entrada de cables
- b. Quitar el resorte del tamper
- c. Reemplazar la abrazadera del tamper (Ítem 1) con la abrazadera plana suministrada (Ítem 2).

Ítem 1



Ítem 2



- d. Insertar la palanca del tamper B en T5 y T3 y apretar el tornillo A (Figura 3)
4. Pasar los cables externos a través de la base externa W2, W3 (montaje plano) o W5, W6 (montaje lado izquierdo) (Figura 3)
  5. Fijar la base externa a la pared.
  6. Pasar los cables externos y los cables del tamper a través de la base interna (Figura 4).
  7. Fijar la base interna a la base externa (cierre I1, Figura 2).
  8. Cerrar la tapa delantera (cierre C1, Figura 1) después de cablear y configurar los interruptores DIP.
  9. Realizar una prueba de paseo del detector.

Figura 1



Figura 2



Figura 3

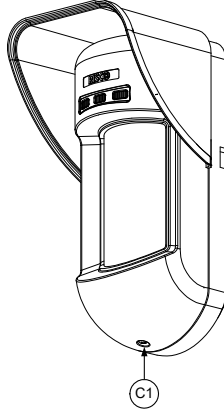

Figura 4

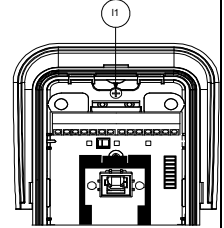

**Nota:**

Para la instalación del lado derecho a 45° usar lo equivalente en la base externa como sigue:

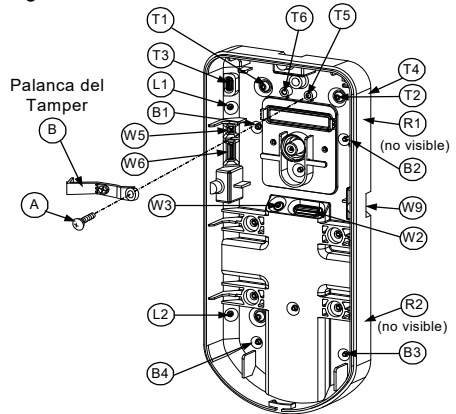
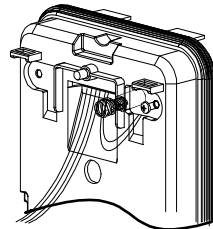
Descripción agujeros pre-marcados	Izquierda	Derecha
Agujeros de montaje	L1, L2	R1, R2
Agujeros del resorte del tamper	T1, T3	T2, T4
Anclaje del tornillo del tamper	T5	T6
Agujeros de cableado	W5, W6	W7, W8

**Cambiar la posición del Tamper Posterior**

El tamper posterior, por defecto, se asegura en el lado derecho de la base (vista posterior). Si desea moverlo al lado izquierdo (vista posterior), haga lo siguiente (Figura 5):

1. Quitar el tornillo 1 del tamper para liberar el tamper de la posición 7.
2. Asegurarse de que el resorte 2 del tamper está asentado sobre la base del cable del tamper 4.
3. Asegurarse de que la abrazadera de plástico del tamper 3 esté asentada en el 2 y 4.
4. Colocar el tornillo del tamper 1 en el 3 sobre la posición 6.

Figura 5

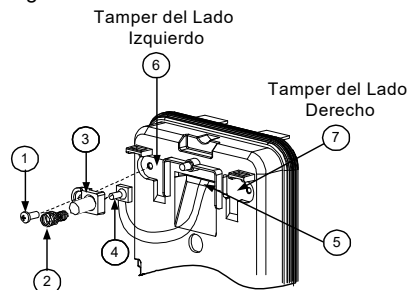
**Notas:**

1. Asegurarse de escuchar un "clic" al fijar el resorte del tamper a la pared.
2. Para instalación en poste, el tamper puede moverse a la parte inferior del lado derecho de la base interna.

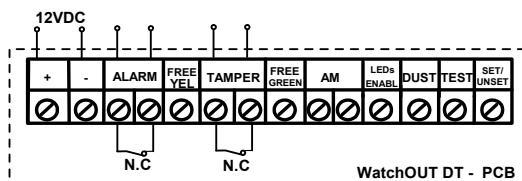
**Cableado de los terminales**

<b>+,-</b>	12 VCC
<b>ALARM</b>	Relé N.C., 24 VCC, 0.1A
<b>FREE YEL</b>	Este terminal está libre y puede ser usado para conectar cables y resistencias EOL (final de línea)
<b>TAMPER</b>	Relé N.C., 24 VCC, 0.1A
<b>FREE GREEN</b>	Este terminal está libre y puede ser usado para conectar cables y resistencias EOL (final de línea)
<b>AM</b>	Salida de relé de AM normalmente cerrada (24 VCC, 0.1A) indica alarma Anti-Enmascaramiento o cualquier problema en el detector (a excepción de polvo/lente sucia). El AM de Proximidad permite recibir alertas de sabotaje antes de que el detector sea enmascarado o dañado, utilizando los dos canales de microondas. <b>Nota:</b> AM de Proximidad. Cuando DIP8 está habilitado, este relé también abre cuando se produce una detección de AM por Proximidad. En este caso, el relé permanecerá abierto durante un tiempo mínimo de 20 segundos y se cerrará cuando se detecte movimiento.
<b>LED ENABLE</b>	Usado para controlar remotamente los LEDs cuando el <b>DIP1</b> está en ON. Activado: entrada de +12V (function OR) sin conexión al terminal Desactivado: conectar la entrada a 0V
<b>DUST</b>	N/A

<b>TEST</b>	Usado para realizar pruebas remotas de alarma al detector, aplicando 0 voltios a este terminal. Test OK: El Relé de alarma se abre momentáneamente. Fallo: Se abre la salida AM.												
<b>SET/ UNSET</b>	Esta entrada permite habilitar o deshabilitar el Anti-enmascaramiento y los LEDs, según el estado del sistema: Armado o Desarmado. Cuando el sistema está armado, esta función impide a un intruso conocer el estado del detector y desactiva la detección Anti-enmascaramiento.												
	<table border="1"> <thead> <tr> <th>Estado del Sistema</th> <th>Estado de la entrada</th> <th>Relé AM</th> <th>LEDs</th> </tr> </thead> <tbody> <tr> <td><b>Armado</b></td> <td><b>0V</b></td> <td><b>Off</b></td> <td><b>Off</b></td> </tr> <tr> <td><b>Desarmado</b></td> <td><b>12V o sin conexión</b></td> <td><b>On*</b></td> <td><b>On**</b></td> </tr> </tbody> </table> <p>* DIP7 está en ON (Anti-enmascaramiento habilitado) ** DIP1 en ON (LEDs activados) y el terminal de entrada LEDs ACTIVADO está activado (+12V, o sin conexión al terminal)</p>	Estado del Sistema	Estado de la entrada	Relé AM	LEDs	<b>Armado</b>	<b>0V</b>	<b>Off</b>	<b>Off</b>	<b>Desarmado</b>	<b>12V o sin conexión</b>	<b>On*</b>	<b>On**</b>
Estado del Sistema	Estado de la entrada	Relé AM	LEDs										
<b>Armado</b>	<b>0V</b>	<b>Off</b>	<b>Off</b>										
<b>Desarmado</b>	<b>12V o sin conexión</b>	<b>On*</b>	<b>On**</b>										

## Configuración de los interruptores DIP

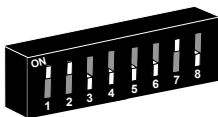

**Predeterminado de Fábrica**

**DIP 1:** Funcionamiento de los LEDs

On: LEDs Activados

Off: LEDs Desactivados

**DIP 2-3:** Sensibilidad de Detección

Sensibilidad	DIP2	DIP3
Baja	Off	Off
Media	Off	On
Normal (Predeterm.)	On	Off
Máxima*	On	On

\* En la máxima sensibilidad el reconocimiento de oscilación se desactiva para alcanzar el máximo de sensibilidad

**DIP 4:** Sensibilidad Anti-enmascaramiento

On: Alta

Off: Baja

**DIP 5:** Óptica del detector

On: Barrera / Largo alcance

Off: Gran angular

**DIP 6:** LED Rojo / 3 LED

On: Sólo LED rojo

Off: 3 LEDs

**DIP 7:** Funcionamiento Anti-enmascaramiento

On: Habilitado

Off: Deshabilitado

**DIP 8:** AM de Proximidad

On: Habilitado

Off: Deshabilitado

## Ajuste del Microondas

Ajustar el área de cobertura del Microondas usando el potenciómetro de la PCB (placa de circuito impreso).

## Prueba de paseo

Dos minutos después de aplicar alimentación, hacer la prueba de paseo en el área protegida para verificar su correcto funcionamiento. En instalaciones en superficies desniveladas, deslice el PCB dentro de la base interna al ajuste apropiado según la altura deseada (1.0m, 1.5m, 2.2m, 2.7m) como está impreso en la esquina inferior izquierda del PCB o use el soporte con rótula giratoria estándar.

Para reducir el alcance de detección, deslizar el PCB hacia arriba o inclinar el soporte con rótula giratoria hacia abajo. **Tenga en cuenta que al hacer esto la inmunidad contra pequeños animales puede verse reducida.**

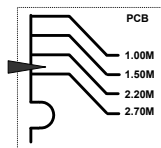

## Visualización de los LEDs

LED	Estado	Descripción
YELLOW	Encendido	Indica detección del PIR
	Parpadea	Indica detección de AM (Anti-enmascaramiento)
GREEN	Encendido	Indica detección del MW
	Parpadea	Indica detección de AM de Proximidad
RED	Encendido	Indica ALARMA
	Parpadea	Indica fallo en la comunicación con la central ProSYS (sólo en el modo BUS)
Todos los LEDs	Parpadean (uno después de otro)	Inicialización de la unidad al encender.

### Notas:

1. El interruptor DIP 1 debe estar en la posición ON para habilitar las indicaciones del LED.
2. Solamente un LED está activo al mismo tiempo. Por ejemplo, en el caso de detección simultánea PIR y MW, se visualiza de forma constante el LED AMARILLO o el VERDE (el primero que detecta), seguido del LED ROJO de Alarma.
3. A fin de evitar que se analicen cómo funcionan las tecnologías de detección de una Alarma, Anti-Enmascaramiento o AM de Proximidad, colocar el interruptor DIP 6 (SW1) en posición ON. De esta manera sólo se activará el LED rojo.

### Puente Modo Relé / Modo BUS

El Puente J-BUS (situado en el PCB entre los LEDs rojo y verde) se usa para definir el modo de funcionamiento del detector, de la siguiente manera:

Modo Relé



Modo BUS



### Instalación del Soporte con Rótula Giratoria Estándar

El detector de Exterior se entrega con un soporte con rótula giratoria estándar para permitir una mayor flexibilidad en la instalación. Por favor, siga las instrucciones indicadas a continuación para montar el detector con el Soporte con Rótula Giratoria Estándar:

1. Abrir la tapa delantera del WatchOUT (Desatornillar C1, Figura 1).
2. Liberar la base interna (liberar I1, Figura 2).
3. Abrir los agujeros pre-marcados en la base externa (Figura 6, Detalle B)
  - W1: Agujeros pre-marcados para los cables
  - S1, S2: Agujeros pre-marcados para asegurar la base externa al Soporte con Rótula Giratoria Estándar
  - S3: Agujero para el tornillo de fijación de la base externa
4. En el soporte con rótula giratoria rompa el agujero pre-marcado que necesite para pasar el cableado por la rótula: S2, S7 o S9 (Figura 6, Detalle A).
5. Extraer el tamper posterior de la base interna (ver el apartado "Cambiar la Posición del Tamper Posterior") y conectarlo a S5 (Figura 6, Detalle A) en el Soporte con Rótula Giratoria Estándar.

### Nota:

Asegurarse de ver la marca grabada **UP** en la parte superior del frontal del Soporte con Rótula Giratoria.

6. Seleccionar el tipo de montaje de instalación como se indica a continuación:

#### Montaje en Pared

- a. Pasar el cable externo a través de los agujeros pre-marcados S2, S7 o S9 (incluyendo los cables del tamper) a través del Conducto de los Cables del Soporte con Rótula Giratoria (Figura 6, Detalle B).
- b. Fijar el soporte con la rótula giratoria a la pared a través de los agujeros S1, S3, S6 y S8.



Montaje del adaptador a tubo en el Soporte con Rótula Giratoria (usando el Adaptador metálico de tubo del Soporte con Rótula Giratoria - CSMA, Figura 6, Detalle A).



Figura 6

**Nota:**

El CSMA es necesario cuando el cableado va por un tubo no empotrado en la pared y se necesita proteger los cables. El CSMA debe pedirse por separado – Ref. RA300SC0000A.

- Elegir la orientación del CSMA según el diámetro necesario: 16mm (0.63 pulgadas) ó 21mm (0.83 pulgadas).
- Insertar el tubo eléctrico al CSMA.
- Fijar el CSMA a la pared a través de los puntos (M1, M4).
- Introducir los cables externos y los cables del tamper que llegan del tubo eléctrico haciéndolos pasar a través del paso de cables del soporte con rótula giratoria (Figura 6, Detalle A).
- Fijar el soporte con rótula giratoria a la pared mediante los agujeros S1, S3, S6 y S8.

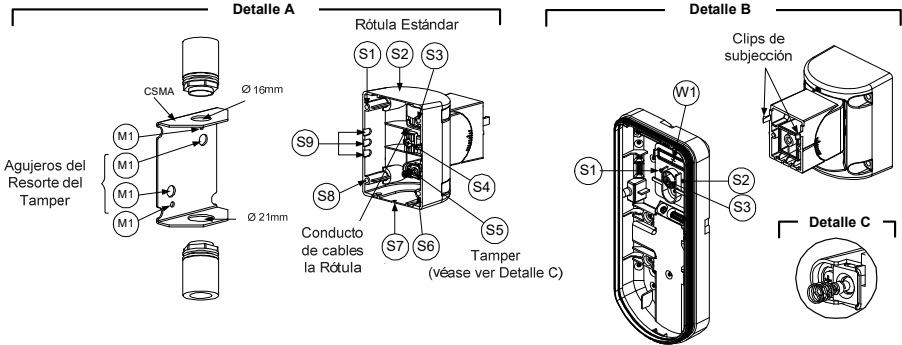
**Nota:**

El resorte del tamper S5 (Figura 6, Detalle A) debe hacer contacto con la pared a través de los agujeros de los resortes del tamper M2 o M3 en el CSMA. Asegurarse de ello al oír el "Clic" del interruptor del tamper al fijar el dispositivo a la pared.

- Pasar los cables del tamper y los cables de conexión que llegan del Soporte con Rótula Giratoria a través del agujero pre-marcado W1 en la base externa (Figura 6, Detalle B).
- Conectar la base externa del detector al soporte con rótula giratoria mediante los correspondientes clips (Figura 7).



Figura 7

**Nota:**

Para fijar la base del detector al soporte con rótula giratoria no utilizar el tornillo que bloquea el giro posterior de la rótula del soporte. Dicho tornillo solamente sirve para bloquear la rótula una vez que el detector haya sido orientado a su campo de detección.

9. Fijar la base externa del detector al soporte con rótula giratoria mediante los 2 tornillos de los orificios pre-marcados S1 y S2 (Figura 7).
10. Insertar en el soporte con rótula el tornillo de fijación en ángulo, que se suministra con el detector, haciéndolo pasar por el orificio pre-marcado S3 (Figura 7).
11. Orientar horizontal y verticalmente el Soporte con Rótula Giratoria Estándar a la posición deseada. Una vez que la Rótula Giratoria Estándar esté en la posición deseada, apretar el tornillo de fijación del ángulo.
12. Alinear la base externa del detector con la base interna y hacer pasar todos los cables por dicha base interna.
13. Asegurar la base interna a la base externa (Cierre I1, Figura 2).
14. Para volver a orientar el Soporte con Rótula Giratoria Estándar cuando el circuito impreso PCB está instalado (Figura 8) hacer lo siguiente:
  - a. Levantar la espuma negra situada debajo del LED ROJO en el PCB (lo suficiente para acceder al tornillo de fijación del Soporte con Rótula Giratoria).
  - b. Utilizar un destornillador de estrella para liberar el tornillo de fijación (ver Figura 8).
  - c. Orientar el Soporte con Rótula Giratoria Estándar hasta la posición deseada.
  - d. Apretar el tornillo de fijación de la rótula.

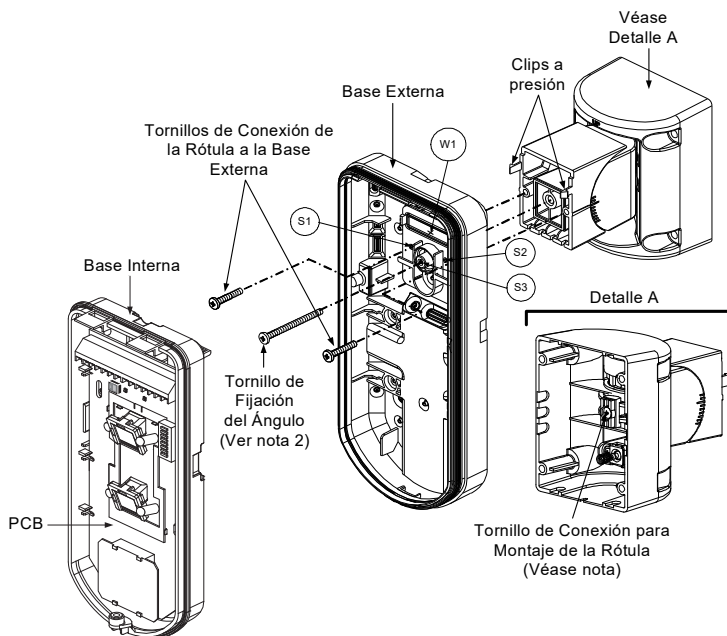
**Nota:**

Cuando las marcas de las dos partes móviles están alineadas (Figura 8), el Soporte con Rótula Giratoria Estándar estará en la posición vertical / horizontal 0°. Cada señal desde esta posición representa un desplazamiento de 5° en la posición vertical / horizontal.

15. Cerrar la tapa frontal (Cierre C1, Figura 1) y hacer una prueba de paseo del detector.

**Nota:**

El tornillo debe pasar a través de la Base Externa y fijarse al Soporte con Rótula Giratoria.

ES



Figura 8

## Cambio de las Lentes

1. Aflojar y quitar los seis tornillos de la parte posterior de la tapa frontal del detector que mantienen la funda protectora de la lente.
2. Empujar suavemente la lente desde el lado externo de la tapa delantera para liberar la funda protectora.
3. Desenganchar la lente de la funda empujando suave y lateralmente los clips de fijación que la sujetan a la funda.
4. Sustituir la lente. Colocar los 4 clips de la lente en los agujeros apropiados en la funda.
5. Volver a insertar la funda protectora en su lugar en la tapa delantera. Poner atención al colocar la funda sobre la goma de sellado.
6. Fijar el soporte apretando los 6 tornillos colocados de nuevo en su lugar.

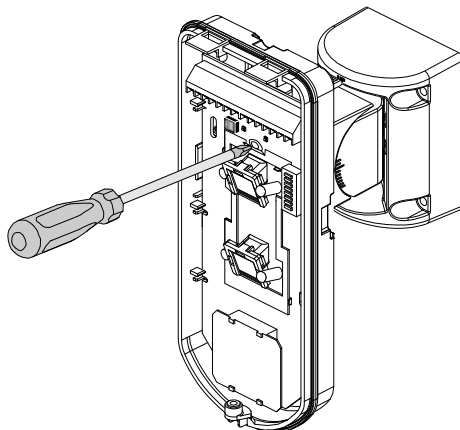
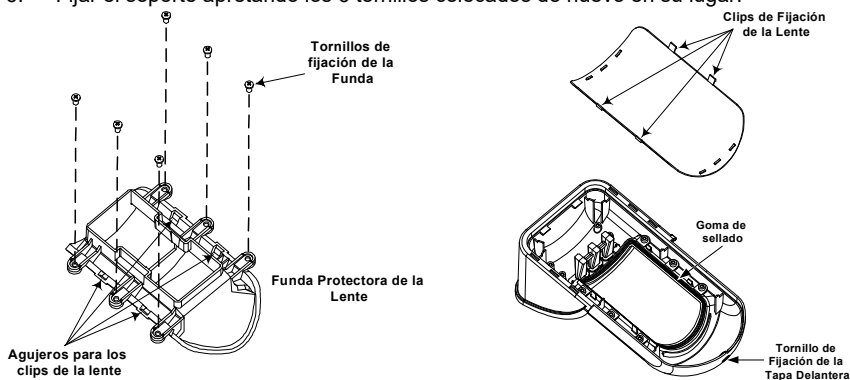

## Tipos de Lentes

### Lente gran angular (RL300) / Lente para instalación baja - Mascotas (RL300F) : Vista superior

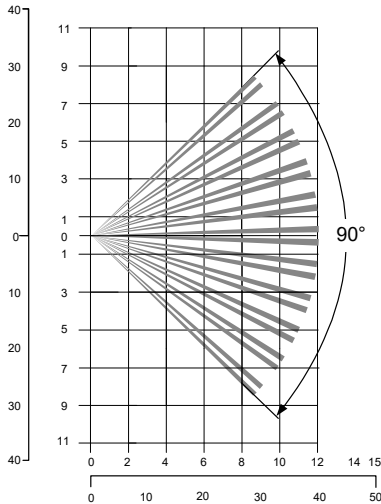

### Lente gran angular (RL300): Vista lateral

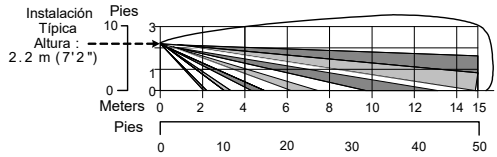

### Lente para instalación baja - Mascotas (RL300F) Vista lateral

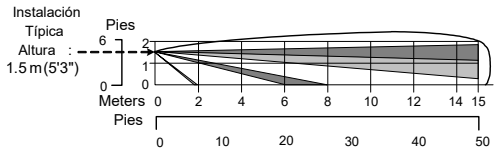

#### Nota:

La inmunidad del detector contra pequeños animales (depende de la altura del animal, sin límite de peso) es hasta 70cm (2'4"), cuando el detector se instala a 2.2m (7'2"). Si la instalación se realiza por debajo de la altura mencionada arriba, la inmunidad contra Mascotas disminuye proporcionalmente; cada reducción de 10cm (4") en la altura de la instalación conlleva una reducción de 10cm (4") en la Inmunidad a las Mascotas (altura del animal).

### Lente de largo alcance (RL300LR): Vista superior

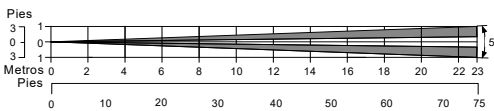

### Lente de barrera (RL300B): Vista superior

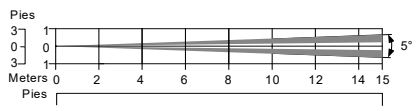

### Lente de largo alcance (RL300LR): Vista lateral

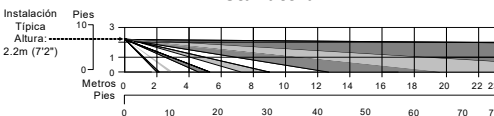

### Lente de barrera (RL300B): Vista lateral

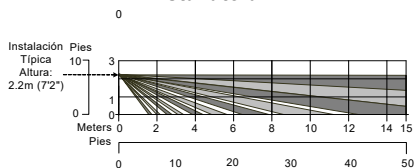

## Especificaciones Técnicas

<b>Eléctrica</b>	
Consumo de corriente	30mA a 12 VCC (en reposo)
	42mA a 12 VCC (máx. con LED ON)
Requisitos de voltaje	9 -16 VCC
Contactos de alarma	24 VCC, 0.1A
Contactos AM	24 VCC, 0.1A
Salida de polvo	Colector abierto 70mA máx.
Salida de alimentación	10.587GHZ: 10dbm Typ.
Frecuencia	10.587GHZ
<b>Física</b>	
Tamaño:	230 x 123 x 123mm
Longitud x Anchura x Profundidad	(8.7 x 4.5 x 4.85 in.)
Peso	0.632 Kg (1.4lb)
<b>Medioambiental</b>	
Inmunidad a RF	Según EN 50130-4
Temperatura de Operación/Almacenamiento	-30°C a 60°C (-22°F a 140°F)

\* La tecnología PIR se ve limitada en condiciones ambientales severas.

## Información para Pedidos

### Unidades Estándar

Modelo	Descripción
WatchOUT 315DT	WatchOUT DT + Rótula giratoria
<b>Nota:</b>	
Cada uno de los detectores contiene un soporte con rótula giratoria estándar y 3 lentes (Las referencias van grabadas en las mismas lentes): 1 lente para instalación en baja altura: 1.7m y anti-mascotas (RL300F), 1 lente de largo alcance (RL300R) y 1 lente de barrera (RL300B).	

### Kits de Accesorios

Modelo	Descripción	Peso
RA300B	Kit Rótula de Barrera para WatchOUT	0.1 Kg (0.23 lb)
RA300P	Kit Adaptador de Poste para WatchOUT	0.25 Kg (0.55 lb)
RA300C	Kit Adaptador de Conducto para WatchOUT	0.6 Kg (1.27 lb)
RA300SC	Rótula Adaptador de Conducto de Metal para WatchOUT	1Kg (2.2 lb)

### Opción de Cámara

Modelo	Descripción
WatchOUT VC1	Carcasa con adaptador de cámara para WatchOUT (Cámara no incluida)

## Instalación en Modo BUS

### Introducción

La información en esta sección se refiere únicamente a la instalación del WatchOUT 315DT en Modo BUS. Pueden instalarse hasta 32 detectores en el BUS RS485 de las centrales ProSYS, ahorrando tiempo de cableado y permitiendo control y diagnósticos remotos.

### Cableado de los terminales

<b>+,-</b>	Usado para la conexión de la fuente de alimentación de 12 VCC. Conecte el terminal (+) al AUX RED y el terminal (-) al COM BLK en los terminales de las centrales ProSYS.
<b>YELLOW</b>	Usado para comunicación de datos con las centrales ProSYS. Conecte el terminal al <b>BUS YEL</b> de las centrales ProSYS
<b>GREEN</b>	Usado para comunicación de datos con las centrales ProSYS. Conecte el terminal al <b>BUS GRN</b> de las centrales ProSYS
<b>TAMPER</b>	Usado para el cableado del tamper (véase más abajo)
<b>LED ENABLE</b>	Usado para el cableado del tamper (véase más abajo)
<b>Nota:</b>	
Todos los terminales que no se mencionan en la tabla de arriba, no se utilizan.	

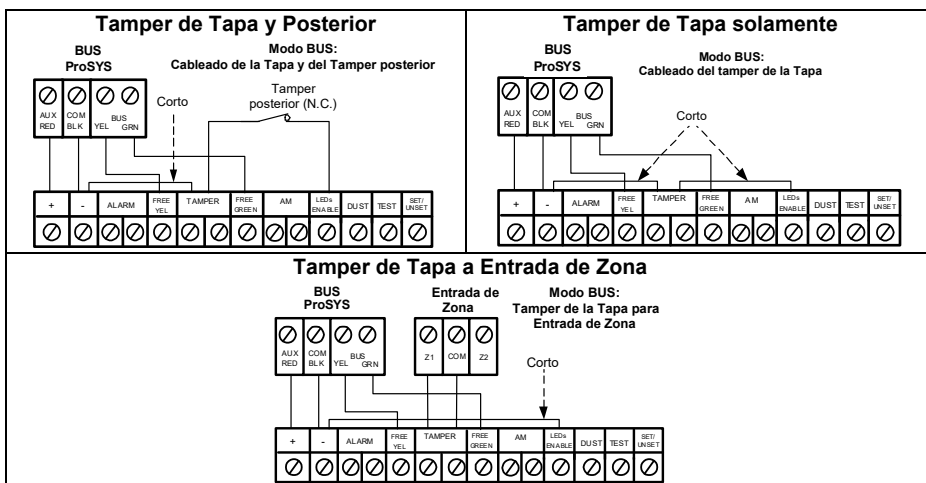

### Configuración de los interruptores DIP

Número del Interruptor DIP	Descripción
1 - 5	Usado para asignar el número de ID del detector. Establezca el número de ID de la misma manera que para cualquier otro accesorio de las centrales ProSYS (Ver manual de instalación de las centrales ProSYS)
6 - 8	Sin uso

## WatchOUT ID: Interruptores DIP 1 - 5

ID	1	2	3	4	5
01	OFF	OFF	OFF	OFF	OFF
02	ON	OFF	OFF	OFF	OFF
03	OFF	ON	OFF	OFF	OFF
04	ON	ON	OFF	OFF	OFF
05	OFF	OFF	ON	OFF	OFF
06	ON	OFF	ON	OFF	OFF
07	OFF	ON	ON	OFF	OFF
08	ON	ON	ON	OFF	OFF
09	OFF	OFF	OFF	ON	OFF
10	ON	OFF	OFF	ON	OFF
11	OFF	ON	OFF	ON	OFF
12	ON	ON	OFF	ON	OFF
13	OFF	OFF	ON	ON	OFF
14	ON	OFF	ON	ON	OFF
15	OFF	ON	ON	ON	OFF
16	ON	ON	ON	ON	OFF

ID	1	2	3	4	5
17	OFF	OFF	OFF	OFF	ON
18	ON	OFF	OFF	OFF	ON
19	OFF	ON	OFF	OFF	ON
20	ON	ON	OFF	OFF	ON
21	OFF	OFF	ON	OFF	ON
22	ON	OFF	ON	OFF	ON
23	OFF	ON	ON	OFF	ON
24	ON	ON	ON	OFF	ON
25	OFF	OFF	OFF	ON	ON
26	ON	OFF	OFF	ON	ON
27	OFF	ON	OFF	ON	ON
28	ON	ON	OFF	ON	ON
29	OFF	OFF	ON	ON	ON
30	ON	OFF	ON	ON	ON
31	OFF	ON	ON	ON	ON
32	ON	ON	ON	ON	ON

## Programación de las centrales ProSYS

La sección siguiente describe las opciones de programación adicionales añadidas al software de las centrales ProSYS, que conciernen a la configuración del WatchOUT DT como un detector en BUS. Un sistema de seguridad realizado con las centrales ProSYS puede llevar hasta 32 detectores detectores en BUS (16 detectores en la central ProSYS 16) y cada uno de ellos ocupará una zona en el sistema.

Es recomendable leer y comprender totalmente los Manuales de Instalación y de Usuario de las centrales ProSYS, antes de programar el WatchOUT.

### Notas:

El WatchOUT es compatible con el software de las ProSYS Versión 4.xx y superior.

El WatchOUT puede programarse a través del Software U/D a partir de la Versión 1.8 o superior.

Para una máxima estabilidad de funcionamiento, es mejor NO excederse en la distancia máxima eléctrica del cable del BUS de 300 metros máximo (1000 pies) al conectar el WatchOUT en BUS.

### Agregar / Suprimir el WatchOUT DT

El WatchOUT es parte de una nueva categoría de accesorios, de zonas en BUS. Por lo tanto, Agregar/Suprimir el WatchOUT es idéntico a cualquier otro accesorio con la siguiente excepción:

**Cada Detector de Zona BUS debe estar asignado a una Zona Regular o Convencional.**

Cualquier detector en BUS puede ser asignado a una zona física cableada o a una zona virtual.

**Zona Física:** Cualquier zona en la placa base PCB de las centrales ProSYS (zonas 1-8) o en un expansor de zonas cableadas (ZE08, ZE16).

**Zona Virtual:** Cualquier zona en un expansor de zona en BUS definida como BZ08 o BZ16.





### Notas:

Las zonas virtuales en BUS son rentables. Permiten ampliar sus zonas en el sistema sin agregar expansores físicos de zonas.

El expansor de zonas virtuales en BUS puede usarse solamente para detectores de zona en BUS.





Para agregar un expansor de zonas en BUS seleccione el tipo BZ08 o BZ16 al agregar un expansor de zonas (Tecla rápida [7][1][2]).

### 1. Para Agregar / Suprimir el WatchOUT DT

- Desde el menú de instalador entrar en el menú Agregar/Suprimir: Tecla Rápida [7][1][9][5] para detectores de Zonas BUS.
- Usar las teclas  /  o  /  para colocar el cursor sobre el número de ID de la Zona Bus al cual quiere asignar (o borrar) un detector.

**Nota:**

Asegúrese que el número físico de ID del detector es idéntico al número de ID que se seleccionó durante la programación.



- Colocar el cursor en el campo TIPO y usar la tecla  /  para seleccionar ODT15 para el detector WatchOUT DT.
- Pulsar  /  para confirmar.
- Repetir el proceso para los otros detectores en BUS.

**2. Asignar el WatchOUT DT a una Zona**



- En el menú principal del instalador, entrar en Zonas: opción Una a Una (Tecla rápida [2][1])
- Seleccionar el número de zona que se desea asignar al detector en BUS.

**Nota:**

Si se definió un Expansor de Zonas en BUS, seleccionar un número de zona para las zonas virtuales (definidas por el expansor de zonas en BUS).

- Definir Particiones, Grupos, Tipo de Zona y Sonido de Zona.
- En la categoría Terminación seleccionar [5] Zona BUS seguido por  / . Entonces aparecerá la siguiente pantalla:

```
Z:001 Conexión a:
ID:01 Tipo=ODT15
```

- Seleccionar el número de zona BUS para asignarla a la zona programada. El campo "tipo" se actualizará automáticamente al seleccionar la zona.
- Pulsar  / . La categoría BUCLE de RESPUESTA no es aplicable a una zona BUS y aparecerá la siguiente pantalla:



```
Z:001 Respuesta:
N/A - ZONA BUS
```

- Pulsar  / , asignar la etiqueta de texto a la zona y pulsar  / .

**3. Configurar los Parámetros del WatchOUT DT**

- Para acceder a la opción de configuración del WatchOUT pulsar [2][0][3] en el menú principal del instalador. Entonces aparecerá la siguiente pantalla:

```
B - ZONA PRMS:
ZONA# = 001 (M:ZZ)
```

- Seleccionar la zona a la cual se asignó la zona BUS y presione  / . Ahora puede programar los parámetros del WatchOUT como se indica a continuación:

**Zonas Varios: Zona BUS**

Teclas Rápidas	Parámetros	Predeterminado
[2][0][3][zzz][1]	<b>LEDs</b>	<b>3 LEDs</b>
	Define el modo de operación de los LEDs.	
[2][0][3][zzz][1][1]	<b>Off</b>	
	Desactiva el funcionamiento de los LEDs.	
[2][0][3][zzz][1][2]	<b>Solamente Rojo</b>	
	Sólo funcionará el LED Rojo. Esta opción es altamente recomendable para evitar la posibilidad de que el intruso "Aprenda" el comportamiento del detector.	
[2][0][3][zzz][1][3]	<b>3 LEDs</b>	
	Funcionarán todos los LEDs.	
[2][0][3][zzz][2]	<b>Sensibilidad PIR</b>	<b>Normal</b>
	Define la sensibilidad del detector (MW + PIR)	



Teclas Rápidas	Parámetros	Predeterminado
[2][0][3][zzz] [2][1]..[4]	<b>Opciones de Sensibilidad</b> 1) Baja                    3) Normal 2) Media                4) Alta	
[2][0][3][zzz] [3]	<b>Alcance del MW</b> Define el alcance del canal de microondas. El alcance máximo es 23m.	<b>Trimmer (potenciómetro)</b>
[2][0][3][zzz] [3][1]..[7]	<b>Opciones del Alcance del MW</b> 1) Mínimo            3) 40%            5) 80%            7) Trimmer (el MW es 2) 20%                4) 60%            6) Máximo        definido por la configuración del potenciómetro en el PCB)	
[2][0][3][zzz] [4]	<b>Sensibilidad Anti-Enmascaramiento</b> Define la sensibilidad del AM por IR Activo.	<b>Sensibilidad Baja</b>
[2][0][3][zzz] [4][1]..[2]	<b>Opción de sensibilidad del Anti-Enmascaramiento</b> 1) Sensibilidad Alta    2) Sensibilidad Baja	
[2][0][3][zzz] [5]	<b>Tipo de Lente</b> Define la lente concreta del detector.	<b>Gran Angular</b>
[2][0][3][zzz] [5][1]..[2]	<b>Opciones de Tipo de Lente</b> 1) Gran Angular    2) Barrera / Largo Alcance	
[2][0][3][zzz] [6]	<b>Anti-Enmascaramiento</b> Define la función de detección de Anti-Enmascaramiento	<b>Activado</b>
[2][0][3][zzz] [6][1]..[2]	<b>Opciones de Anti-Enmascaramiento</b> 1) Desactivado    2) Activado (Predeterminado)	
[2][0][3][zzz] [7]	<b>Armar/Desarmar</b> Define la forma de trabajo del LED anti-enmascaramiento mientras el detector esté armado.	<b>No</b>
[2][0][3][zzz] [7][1]	<b>No</b> El AM (Anti-Enmascaramiento) por IR Activo y el AM de Proximidad están activados. Los LEDs actúan según la definición de los parámetros de los LEDs	
[2][0][3][zzz] [7][2]	<b>Sí</b> El AM (Anti-enmascaramiento) por IR Activo y el AM de Proximidad están desactivado Los LEDs están desactivados	
[2][0][3][zzz] [8]	<b>AM de Proximidad</b> Define la función de detección de Anti-Enmascaramiento de Proximidad.	<b>Desactivado</b>
[2][0][3][zzz] [8][1]..[2]	<b>Opciones de AM de Proximidad</b> 1) Desactivado (Predeterminado) 2) Activado NOTA: Desabilite el AM de proximidad durante una lluvia intensa (si el WatchOUT 315DT esta a la intemperie) para prevenir alertas de Proximidad AM.	









## Parámetros del Sistema

### Sistema: Control del Sistema

Teclas Rápidas	Parámetros	Predeterminado
[1][2][36]	<b>IR AM=Tamper</b> Usado para determinar la indicación de la detección de Anti-Enmascaramiento Sí: La alarma de Anti-enmascaramiento activará la salida del tamper. No: La alarma de Anti-enmascaramiento se considerará como un evento de problema.	<b>No</b>
[1][2][37]	<b>Prox AM =Tamper</b> Utilizado para determinar el funcionamiento del Anti-Enmascaramiento de Proximidad. Sí: El Anti-enmascaramiento de Proximidad activará la alarma de tamper. No: El Anti-Enmascaramiento de Proximidad será considerado como un evento de problema.	<b>No</b>

### Diagnósticos

Las centrales ProSYS permiten chequear los parámetros que reflejan el funcionamiento del detector.

- Desde el menú principal de usuario pulsar  [4] para acceder al menú Mantenimiento.
- Introducir el código de Instalador (o sub-instalador) y pulsar  / .
- Pulsar las teclas [9] [1] para el menú diagnóstico de Zonas BUS.
- Introducir el dígito de la zona que se quiere chequear y pulsar  / . El sistema realizará la prueba de diagnóstico y aparecerá una lista de parámetros, según se indica en la tabla abajo.
- Usar las teclas  /   /  para ver los resultados de la prueba de diagnóstico.

### Menú Usuario: 4) Mantenimiento → 9) Diagnóstico → 1) Zona BUS

Teclas Rápidas	Parámetro
[4][9][1][zzz]	<b>Voltaje de Entrada del Detector:</b> Indica el voltaje de entrada en el detector. <b>PIR 1 Nivel:</b> Canal PIR 1 nivel CC. Rango 0.1V - 4V <b>PIR 1 Nivel de Ruido:</b> Canal PIR 1 nivel CA. Rango 0VAC (Sin ruido) - 4VA <b>PIR 2 Nivel:</b> Canal PIR 2 nivel CC. Rango 0.1V - 4V <b>PIR 2 Nivel de Ruido:</b> Canal PIR 2 nivel CA. Rango 0VAC (Sin ruido) - 4VA <b>MW 1 Nivel:</b> Canal MW 1 nivel CC. Rango 0.1V - 4V <b>MW 1 Nivel de Ruido:</b> Canal MW 1 nivel CA. Rango 0VAC (Sin ruido) - 4VA <b>MW 2 Nivel:</b> Canal MW 2 nivel CC. Rango 0.1V - 4V <b>MW 2 Nivel de Ruido:</b> Canal MW 2 nivel CA. Rango 0VAC (Sin ruido) - 4VA

<b>Détecteur extérieur WatchOUT 315DT : Installation en mode Relais</b> .....	<b>52</b>
<b>Introduction</b> .....	<b>52</b>
<b>Montage</b> .....	<b>52</b>
Conditions de montage.....	52
Changement de position de l'autoprotection arrière.....	54
<b>Câblage de la borne de connexion</b> .....	<b>54</b>
<b>Réglage des micro-interrupteurs DIP</b> .....	<b>55</b>
<b>Installation de la rotule standard</b> .....	<b>56</b>
Installation murale.....	56
Montage du conduit de la rotule .....	57
<b>Remplacement des lentilles</b> .....	<b>59</b>
Types de lentilles .....	60
<b>Spécifications techniques</b> .....	<b>61</b>
<b>Information Catalogue</b> .....	<b>61</b>
<b>Appareils Standard</b> .....	<b>61</b>
<b>Détecteur extérieur WatchOUT 315DT : Installation en mode BUS</b> .....	<b>62</b>
<b>Introduction</b> .....	<b>62</b>
<b>Câblage du bornier</b> .....	<b>62</b>
<b>Programmation de la ProSYS</b> .....	<b>63</b>
<b>Paramètres Système</b> .....	<b>66</b>

# Détecteur extérieur WatchOUT 315DT (Double Technologie) :

## Installation en mode Relais



### Introduction

Le détecteur extérieur WatchOUT 315DT, de RISCO Group est un détecteur unique en son genre, doté d'un traitement de signaux qui repose sur deux canaux à infrarouge passif (IRP) et deux canaux HyperFréquences (HF). Le détecteur peut fonctionner soit comme détecteur relais normal relié à n'importe quelle centrale de commande, soit comme accessoire BUS s'il est connecté à la centrale ProSYS de RISCO Group par le BUS RS485, lui conférant ainsi des capacités exceptionnelles de contrôle et diagnostique à distance.

Les instructions ci-dessous décrivent l'installation du WatchOUT 315DT en mode Relais. Pour plus de détails sur l'installation en mode BUS, veuillez vous reporter aux instructions correspondantes.

### Montage

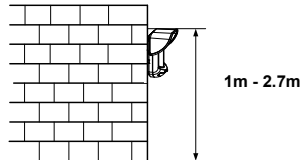
#### Conditions de montage

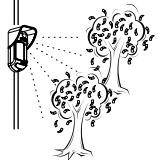
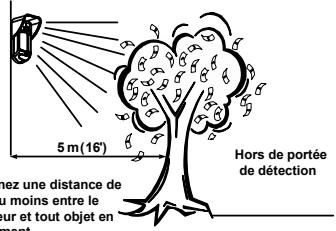
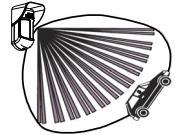
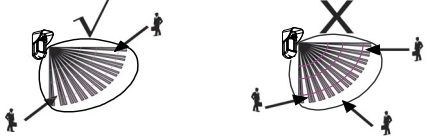
 <p>Hauteur optionnelle : 1m – 2.7m Hauteur caractéristique : 2.2m Lentille installée par défaut : grand angle 15m 90°</p> 	 <p>Si possible, évitez d'orienter le détecteur vers des objets en mouvement (buissons, arbres aux branches oscillantes etc.)</p>
<p><b>Remarque :</b></p> <ol style="list-style-type: none"> <li>1. Pour les installations à faible hauteur, en dessous de 1,7m nécessitant l'immunité aux animaux domestiques, utilisez la lentille RL300F fournie (pour installations sur clôture ou mur de faible hauteur).</li> <li>2. L'immunité du détecteur aux animaux domestiques (caractérisée par la taille d'un animal, sans limitation de poids), va jusqu'à 70 cm pour une installation du détecteur à 2,2m. En cas d'installation en dessous de la hauteur susmentionnée, l'immunité aux animaux domestiques se réduit en conséquence ; chaque abaissement de 10 cm réduit de 10 cm l'immunité aux animaux domestiques.</li> </ol>	 <p>Maintenez une distance de 5m au moins entre le détecteur et tout objet en mouvement</p> <p>Assurez-vous qu'aucun objet n'obstrue le champ de vision des deux technologies. Prêtez attention aux buissons ou arbres en pleine croissance, aux plantes aux grandes feuilles souples, etc...</p>
<p>Pour les installations exposées au grand trafic de véhicules ou ayant des objectifs au-delà de la portée de détection requise, il est recommandé de régler la sensibilité micro-ondes ou HF et/ ou d'incliner le détecteur vers le bas.</p> <p><b>Remarque :</b> L'inclinaison du détecteur vers le bas est susceptible de réduire l'immunité aux animaux domestiques.</p>	
<p>Pour obtenir une capacité maximale de détection, choisissez un endroit susceptible de capter le passage de tout intrus dans la zone couverte par les rayons à 45°.</p>	
<p><b>NOTE:</b> Désactiver l'AM de proximité lors de fortes pluies (si le WatchOUT 315DT n'est pas à l'abri de la pluie) pour éviter les alertes d'AM de proximité.</p>	

## Installation murale

### Remarque :

Pour faciliter l'installation, les pastilles pré-perçées prévues à cet effet sont numérotées sur la paroi arrière de l'appareil.

- Ouvrez le couvercle du WatchOUT (dévisez en C1, figure 1).
- Dégagez le socle interne (dévisez en I1, figure 2).
- Choisissez le mode d'installation comme suit

### Montage à plat :

- Percez les pastilles pré-perçées du socle externe (figure 3).
  - B1-B4 : pastilles pré-perçées pour assemblage mural.
  - T1 : pastille pré-perçée de l'autoprotection arrière.
  - W2 / W3 : entrées pré-perçées pour fils électriques.

### Montage à 45° (montage sur côté gauche)

- Percez les pastilles pré-perçées du socle externe (figure 3).
  - L1, L2 : pastilles pré-perçées pour montage à gauche
  - T3 : pastille pré-perçée de l'autoprotection arrière.
  - W5 / W6 : entrées pré-perçées pour fils électriques
- Retirez le ressort de l'autoprotection.
- Remplacez le crochet d'autoprotection 1 par le crochet d'autoprotection plat fourni 2.



- Insérez la languette d'autoprotection B aux endroits marqués T5 et T3, ensuite serrez la vis A (figure 3).
- Introduisez les fils électriques extérieurs par le socle externe en W2, W3. (figure 3).
  - Fixez le socle externe de l'appareil au mur.
  - Faites passer les fils électriques externes et d'autoprotection dans le socle interne (figure 4).
  - Fixez le socle interne au socle externe (bloquez en I1, figure 2).
  - Fermez le couvercle (bloquez en C1, Figure 1) après avoir câblé et réglé les micro-interrupteurs DIP.
  - Effectuez un test de passage avec le détecteur.

Figure 1

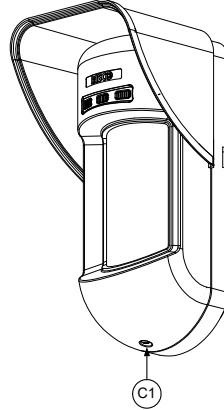

Figure 2

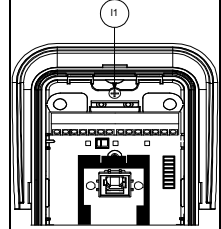

Figure 3

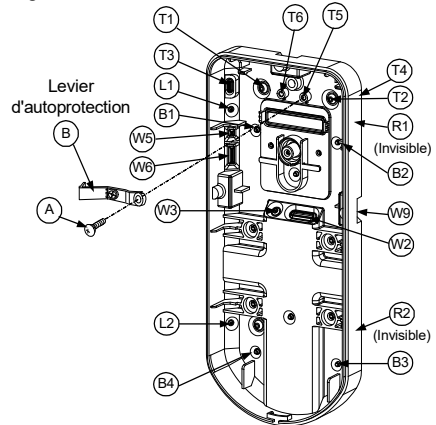
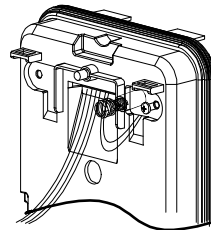

Figure 4



### Remarque :

Pour une installation à 45° sur côté droit, utilisez les pièces équivalentes du socle externe comme suit :

Désignation des pastilles pré-perçées	Gauche	Droit
Pastilles pré-perçées pour montage	L1, L2	R1, R2
Pastilles pré-perçées du ressort de l'autoprotection	T1, T3	T2, T4
Vis de montage de l'autoprotection	T5	T6

## Changement de position de l'autoprotection arrière

L'autoprotection arrière est, par défaut, fixée sur le côté droit du socle interne (vue arrière). Si vous souhaitez la déplacer sur le côté gauche (vue arrière), procédez comme suit (Figure 5) :

1. Retirez la vis d'autoprotection 1 pour dégager l'autoprotection de la position 7.
2. Assurez-vous que le ressort de l'autoprotection 2 repose bien sur la base de câblage 4 de l'autoprotection.
3. Vérifiez que le crochet en plastique 3 de l'autoprotection repose bien sur les points 2 et 4.
4. Serrez la vis d'autoprotection 1 dans la pièce 3 en la faisant passer par la position 6.

Figure 5

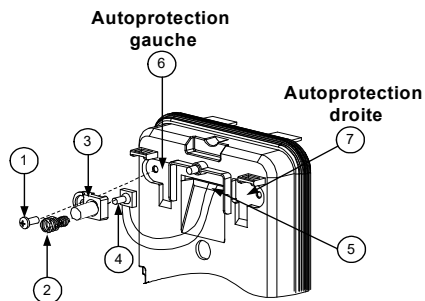

### Remarques:

1. Vous entendrez un "Clic" en fixant le ressort de l'autoprotection au mur.
2. Pour l'installation sur un mât, l'autoprotection peut être déplacée vers le côté inférieur droit du socle interne.

## Câblage du bornier

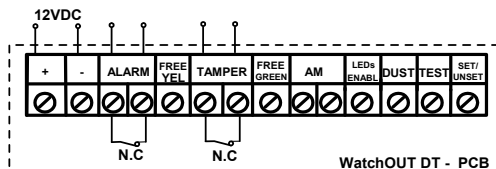

<b>+, -</b>	12 VCC
<b>ALARM</b>	Relais d'alarme N.F, 24VCC, 0,1A
<b>FREE YEL</b>	Broche libre pouvant servir à connecter les fils électriques et résistances EOL.
<b>TAMPER</b>	Relais d'autoprotection N.F, 24VCC, 0,1A
<b>FREE GREEN</b>	Broche libre pouvant servir à connecter les fils électriques et résistances.
<b>AM</b>	Sortie relais AM normalement fermée (24VCC, 0,1A) indiquant une alarme Anti-Masque ou une panne quelconque du détecteur (sauf présence de poussière ou impuretés sur la lentille). L'AntiMasque de proximité permet d'alerter d'un sabotage avant que le détecteur ne soit endommagé ou masqué, utilisant les deux canaux hyperfréquences.
	<b>Remarque :</b> AM de Proximité: Quand le DIP 8 est défini comme actif, ce relais s'ouvre aussi quand une tentative AM de Proximité se produit. Dans ce cas, le relais restera ouvert pendant au moins 20 secondes et sera fermé suite à la détection de mouvement.
<b>LEDs ENABL</b>	Pour le contrôle à distance des diodes LED quand le micro-interrupteur DIP1 est en position de marche (ON). LED Activée : alimentation +12V OU pas de connexion de la borne de connexion LED Désactivée : mettre la borne à 0V.
<b>DUST</b>	N/A
<b>TEST</b>	Pour effectuer un test d'alarme déclenché à distance par le détecteur, en appliquant 0 volt sur cette borne. Succès du test : le relais d'alarme est momentanément ouvert. Echec du test : le relais AM est ouvert.
<b>SET/ UNSET</b>	Cette entrée permet de contrôler le fonctionnement de l'Anti- Masque et des diodes LED selon l'état du système, Activ. (Arm.) / Désact. (Désarm.).

Lorsque le système est armé, cette caractéristique empêche un éventuel intrus de pouvoir connaître l'état du détecteur et désactive la détection Anti-Masque.

Etat système	Entrée état	Relais AM	Diodes LED
Activ. (Arm.)	0V	Off	Off
Désactiv. (Désarm.)	12V ou pas de connexion	On*	On**

\* Le DIP7 est en position de marche - ON (Anti-masque activé).

\*\* Le DIP1 est en position de marche - ON (Diodes LED activées) et la borne d'accès LED ACTIVE est activée (+12V OU pas de connexion de la borne).

## Réglage des micro-interrupteurs DIP

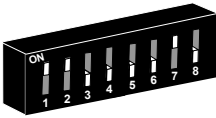

Réglage d'usine par défaut

**DIP 1** : fonctionnement des LED.

On : diodes LED activées.

Off : diodes LED désactivées

**DIP 2-3** : sensibilité de détection

Sensibilité	DIP2	DIP3
Faible	Off	Off
Moyenne	Off	On
Normale (par défaut)	On	Off
Maximum*	On	On

\* En sensibilité maximum, l'option de reconnaissance des objets oscillants est désactivée pour une sensibilité optimale.

**DIP 4** : sensibilité Anti-masque

On : Elevé

Off : Faible

**DIP 5** : optique du détecteur

On : Barrière / Longue portée

Off : grand angle

**DIP 6** : diode LED rouge/ 3 LED

On : diode LED rouge seulement.

Off : 3 diodes LED

**DIP 7** : fonctionnement Anti-masque

On : Activé

Off : Désactivé

**DIP 8** : Anti-masque de Proximité

On : Activé

Off : Désactivé

## Réglage des micro-ondes / Hyper Fréquences

Réglez la couverture de l'Hyper Fréquence à l'aide du potentiomètre qui se trouve sur la carte PCB.

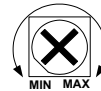

## Test de passage

Deux minutes après la mise sous tension, effectuez un test de passage dans la zone protégée afin de vérifier le bon fonctionnement de l'installation.

En cas d'installation sur des surfaces inégales, faites glisser la carte PCB à l'intérieur du socle interne en effectuant le réglage qui convient à la hauteur souhaitée (1,0m, 1,5m, 2,2m, 2,7m) .

Pour réduire la portée de détection, faites glisser la carte PCB vers le haut ou inclinez le pivot vers le bas.

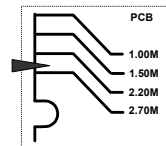

## Affichage à diodes LED

LED	État (allumage)	Description
JAUNE	Continu	Désigne une détection IRP.
	Clignotant	Désigne une détection AM (Anti-masquage).
VERT	Continu	Désigne une détection HF.
	Clignotant	Indique une détection AM de Proximité.
ROUGE	Continu	Indique une ALARME.
	Clignotant	Indique un dysfonctionnement dans la communication avec la ProSYS (en mode BUS seulement).
Toutes les diodes LED	Clignotant (l'une après l'autre)	Initialisation de l'appareil à la mise sous tension.

## Remarques:

1. Le micro-interrupteur DIP 1 doit se trouver en position ON pour permettre les indications LED.
2. Une seule diode LED est active à la fois. Par exemple, si les deux canaux de détection IRP et HF sont en fonction, seule la diode jaune ou seule la diode verte s'affichera en allumage constant (selon celui des deux canaux qui aura détecté l'évènement en premier), suivie par la LED d'alarme rouge.
3. Pour prévenir l'analyse par un intrus potentiel des technologies de détection comme l'Alarme, l'Anti-Masque et l'Anti-Masque de Proximité, placez le contact DIP Switch 6 (SW1) sur ON. Ainsi, seule la LED rouge sera activée.

## Cavalier Mode Relais / Mode BUS

Le cavalier J-BUS (situé sur la carte PCB entre les diodes LED rouge et verte) sert à déterminer le mode de fonctionnement du détecteur comme suit :

Mode  
Relais



Mode BUS



## Installation de la rotule standard

Le Détecteur Extérieur est livré avec une rotule standard permettant une installation flexible. Pour l'intégrer à l'installation du détecteur, veuillez suivre les instructions ci-dessous :

1. Ouvrez le couvercle du WatchOUT (débloquez en C1, Figure1).
2. Dégagez le socle interne (débloquez en I1, Figure2).
3. Percez les entrées pré-perçées du socle externe (Figure 7, Détail B)
  - W1: pastille pré-perçée pour le passage du fil électrique.
  - S1, S2 : pastilles pré-perçées pour la fixation du socle externe à la rotule standard.
  - S3: pastille pré-perçée pour la vis de fixation du socle externe.
4. Retirez de la rotule la pastille requise pour son branchement électrique S2, S7 ou S9 (Figure 7, Détail A).
5. Retirez l'autoprotection arrière du socle interne (cf. § "Changement de position de l'Autoprotection arrière") et reliez-la au point S5 (Figure 7, Détail A) de la rotule standard.

## Remarque :

Assurez-vous de voir la marque **UP** gravée sur la face supérieure de la rotule.

6. Choisissez le mode de montage comme suit :

### Installation murale

- a. Introduisez les fils électriques externes à travers les pastilles pré-perçées S2, S7 ou S9 et faites-les ressortir (y compris les fils de l'autoprotection) par le passage de la rotule prévu à cet effet (Figure 7, Détail B).
- b. Fixez la rotule au mur en passant par les entrées S1, S3, S6 et S8.



## Remarques pour installation INCERT:

1. Après installation du support orientable, remplacer (au choix) 2 des 4 vis de fixation du support orientable par 2 vis indémontables.
2. Pour l'installation en mode barrière, remplacer les 2 vis de fixation du support par 2 vis indémontables.
3. **Contactez votre distributeur local pour obtenir le kit de vis spéciales:**
  - RABNRAK3200A Kit de vis spéciales pour support standard
  - RABNRA300B0A Kit de vis spéciales pour support barrière



## Montage du conduit de la rotule

(à l'aide de l'adaptateur rotule métallique pour conduit - CSMA) (Figure 7, Détail A)

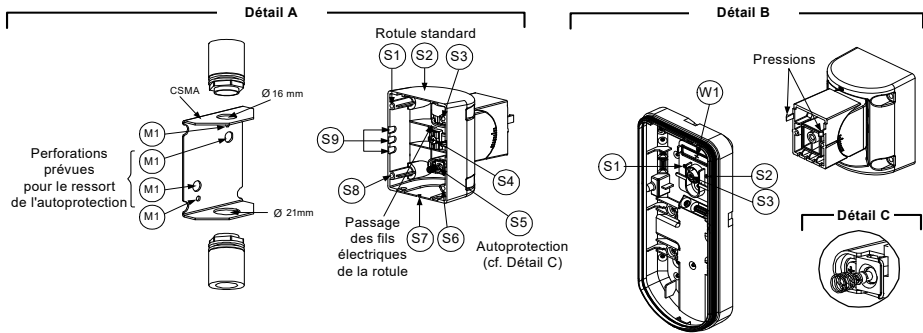

Figure 7

### Remarque :

Le CSMA est nécessaire en cas d'utilisation de fils électriques extérieurs au mur, ce qui requiert une bonne protection de la gaine les contenant. Il doit être commandé séparément sous la référence : P/N RA300SC0000A.

- Choisissez la direction dans laquelle vous voulez monter le CSMA, en fonction du diamètre voulu : 16mm ou 21mm.
- Introduisez le conduit dans le CSMA.
- Fixez le CSMA au mur, en passant par les points (M1, M4).
- Insérez les câbles externes et les fils électriques de l'autoprotection en partant du conduit et en passant par le passage de la rotule prévu à cet effet (Figure 7, Détail A).
- Fixez la rotule au mur en utilisant les entrées S1, S3, S6 et S8.



### Remarques pour installation INCERT:

- Après installation du support orientable, remplacer (au choix) 2 des 4 vis de fixation du support orientable par 2 vis indémontables.
- Pour l'installation en mode barrière, remplacer les 2 vis de fixation du support par 2 vis indémontables.
- Contactez votre distributeur local pour obtenir le kit de vis spéciales:**  
RABNRAK3200A Kit de vis spéciales pour support standard  
RABNRA300B0A Kit de vis spéciales pour support barrière

### Remarque :

Le ressort de l'autoprotection S5 (figure 7) doit toucher le mur à travers les entrées prévues à cet effet M2 ou M3 dans le CSMA. Assurez-vous d'entendre un "clic" venant de l'autoprotection lorsque vous l'accrochez au mur.

- Insérez les fils électriques de l'autoprotection ainsi que les câbles externes en partant de la rotule standard et en passant par la pastille pré-percée W1 du socle externe (Figure 7, Détail B).
- Fixez le socle externe à la rotule à l'aide de deux vis passant par les pastilles (pressions) correspondantes (Figure 8).

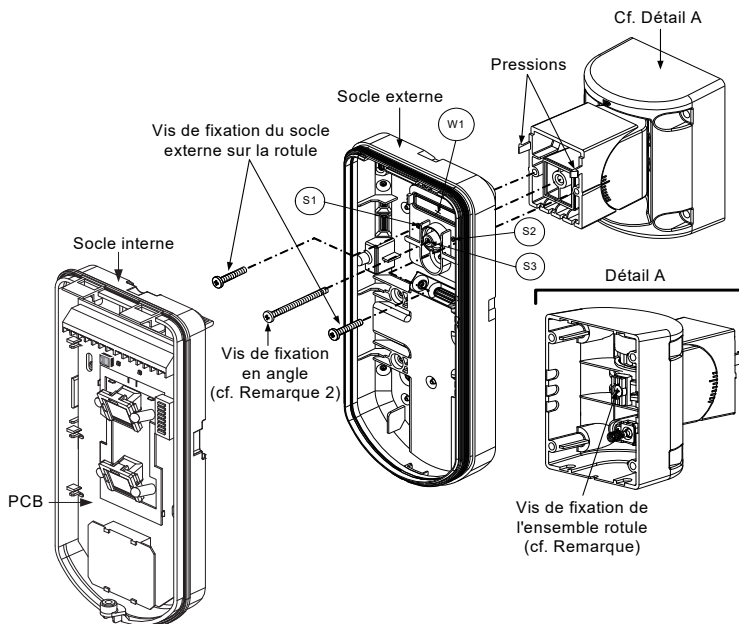

Figure 8

**REMARQUE :**

Ne serrez ni desserrez la vis de connexion de la rotule car elle sert seulement à assembler les pièces.

9. Fixez le socle externe à la rotule à l'aide de deux vis passant par les pastilles pré-perçées S1 et S2 (Figure 7).
10. Introduisez la vis de fixation d'angle fournie en partant du socle externe et en passant par la pastille pré-perçée S3 de la vis de fixation d'angle, située sur le socle externe, pour atteindre la rotule standard (Figure 7).
11. Inclinez et faites tourner la rotule standard jusqu'à obtenir la position que vous souhaitez lui donner. Dès cette position obtenue, serrez la vis de fixation d'angle.
12. Alignez le socle interne avec le socle externe. Insérez tous les fils électriques par le socle interne.
13. Fixez le socle interne au socle externe (bloquez I1, Figure 2).
14. Pour rajuster la rotule standard lorsque la carte PCB est installée (Figure 8):
  - a. Abaissez la mousse noire qui se trouve en dessous de la diode ROUGE sur la carte PCB (suffisamment pour atteindre la vis de fixation de la rotule).
  - b. A l'aide d'un tournevis Philips, desserrez la vis de fixation (cf. Figure 8).
  - c. Inclinez et/ ou faites tourner le pivot standard jusqu'à obtenir la position voulue.
  - d. Serrez la vis de fixation d'angle.

**Remarque :**

Lorsque les marques indiquées sur les pièces mobiles sont bien alignées (Figure 8), la rotule standard se trouve à 0° en position verticale/ horizontale. Chaque cran à partir de cette position correspond à une inclinaison verticale / horizontale de 5°.

15. Refermez le couvercle (bloquez C1, Figure 1) et effectuez un test de passage avec le détecteur.

**Remarque :**

La vis doit traverser le socle externe pour finalement se fixer à la rotule.

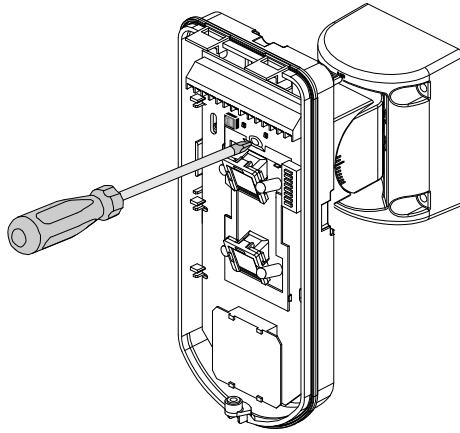
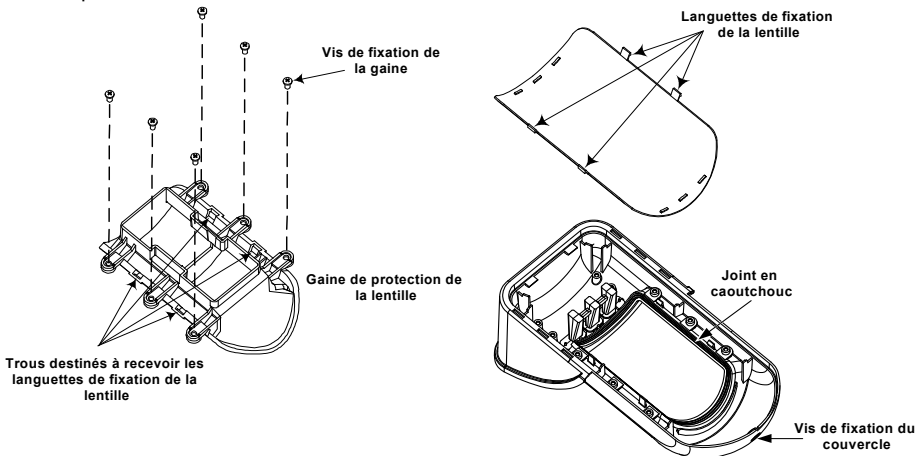

Figure 8

## Remplacement des lentilles

1. Desserrez les six vis qui fixent la gaine de maintien de la lentille à l'envers du couvercle.
2. Pour enlever cette gaine de protection, poussez délicatement la lentille depuis l'extérieur du couvercle.
3. Séparez la lentille de la gaine en poussant délicatement les crochets qui la retiennent à celle-ci.
4. Remplacez la lentille. Placez les 4 languettes de fixation de la lentille dans les trous correspondants de la gaine.
5. Réinsérez la gaine de protection à sa place sur le couvercle. Veillez à ce qu'elle couvre le joint en caoutchouc.
6. Remplacez et resserrez les 6 vis de fixation.



## Types de lentilles

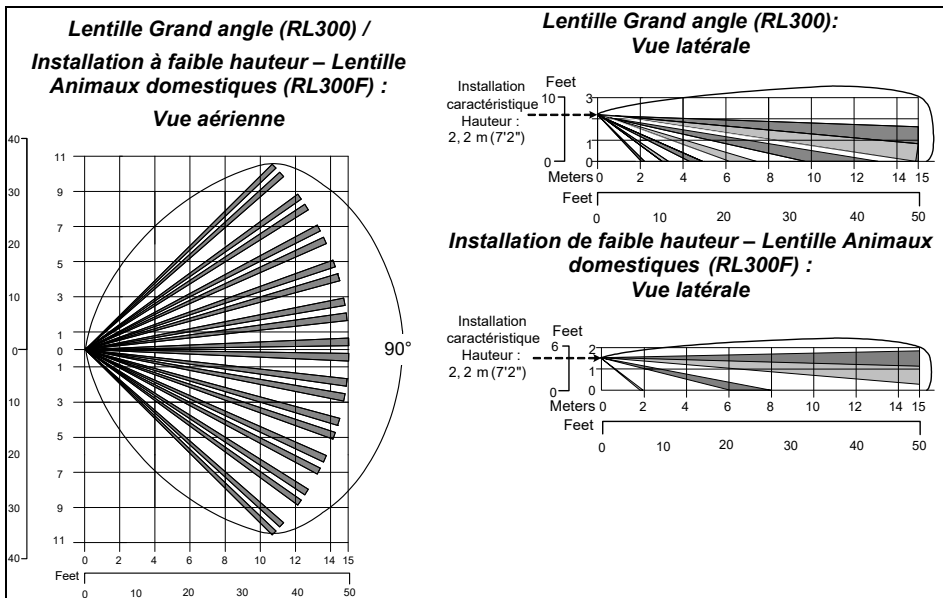

### Remarque:

L'immunité du détecteur aux animaux domestiques (caractérisée par la taille d'un animal, sans limitation de poids), va jusqu'à 70 cm pour une installation du détecteur à 2,2m. En cas d'installation en dessous de la hauteur susmentionnée, l'immunité aux animaux domestiques se réduit en conséquence ; chaque abaissement de 10 cm réduit de 10 cm l'immunité aux animaux domestiques.

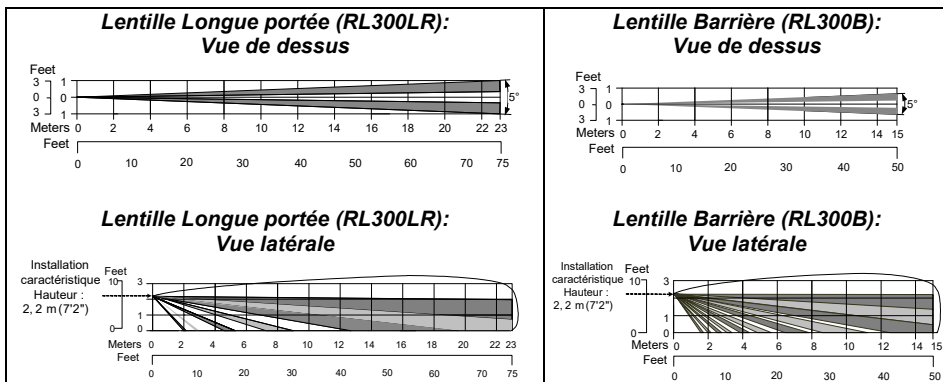

### Remarques pour installation INCERT:

1. Les distances de détection proposées sont seulement valables lorsque le détecteur est réglé sur la sensibilité Maximum.
2. Pour les autres réglages de sensibilité, confirmer les distances de détection lors de l'installation (tests de passage).

## Spécifications techniques

Caractéristiques électriques	
Consommation électrique	30mA à 12 VCC (en veille)
	42mA à 12 VCC (max. avec diodes LED allumées)
Conditions de tension requises	9 -16 VCC
Contacts d'alarme	24 VCC, 0.1A
Contacts AM	24 VCC, 0.1A
Sortie poussière (DUST)	Collecteur ouvert 70mA max
Puissance disponible	10.587GHZ: 10dbm Typ.
Fréquence	10.587GHZ
Caractéristiques physiques	
Dimensions : L x l x P	230 x 123 x 123mm
Poids	0,632 Kg
Caractéristiques environnementales	
Immunité RF	Répond à la norme EN50130-4
Température de fonctionnement/ stockage	De -30°C à 60°C

\* La technologie IRP est limitée dans des conditions environnementales difficiles.

## Information Catalogue

### Appareils Standard

Modèle	Description
WatchOUT 315DT	WatchOUT DT + rotule
<b>Remarque:</b>	
Chaque détecteur est livré avec une rotule de fixation standard et 3 lentilles de remplacement (S/N gravés sur les lentilles) : installation basse (<1,7m) avec immunité aux animaux (RL300F), longue portée (RL300LR) et barrière (RL300B).	

### Sets d'accessoires

Modèle	Description	Poids
RA300B	Set rotule Barrière	0,1 Kg
RA300P	Ensemble adaptateur Mât	0,25 Kg
RA300C	Ensemble adaptateur Conduit	0,6 Kg
RA300SC	Adaptateur rotule métallique pour conduit	1Kg
RA300HS	Boîtier Démo	- -

### Accessoires pour caméras

Modèle	Description
WatchOUT VC1	Adaptateur de couvercle pour caméra
WatchOUT VC053	Caméra grand angle pour WatchOUT
WatchOUT VC017	Caméra à champ étroit pour WatchOUT
WatchOUT VCPS	Alimentation pour caméra 220VCA
WatchOUT VCPS	Alimentation pour caméra 120VCA

## Détecteur extérieur WatchOUT 315DT : Installation en mode BUS

### Introduction

L'information communiquée dans ce document concerne exclusivement l'installation du WatchOUT 315DT en mode BUS. Jusqu'à 32 détecteurs BUS peuvent être installés sur le Bus RS485 de la ProSYS, permettant ainsi un gain de temps au niveau de l'installation électrique et garantissant un contrôle à distance et la réalisation de diagnostics.

### Câblage du bornier

<b>+, -</b>	Pour le branchement d'une alimentation électrique de 12VCC. Reliez le pôle (+) aux AUX RED (rouges) et le pôle (-) au COM BLK (noires) des bornes de la ProSYS.
<b>YELLOW</b>	Pour la transmission de données avec la ProSYS. Reliez la borne au <b>BUS YEL</b> (jaune) de la ProSYS.
<b>GREEN</b>	Pour la transmission de données avec la ProSYS. Reliez la borne au <b>BUS GRN</b> (vert) de la ProSYS.
<b>AUTOPR. (TAMPER)</b>	Pour l'installation électrique assurant la détection de l'autoprotection, cf. ci-dessous.
<b>LED ACTIVE (LED ENABLE)</b>	Pour l'installation électrique assurant la détection de l'autoprotection, cf. ci-dessous.

### Remarque :

Toutes bornes non mentionnées dans le tableau ci-dessous sont inutilisées.

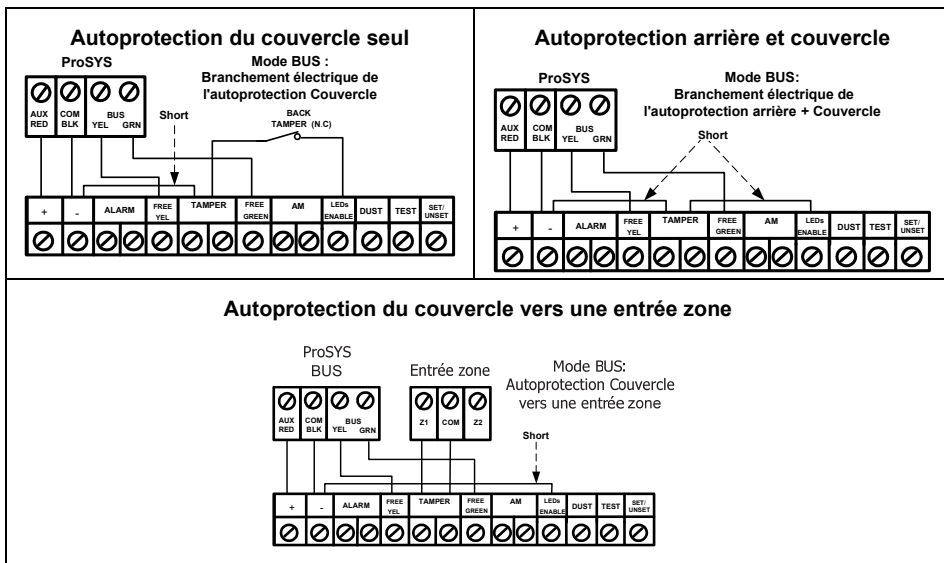

### Réglages des micro-interrupteurs (DIP)

N° d'interrupteur DIP	Description
1 - 5	Sert à régler le numéro d'identification (ID) du détecteur. Pour ce faire, procédez de la même façon qu'avec tout autre accessoire de la ProSYS. (Veuillez vous reporter au guide d'installation de la ProSYS).
6 - 8	Inutilisés.

## Numéro ID WatchOUT : Micro-interrupteurs DIP 1 - 5

ID	1	2	3	4	5	ID	1	2	3	4	5
01	OFF	OFF	OFF	OFF	OFF	17	OFF	OFF	OFF	OFF	ON
02	ON	OFF	OFF	OFF	OFF	18	ON	OFF	OFF	OFF	ON
03	OFF	ON	OFF	OFF	OFF	19	OFF	ON	OFF	OFF	ON
04	ON	ON	OFF	OFF	OFF	20	ON	ON	OFF	OFF	ON
05	OFF	OFF	ON	OFF	OFF	21	OFF	OFF	ON	OFF	ON
06	ON	OFF	ON	OFF	OFF	22	ON	OFF	ON	OFF	ON
07	OFF	ON	ON	OFF	OFF	23	OFF	ON	ON	OFF	ON
08	ON	ON	ON	OFF	OFF	24	ON	ON	ON	OFF	ON
09	OFF	OFF	OFF	ON	OFF	25	OFF	OFF	OFF	ON	ON
10	ON	OFF	OFF	ON	OFF	26	ON	OFF	OFF	ON	ON
11	OFF	ON	OFF	ON	OFF	27	OFF	ON	OFF	ON	ON
12	ON	ON	OFF	ON	OFF	28	ON	ON	OFF	ON	ON
13	OFF	OFF	ON	ON	OFF	29	OFF	OFF	ON	ON	ON
14	ON	OFF	ON	ON	OFF	30	ON	OFF	ON	ON	ON
15	OFF	ON	ON	ON	OFF	31	OFF	ON	ON	ON	ON
16	ON	ON	ON	ON	OFF	32	ON	ON	ON	ON	ON

## Programmation de la ProSYS

Le chapitre suivant décrit les options logicielles de programmation qui peuvent être ajoutées à la ProSYS, et qui permettent de paramétrer le détecteur WatchOUT DT comme détecteur en mode BUS. Le système peut ainsi recevoir jusqu'à 32 détecteurs BUS (16 en ProSYS 16), chacun d'eux s'inscrivant au détriment d'une zone du système.

Il est vivement recommandé de lire attentivement et de bien comprendre, dans leur intégralité, les instructions détaillées dans les guides d'installation et d'utilisation de la ProSYS avant de programmer le WatchOUT.

### Remarques:

Le WatchOUT est compatible avec les versions 4 xx et supérieures du logiciel ProSYS.

Le WatchOUT peut être programmé via le logiciel U/D (Upload/Download) à partir de la version UD 1.8 et supérieures.

Pour une stabilité optimale du fonctionnement, il est conseillé de NE PAS dépasser un total de 300 mètres (1000 pieds) de longueur de fils électriques pour la connexion du WatchOUT au BUS.

### Ajout / Suppression du WatchOUT DT

Le WatchOUT fait partie d'une nouvelle catégorie d'accessoires ; zones BUS. L'ajout/ la suppression du WatchOUT s'effectue comme pour tout autre accessoire, à une exception près :

**Chaque détecteur de zone BUS Zone doit être attribué à une zone normale.**

Tout détecteur BUS peut être attribué à une zone physique électriquement branchée ou à une zone virtuelle.

**Zone physique :** toute zone sur la carte PCB de la ProSYS (zones 1-8) ou sur une extension de zone électriquement branchée (ZE08, ZE16).

**Zone virtuelle :** toute zone sur une extension de zone BUS définie comme BZ08 ou BZ16.

### Remarques :





Les zones BUS virtuelles ont un coût avantageux. Elles permettent l'extension des zones de votre système sans avoir à ajouter d'extensions de zones physiques.

L'extension de zone BUS ne peut être utilisée que pour les détecteurs de zone BUS.

Pour ajouter une extension de zone BUS, sélectionnez le type BZ08 ou BZ16 lors de l'ajout de l'extension de zone (raccourci clavier [7][1][2]).





### 1. Pour ajouter / supprimer le WatchOUT DT

1. Du menu Installateur, accédez au menu Ajouter/Supprimer : raccourci clavier [7][1][9][5] pour détecteurs de zones BUS.

- A l'aide des touches  /  ou  / , placez le curseur sur le numéro ID de zone BUS auquel vous voulez attribuer (ou pour lequel vous voulez supprimer) un détecteur.

### Remarque :

Assurez-vous que le numéro ID réel du détecteur est bien identique à celui que vous avez sélectionné lors de la programmation.



- Placez le curseur sur le champ de saisie TYPE et à l'aide de la touche  / , sélectionnez l'option ODT15 pour le détecteur WatchOUT DT.
- Appuyez sur la touche  /  pour valider.
- Répétez l'opération pour les autres détecteurs BUS.

## 2. Attribution du WatchOUT DT à une Zone



- Du menu Installateur, accédez aux Zones : option une par une (raccourci clavier **[2][1]**).
- Sélectionnez le numéro de zone que vous souhaitez faire correspondre au détecteur BUS.

### Remarque :

Si vous avez défini une extension de zone BUS, sélectionnez un numéro de zone parmi les zones virtuelles (définie par l'extension de zone BUS).

- Définissez les Partitions, Groupes, Type de zone et Son de zone.
- Dans la catégorie Nature, sélectionnez la **Zone Bus [5]** suivie de la touche  / . L'écran suivant apparaît :

```
Z: 001   COUPLER:
ID: 01   TYPE: OPR15
```

- Sélectionnez le numéro de zone BUS à attribuer à la zone programmée. Le champ "Type" s'actualisera automatiquement lors de la sélection de la zone.
- Appuyez sur la touche  / ,. La catégorie "Rapidité" ne s'applique pas à une zone BUS, l'écran suivant apparaît :



```
Z: 001   RAPIDITE:
P.d.a   ZONE - BUS
```

- Appuyez sur la touche  / , attribuez le nom et appuyez sur  / ,.

## 3. Paramétrage du WatchOUT DT

- Pour accéder à l'option de paramétrage du WatchOUT, appuyez sur **[2][0][3]** à partir du menu principal de l'Installateur. L'écran suivant apparaît :

```
PARAM.   ZONE-BUS:
ZONE#=001 (0:01)
```

- Sélectionnez la zone correspondant à la zone BUS et appuyez sur la touche  / . Vous pouvez maintenant programmer les paramètres du WatchOUT comme suit :

### Zones – Divers : Zone BUS

Touches rapides	Paramètre	Par défaut
-----------------	-----------	------------

<b>[2][0][3][zzz][1]</b>	<b>LEDS</b>	<b>3 LEDS</b>
	Définit le mode de fonctionnement des diodes LED.	

<b>[2][0][3][zzz][1][1]</b>	<b>ETEINT</b>	
	Désactive le fonctionnement des diodes LED.	



## Zones – Divers : Zone BUS

Touches rapides	Paramètre	Par défaut
[2][0][3][zzz] [1][2]	<b>UNIQUEM. ROUGE (Rouge Seulement)</b>	
	Seule la diode rouge fonctionne. Cette option est vivement recommandée pour déjouer toute possibilité d'un éventuel intrus "d'étudier" le comportement du détecteur.	
[2][0][3][zzz] [1][3]	<b>3 LEDS</b>	
	Les 3 diodes LED fonctionnent toutes.	
[2][0][3][zzz] [2]	<b>SENSIBIL. (Sensibilité)</b>	<b>Normal</b>
	Définit le degré de sensibilité IRP du détecteur (HF + IRP)	
[2][0][3][zzz] [2][1]..[4]	<b>Options de degrés de sensibilité</b>	
	1) BAS                    3) NORMAL 2) MOYEN            4) HAUT	
[2][0][3][zzz] [3]	<b>MW RANGE (Portée HF)</b>	<b>POTENTIOMETRE</b>
	Définit l'intervalle du canal hyperfréquence, la valeur maximale étant 23m.	
[2][0][3][zzz] [3][1]..[7]	<b>Options de réglage de la portée HF</b>	
	1) MINIMUM    3) 40%    5) 80%            7) Potentiomètre (la valeur HF est définie 2) 20%            4) 60%    6) MAXIMUM par réglage du potentiomètre sur la carte PCB)	
2][0][3][zzz] [4]	<b>Sensibilité Anti-Masque</b>	<b>Faible sensibilité</b>
	Détermine la sensibilité de détection de masquage par IR actif	
[2][0][3][zzz] [4][1]-[2]	<b>Option de sensibilité de l'Anti-Masque</b>	
	1) Faible sensibilité    2) Sensibilité élevée	
[2][0][3][zzz] [5]	<b>TYPE LENTILLE</b>	<b>GRAND ANGLE</b>
	Définit la lentille en place sur le détecteur.	
[2][0][3][zzz] [5][1]..[2]	<b>Types de lentilles - Options</b>	
	1) GRAND ANGLE    2) RIDEAU / L.P. (Longue portée)	
[2][0][3][zzz] [6]	<b>ANTI-MASQUE</b>	<b>ACTIVE</b>
	Définit le fonctionnement de la détection par anti-masque.	
[2][0][3][zzz] [6][1]..[2]	<b>Options Anti-Masque</b>	
	1) DESACTIVE    2) ACTIVE (par défaut)	
[2][0][3][zzz] [7]	<b>ARME/DESARME</b>	<b>NON</b>
	Définit le fonctionnement des diodes LED de détection anti-masque lorsque le détecteur est armé.	
[2][0][3][zzz] [7][1]	<b>NON</b>	
	.La détection de l'AM par IR actif et la proximité sont opérationnels LEDs suivant la programmation des paramètres des LEDs	

## Zones – Divers : Zone BUS

Touches rapides	Paramètre	Par défaut
[2][0][3][zzz] [7][2]	<b>OUI</b>	
	.a détection de l'AM par IR actif et la proximité sont désactivés LEDs sont désactivées	
[2][0][3][zzz] [8]	<b>AM Prox.</b>	<b>DESACTIVE</b>
	Définit le fonctionnement de la détection par Anti-Masque de Proximité.	
[2][0][3][zzz] [8][1]..[2]	<b>Options AM Prox.</b>	
	1) DESACTIVE (par défaut) 2) ACTIVE <b>NOTE:</b> Désactiver l'AM de proximité lors de fortes pluies (si le WatchOUT 315DT n'est pas à l'abri de la pluie) pour éviter les alertes d'AM de proximité.	









## Paramètres Système

### Système : Contrôle du système

Touches rapides	Paramètre	Par défaut
[1][2][36]	<b>IR AM=SABOTAGE</b>	<b>N</b>
	Sert à déterminer le fonctionnement de la détection Anti-Masque. <b>[O] Oui :</b> Toute violation de l'anti-masque déclenchera une alarme d'autoprotection. <b>[N] Non :</b> Toute violation de l'anti-masque sera considérée comme un événement de défaut.	
[1][2][37]	<b>AM PROX=SABOT.</b>	<b>N</b>
	Sert à déterminer le fonctionnement de la détection Anti-Masque de Proximité. <b>[O] Oui :</b> Toute violation de l'anti-masque de proximité déclenchera une alarme d'autoprotection. <b>[N] Non :</b> Toute violation de l'anti-masque de proximité sera considérée comme un événement de défaut.	

## Diagnostic

La ProSYS vous permet de tester les paramètres traduisant le fonctionnement du détecteur.

1. Du menu principal de l'utilisateur, appuyez sur la touche  [4] pour accéder au menu de Maintenance.
2. Tapez le code Installateur (ou Sous-installateur) et appuyez sur la touche  / .
3. Appuyez sur les touches **[9] [1]** pour accéder au menu du Diagnostic des zones BUS.
4. Tapez le numéro de la zone que vous voulez tester et ensuite appuyez sur  / . Le système accomplira alors le diagnostic et une liste des paramètres de test apparaîtra, comme indiquée dans le tableau ci-dessous.
5. A l'aide des touches  /  et  / , visualisez les résultats du diagnostic.

---

**Menu Utilisateur: 4) Maintenance → 9) Diagnostique → 1) DIAGNOST. ZONE**

---

**Raccourcis      Paramètre**  
**clavier**

---

<b>[4][9][1][zzz]</b>	<b>ALIMENTATION</b> : affiche l'alimentation électrique du détecteur.
	<b>IRP 1 NIVEAU</b> : affiche le niveau CC du canal IRP 1. Intervalle : 0.1v - 4v.
	<b>IRP 1 BRUIT</b> : affiche le niveau CA du canal IRP 1. Intervalle : 0VCA (pas de bruit) - 4VCA.
	<b>IRP 2 NIVEAU</b> : affiche le niveau CC du canal IRP 2. Intervalle: 0.1v - 4v.
	<b>IRP 2 BRUIT</b> : affiche le niveau CA du canal IRP 2. Intervalle: 0VCA (pas de bruit) - 4VCA.
	<b>MW 1 NIVEAU</b> : affiche le niveau CC du canal HF 1. Intervalle : 0.1v - 4v.
	<b>MW 1 BRUIT</b> : affiche le niveau CA du canal HF 1. Intervalle : 0VCA (pas de bruit) - 4VCA).
	<b>MW 2 NIVEAU</b> : affiche le niveau CC du canal HF 2. Intervalle : 0.1v - 4v.
	<b>MW 2 BRUIT</b> : affiche le niveau CA du canal HF 2. Intervalle : 0VCA (pas de bruit) - 4VCA).



## Tabela De Conteúdo

<b>Instalação no modo Relé</b> .....	<b>70</b>
<b>Introdução</b> .....	<b>70</b>
<b>Montagem</b> .....	<b>70</b>
Considerações de Montagem.....	70
Instalação com Montagem de Parede.....	71
Montagem em Superfície:.....	71
Montagem com Ângulo de 45 (Montagem do lado esquerdo).....	71
Mudando a posição do tamper de parede.....	72
<b>Terminais de Fiação</b> .....	<b>72</b>
<b>Ajustes dos Dipswitches</b> .....	<b>73</b>
<b>Ajuste de Microondas</b> .....	<b>73</b>
Teste de Caminhada.....	73
<b>LED's demonstradores</b> .....	<b>74</b>
<b>Jumper de ajuste entre o Modo Relé e o Modo Bus</b> .....	<b>74</b>
<b>Instalação com Suporte Padrão</b> .....	<b>74</b>
Montagem de parede.....	74
Montando o suporte com conduíte.....	75
<b>Trocando as lentes</b> .....	<b>77</b>
Tipos de Lentes.....	78
<b>Especificações Técnicas</b> .....	<b>79</b>
<b>Informações de pedidos</b> .....	<b>79</b>
<b>Instalação no modo BUS</b> .....	<b>80</b>
<b>Introdução</b> .....	<b>80</b>
<b>Terminais de Fiação</b> .....	<b>80</b>
<i>Tamper de tampa e traseiro</i> .....	80
<i>Apenas tamper de tampa</i> .....	80
<i>Ligação de Tamper de tampa em uma entrada de zona</i> .....	80
<b>Ajustes dos Dipswitch's</b> .....	<b>80</b>
<b>Programando a ProSYS</b> .....	<b>81</b>
Adicionando / Apagando o WatchOUT DT.....	81
Configurando os parâmetros do WatchOUT DT.....	82
<b>Parâmetros do Sistema</b> .....	<b>83</b>

# Instalação no modo Relé



## Introdução

O WatchOUT DT315, Detector de dupla tecnologia da RISCO Group é o único detector com um processamento baseado em dois canais de Infravermelho Passivo (IVP) e dois canais de Microondas (MO). Ele pode trabalhar como um detector convencional, conectado em qualquer central de alarme através de relé, ou como um acessório de Bus, quando conectado no painel de controle ProSYS da RISCO Group através do BUS 485, possibilitando a capacidade de Controle e Diagnósticos remotos.

As Instruções aqui descritas referem-se ao WatchOUT 315DT no modo Relé & no modo BUS. Para informações detalhadas a respeito do modo BUS.

## Montagem

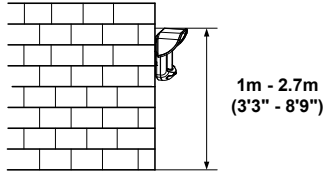
### Considerações de Montagem

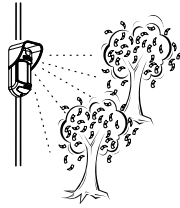
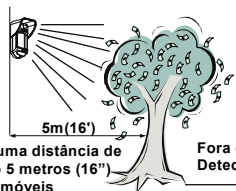
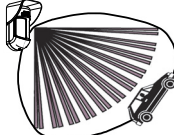
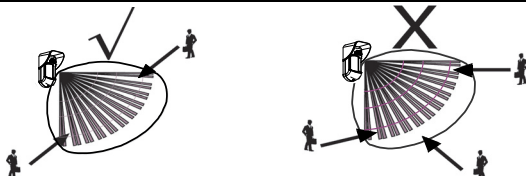
 <p>1m - 2.7m (3'3" - 8'9")</p> <p>Opções de altura: 1m – 2.7m (3'3"-8'9") Altura Típica: 2.2m (7'2") Lente instalada de Fábrica: Ângulo aberto 15m (50') 90° (RL300)</p> 	 <p>Procure evitar direcionar o detector para objetos que possam se mover (Galhos de árvores que balançam com o vento, arbustos e etc.).</p>
<p><b>Nota:</b></p> <ol style="list-style-type: none"><li>1. Para instalações com altura abaixo de 1.7m (5'6") onde a imunidade contra animais é necessária, use a lente RL300F (incluída) (paredes baixas ou instalações em cercas).</li><li>2. A imunidade contra animais do detector (altura do animal, sem limitação de peso), é de até 70 cm (2'4"), quando o detector está instalado a 2.2m (7'2"). Caso a instalação tenha altura inferior, a imunidade contra animais diminui, para cada 10 cm (4") na altura de instalação, a imunidade contra animais diminui 10 cm (4").</li></ol>	 <p>Mantenha uma distância de no mínimo 5 metros (16") de objetos móveis</p> <p>Fora da Área de Detecção</p> <p>Assegure-se que nenhum objeto obstrua o campo de detecção para ambas as tecnologias. Preste atenção em plantas e arbustos que podem crescer plantas com grande movimento e etc.</p>
<p>Para instalações onde existe movimento de carros ou objetos além da área protegida, é recomendado que se faça o ajuste de sensibilidade de microondas para o necessário e/ou incline o detector para baixo.</p> <p><b>Nota:</b> Inclinar o detector para baixo reduz a imunidade contra animais.</p>	
<p>Para uma detecção melhorada, escolha um local de preferência onde o detector intercepte o intruso com movimentos transversais, de trajetória de 45°.</p>	
<p><b>NOTA:</b> Desabilite o Antimáscara por proximidade durante chuvas fortes (caso o WatchOUT RK315DT não esteja instalado em área coberta) para evitar alertas de Antimáscara por proximidade.</p>	

## Instalação com Montagem de Parede

### Nota

A numeração dos furos pré-marcados de instalação está marcada na parte de trás do detector.

1. Abra a tampa dianteira do WatchOUT (desparafuse C1, Figura 1).
2. Libere a base interna (desparafuse I1, Figura 2).
3. Escolha o tipo de montagem de instalação como segue abaixo:

### Montagem em Superfície:

Abra os furos pré-marcados na base externa (Figura 3).

- B1 - B4: Furo pré-marcado de montagem de parede
- T1: Furo pré-marcado de tamper de parede
- W2 / W3: Furo pré-marcado de entrada de fiação

### Montagem com Ângulo de 45 (Montagem do lado esquerdo)

- a. Abra o furo pré-marcado na base externa (Figura 3)
  - L1, L2: Furo pré-marcado de montagem do lado esquerdo.
  - T3: Furo pré-marcado de tamper do lado esquerdo
  - W5 / W6: Furo pré-marcado de entrada de fiação
- b. Remova a mola do tamper
- c. Recoloque a chave de tamper (Item 1) com o suporte de superfície do tamper (Item 2).

Item 1



Item 2



- d. Insira a alavanca do tamper B no T5 e T3 e aperte o parafuso A (Figura 3)
4. Insira os fios externos através da base externa W2, W3 (Montagem de superfície) ou W5, W6 (Montagem do lado esquerdo) (Figura 3).
  5. Fixe a base externa na parede.
  6. Insira a fiação externa e a fiação do tamper através da base interna (Figura 4).
  7. Fixe a base interna na base externa (Trave I1, Figura 2).
  8. Feche a tampa dianteira (Aperte C1, Figura 1) após ligar toda a fiação e ajustar os Dipswitches.
  9. Faça o teste de caminhada no detector

Figura 1



Figura 2



Figura 3

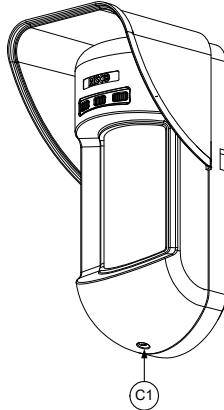

Figura 4

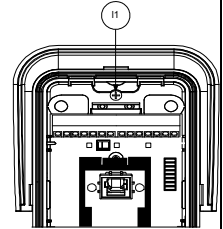

**Nota:**

Para instalações de 45° do lado direito use as unidades equivalente da base externa:

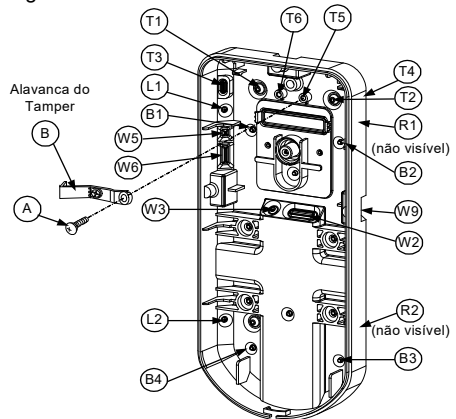
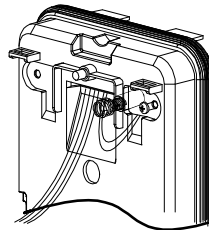
Descrição dos furos pré-marcados	Esquerda	Direita
Furos pré-marcados de montagem	L1, L2	R1, R2
Furos pré-marcados de mola do Tamper	T1, T3	T2, T4
Encaixe de parafuso do Tamper	T5	T6
Furos pré-marcados de fiação	W5, W6	W7, W8

**Mudando a posição do tamper de parede**

O Tamper de parede vem de fábrica preso do lado direito da base interna (olhando pelo fundo). Caso você deseje modifica-lo para o lado esquerdo (olhando pelo fundo), faça como segue abaixo:

(Figura 5):

1. Remova o parafuso do tamper 1 para liberar o tamper da posição 7.
2. Fixe a mola do tamper 2 sobre a chave do tamper 4.
3. Fixe o suporte plástico do tamper 3 sobre ambos os pontos 2 e 4.
4. Aperte o parafuso do tamper 1 no 3 sobre a posição 6.

Figura 5

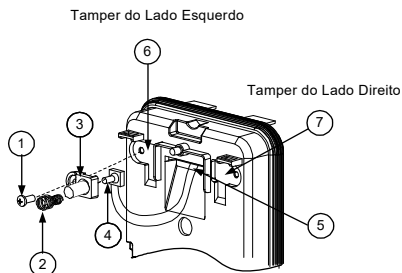
**Notas:**

1. Assegure-se de ouvir o "Cliques" quando prender a mola do tamper na parede.
2. Para instalações de poste, O tamper deve ser movido para o fundo direito da base interna do detector.

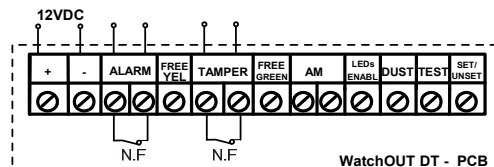
**Terminais de Fiação**

<b>+,-</b>	12 VDC
<b>ALARM</b>	Relé Normalmente Fechado (NF), 24VDC , 0.1A
<b>FREE YEL</b>	Esse terminal é um pino livre, pode ser usado para conectar fios e resistores de final de linha (EOL)
<b>TAMPER</b>	Relé N.F , 24VDC , 0.1A
<b>FREE GREEN</b>	Esse terminal é um pino livre, pode ser usado para conectar fios e resistores de final de linha (EOL)
<b>AM</b>	Saída de Relé NF para indicação de Mascaramento. (24VDC, 0.1A) indica que um alarme de anti-máscara ou um problema no detector (Não inclui alerta de lente suja) O Anti-mascaramento de proximidade possibilita receber alertas antes do detector ser mascarado ou sofrer danos, usando os dois canais de microondas.
<b>LED ENABLE</b>	Usado para controlar remotamente os Led's quando o <b>DIP1</b> está ajustado na posição ON (ligado). Habilitar: Ligar +12V OU sem ligação no Terminal Desabilitar: Conectar 0V no terminal

**Nota:**

Quando o DIP8 é definido como habilitado este relé também se abre momentaneamente, quando ocorrem tentativas de mascaramento. Nesse caso, o relé permanecerá aberto pelo menos 20 segundos e será fechado após a detecção de movimento.



<b>DUST</b>	N/A												
<b>TEST</b>	Usado para testar a saída de alarme remotamente, testando o detector ao aplicar 0V nesse terminal. Sucesso: O relé de alarme é momentaneamente aberto. Falha: O relé de Anti-Máscara (AM) é aberto												
<b>SET/ UNSET</b>	Essa entrada possibilita o controle do sistema Anti-máscara e da operação dos Led's de acordo com o estado, Set = (ativado) / Unset (Desativado). Enquanto o sistema estiver desarmado essa característica previne que o intruso tenha conhecimento do estado do detector e desabilite o Anti-máscara.												
	<table border="1"> <thead> <tr> <th>Estado do Sistema</th> <th>Estado da entrada</th> <th>Relé AM</th> <th>LED's</th> </tr> </thead> <tbody> <tr> <td>Set (Ativado)</td> <td>0V</td> <td>Desabilitado</td> <td>Desligado</td> </tr> <tr> <td>Unset (Desativado)</td> <td>12V ou sem conexão</td> <td>Habilitado*</td> <td>Habilitado**</td> </tr> </tbody> </table> <p>* DIP7 na posição ON (Anti-máscara habilitado) ** DIP1 na posição ON (LEDs Habilitados) e o terminal de entrada LEDs ENABLE habilitado (+12V OU sem conexão)</p>	Estado do Sistema	Estado da entrada	Relé AM	LED's	Set (Ativado)	0V	Desabilitado	Desligado	Unset (Desativado)	12V ou sem conexão	Habilitado*	Habilitado**
Estado do Sistema	Estado da entrada	Relé AM	LED's										
Set (Ativado)	0V	Desabilitado	Desligado										
Unset (Desativado)	12V ou sem conexão	Habilitado*	Habilitado**										

### Ajustes dos Dipswitches

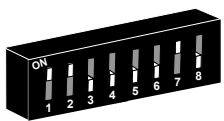

Padrão de fábrica

**DIP 1:** Operação dos LED's  
On: LED's Habilitados  
Off: LED's Desabilitados

**DIP 2-3:** Sensibilidade de Detecção

Sensibilidade	DIP2	DIP3
Baixa	Off	Off
Média	Off	On
Normal (Valor de Fábrica)	On	Off
Máxima*	On	On

\* Na sensibilidade máxima a tecnologia de reconhecimento de oscilação fica desabilitada para alcançar o máximo de sensibilidade

- DIP 4:** Sensibilidade do Anti-máscara  
On: Alta  
Off: Baixa
- DIP 5:** Ótica de detecção  
On: Barreira / Longo alcance  
Off: Ângulo aberto
- DIP 6:** LED Vermelho / 3 LED  
On: Apenas LED vermelho  
Off: 3 LED's
- DIP 7:** Operação do Anti-máscara  
On: Habilitado  
Off: Desabilitado
- DIP 8:** AM por proximidade  
On: Habilitado  
Off: Desabilitado

### Ajuste de Microondas

Ajuste a cobertura da área de detecção do Microondas usando o Trimmer no PCB.



### Teste de Caminhada

Dois minutos depois de ligar a energia elétrica, faça o teste de caminhada, caminhando na área protegida e verificando o correto funcionamento.

Para instalações com superfícies irregulares deslize o PCB dentro da base interna para o ajuste apropriado de acordo com a altura desejada (1.0m, 1.5m, 2.2m, 2.7m) de acordo com a escala impressa no canto esquerdo de baixo do PCB, ou use o acessório de suporte padrão.

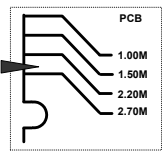

Para reduzir a escala de detecção, deslize o PCB para CIMA ou incline o suporte padrão para BAIXO.

## LED's demonstradores

LED	Estado	Descrição
Amarelo	Acesa	Indica detecção por Infravermelho Passivo
	Piscando	Indica detecção do sistema Anti-máscara (AM)
Verde	Acesa	Indica detecção por Microondas
	Piscando	Indica detecção de Anti-Mascaramento por Proximidade
Vermelho	Acesa	Indica ALARME
	Piscando	Indica mal funcionamento da comunicação com a ProSYS (apenas no modo BUS)
Todos os LED's	Piscando (Um depois do outro)	Unidade em iniciação. (logo após a eletricidade ser ligada)

### Notas:

1. O Dipswitch 1 precisa estar na posição ON para que a indicação dos LED's esteja Habilitada
2. Apenas um Led é ativado por vez. Por exemplo, no caso de ambos os canais de Infravermelho Passivo e de Microondas detectarem, um ou outro irá acender, ou o LED Amarelo ou o LED verde (o primeiro a detectar), seguido pelo LED de alarme.
3. Para evitar a análise das tecnologias de detecção, tais como Alarme, Anti-Mascaramento e Anti-Mascaramento por Proximidade, coloque a chave 6 (no SW1) na posição ON. Somente o LED vermelho será ativado.

## Jumper de ajuste entre o Modo Relé e o Modo

### Bus

O Jumper J-BUS (localizado no PCB entre os Led's vermelho e verde) é usado para definir o modo de operação do detector, como explicado abaixo:

Modo Relé



Modo BUS



## Instalação com Suporte Padrão

A embalagem do Detector Externo contém um suporte rotativo para possibilitar flexibilidade nas instalações. Por favor siga as instruções para a montagem do Suporte Padrão como segue abaixo:

1. Abra a tampa frontal do WatchOUT (Desparafuse C1, Figura1).
2. Libere a base interna (Desparafuse I1, Figure2).
3. Abra os furos pré-marcados na base externa (Figura 6, Detalhe B)
  - W1: Furos pré-marcados de fiação
  - S1,S2: Furos pré-marcados para fixar a base externa no Suporte Padrão
  - S3: Parafuso de travamento da base externa
4. No acessório do Suporte Padrão remova os furos pré-marcados de fiação S2, S7 ou S9 (Figura 6, Detalhe A).
5. Remova o tamper de parede da base interna (Veja o item: "Mudando a posição do tamper de parede") e conecte-o no S5 (Figura 6, Detalhe A) do Suporte Padrão.

### Nota:

Verifique se a marca **UP** está do lado de cima do suporte padrão.

6. Selecione o tipo de montagem de instalação como segue abaixo:

### Montagem de parede

- a. Insira o cabeamento externo através dos furos pré-marcados S2, S7 ou S9 e puxe-os (incluindo a fiação de tamper) Através da passagem de fiação do suporte padrão (Figura 6, Detalhe B).
- b. Fixe o suporte na parede através dos furos S1, S3, S6 e S8.

## Montando o suporte com conduíte (usando o Adaptador Metálico do Suporte de Conduíte - AMSC, Figura 6, Detalhe A)



Figura 6

### Nota:

O AMSC é necessário quando existe um Conduíte de passagem de fiação externo na parede. O AMSC é vendido separadamente – O código para pedido é RA300SC0000A.

- Escolha a posição do AMSC de acordo com o diâmetro: 16mm (0.63 polegadas) ou 21mm (0.83 polegadas).
- Insira o tubo de conduíte no AMSC.
- Fixe o AMSC na parede através dos pontos (M1, M4).
- Insira os cabos externos e os fios do tampão na passagem de fiação do Conduíte (Figura 6, Detalhe A).
- Fixe o Suporte na parede através dos furos S1, S3, S6 e S8.

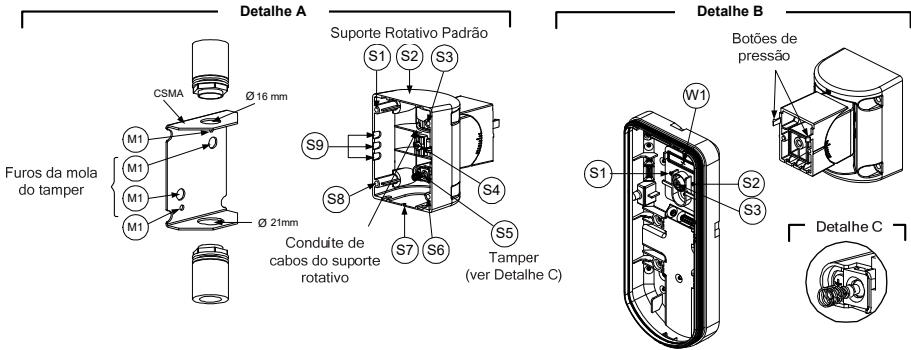
### Nota:

A mola do Tampão S5 (Figura 7) deve fazer contato com a parede através dos furos M2 ou M3 do AMSC. Assegure-se de ouvir o “Cliques” quando conecta-lo na parede.

- Insira os fios do tampão e os cabos externos através do furo pré-marcado W1 do Suporte Padrão na base externa (Figura 6, Detalhe B).
- Conecte a base externa no suporte usando as garras apropriadas (Figura 8).



Figura 7

**Nota:**

Não aperte ou afrouxe o parafuso interno de regulação do suporte, ele é usado apenas para conectar as partes internas do suporte.

9. Fixe a base externa no suporte com os dois parafusos fixados nos furos pré-marcados S1 e S2 (Figura 7).
10. Insira o parafuso incluso de travamento do ângulo da base externa através do furo pré-marcado de parafuso de travamento de ângulo S3 na base externa do suporte padrão (Figura 7).
11. Incline e gire o Suporte Padrão para posição desejada. Uma vez que o suporte padrão esteja na posição desejada, aperte o parafuso de travamento de ângulo.
12. Alinhe a base externa na base interna. Inserindo todos os fios através da base interna.
13. Fixe a base interna na base externa (Trave I1, Figura 2).
14. Para reajustar o Suporte Padrão quando o PCB já está instalado (Figura 8):
15. Dobre para baixo a espuma preta localizada abaixo do LED vermelho no PCB (Apenas a distância suficiente para acessar o parafuso de travamento de ângulo).
  - a. Use uma chave de fenda tipo Philips para liberar o parafuso de travamento de ângulo (veja a Figura 8).
  - b. Incline/Gire o Suporte Padrão para a posição desejada.
  - c. Aperte o parafuso de travamento de ângulo.

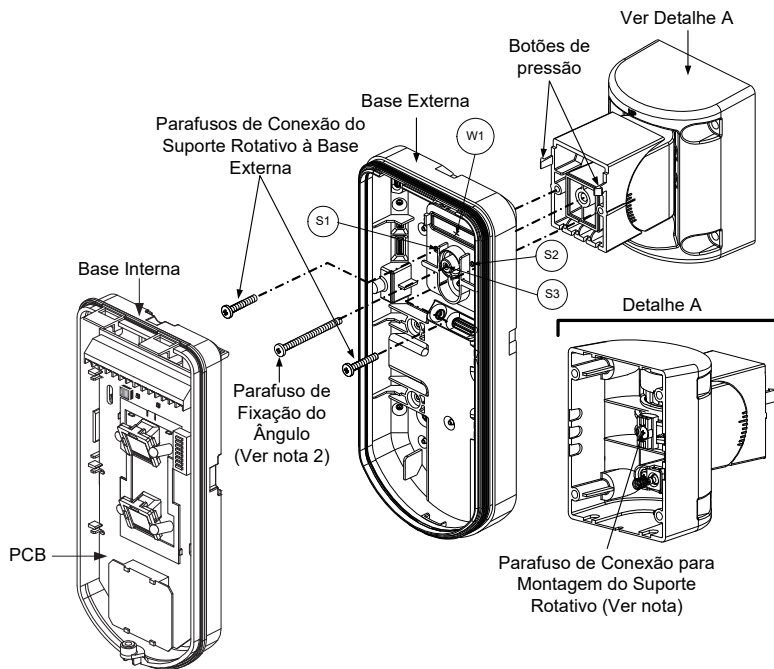
**Nota:**

Quando as duas marcas das partes móveis do suporte estiverem alinhadas (Figura 7), o suporte padrão estará na posição de 0° vertical /horizontal. Cada clique da posição representa uma mudança de posição Vertical / Horizontal de 5°.

16. Feche a tampa frontal (Trave C1, Figura 1) e faça o teste de caminhada no detector.

**Nota:**

O parafuso tem que passar através da base externa e travar o suporte.



Figura 8

## Trocando as lentes

1. Destrave os seis parafusos que seguram a lente e o protetor de elemento óptico na parte de trás da tampa frontal.
2. Para liberar o protetor de elemento óptico, gentilmente empurre a lente do lado externo da tampa para o lado de dentro.
3. Desconecte a lente do protetor de elemento óptico empurrando gentilmente os cliques que seguram a lente no protetor.
4. Recoloque a lente. Posicione os 4 cliques da lente alinhados ao protetor de elemento óptico.
5. Insira o protetor do elemento óptico na parte de trás da tampa frontal. Preste atenção no posicionamento do protetor na borracha de vedação.
6. Fixe os 6 parafusos de travamento nos seus devidos lugares.

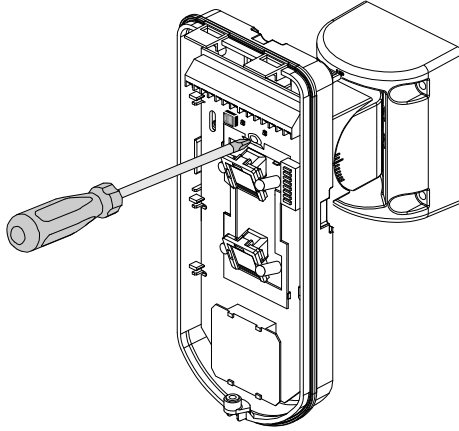
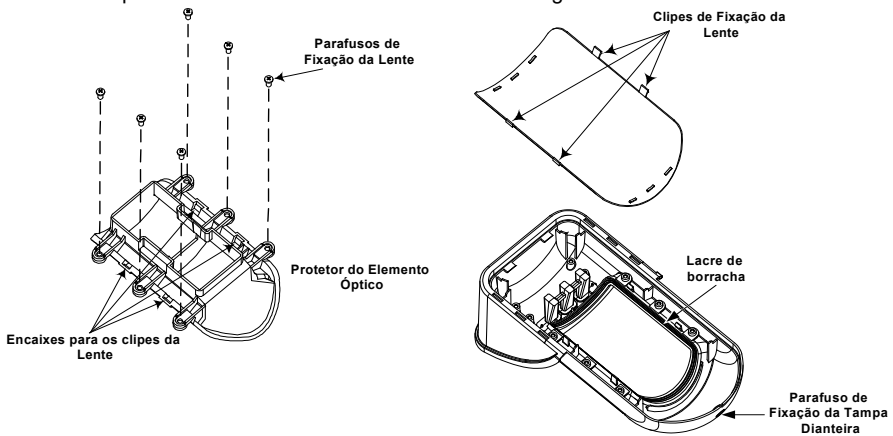

## Tipos de Lentes

### Lente de Ângulo Aberto (RL300) / Instalação Baixa – Lente Pet(RL300F) :

#### Visão Superior

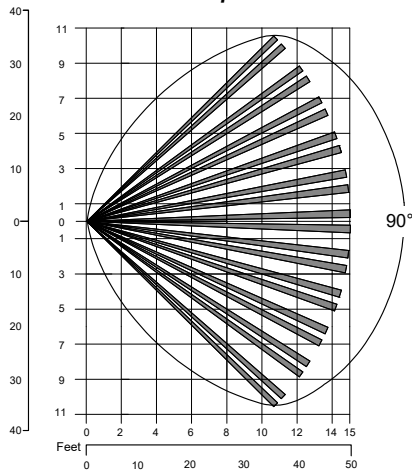

### Lente de Ângulo Aberto (RL300):

#### Visão Lateral

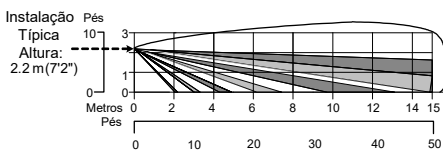

### Instalação Baixa – Lente Pet (RL300F) :

#### Visão Lateral

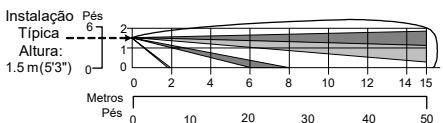

#### Nota:

A imunidade contra animais do detector (Altura do animal, não há limitação de peso), é de 70 cm (2'4"), quando o detector é instalado em 2.2m (7'2") de altura. Caso a instalação seja mais baixa que a altura mencionada acima, a imunidade contra animais diminui proporcionalmente; para cada 10 cm (4") a menos na altura de instalação representa 10 cm (4") de diminuição na imunidade contra animais.

### Lente de longo alcance (RL300LR):

#### Visão superior

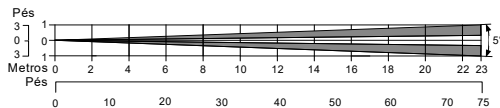

### Lente de Barreira (RL300B):

#### Visão Superior

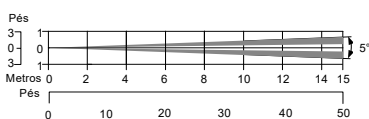

### Lente de longo alcance (RL300LR):

#### Visão lateral

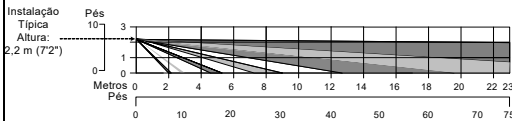

### Lente de Barreira (RL300B):

#### Visão lateral

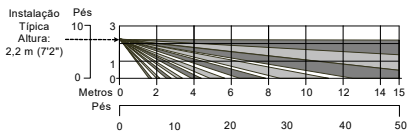

## Especificações Técnicas

Elétricas	
Consumo de Corrente	30mA @ 12 VDC (Stand by) 42mA @ 12 VDC (MAX com todos os LED's ligados)
Necessidade de tensão	9 -16 VDC
Contatos de Alarme	24 VDC, 0.1A
Contatos de AM (Anti-máscara)	24 VDC, 0.1A
Saída de proteção contra sujeira na lente	Coletor aberto 70mA max
Potenza trasmissa	10.587GHZ: 10dbm Typ.
Frequenza	10.587GHZ
Dimensões	
Tamanho: AxCxL	220 x 115 x 123mm (8.7 x 4.5 x 4.85 polegadas.)
Peso	0.632 Kg (1.4lb)
Ambiental	
Imunidade RF	De acordo com EN50130-4
Temperatura de Operação/Estocagem	-30°C to 60°C (-22°F to 140°F)

\* A tecnologia IVP é limitada em ásperas condições ambientais

## Informações de pedidos

### Unidades padrão

Modelo	Descrição
WatchOUT 315DT	WatchOUT DT + Suporte
<b>Nota:</b>	
Cada embalagem do WatchOUT contém um Detector, 1 Suporte Padrão, 1 lente instalada e mais 3 lentes para troca (Código gravado na lente) 1.7m Imune para pequenos animais com instalação baixa (RL300F) longo-alcance (RL300R) Lente de Barreira (RL300B).	

### Kits de acessórios

Modelo	Descrição	Peso
RA300B	WatchOUT Kit de Suporte de Barreira	0.1 Kg (0.23 lb)
RA300P	WatchOUT Kit de adaptador de Poste	0.25 Kg (0.55 lb)
RA300C	WatchOUT Kit de adaptador de Conduíte	0.6 Kg (1.27 lb)
RA300HS	WatchOUT Demonstrador	- -
RA300SC	WatchOUT Adaptador Metálico de Suporte de Conduíte	1Kg (2.2 lb)

### Opção de Câmera

Modelo	Descrição
WatchOUT VC1	Tampa adaptadora de Câmera para o WatchOUT
WatchOUT VC017	Câmera com lente de longo alcance para o WatchOUT
WatchOUT VC053	Câmera com lente de ângulo aberto para o WatchOUT
WatchOUT VCPS	Fonte de alimentação 220V para câmara do WatchOUT
WatchOUT VCPS	Fonte de alimentação 120 V para a câmara do WatchOUT

## Instalação no modo BUS

### Introdução

As informações nessa parte do manual se referem à instalação do WatchOUT 315DT apenas no modo BUS. Até 32 detectores podem ser instalados no barramento (BUS) RS485 da ProSYS, economizando tempo e fiação e possibilitando controle e diagnósticos remotos.

### Terminais de Fiação

<b>+, -</b>	Usado para conectar a alimentação 12VDC. Conecte o terminal (+) no AUX RED (vermelho) e o terminal (-) no COM BLK (preto) dos terminais da ProSYS
<b>YELLOW</b>	Usado para a comunicação de dados com a ProSYS. Conecte no terminal <b>BUS YEL</b> (amarelo) da ProSYS.
<b>GREEN</b>	Usado para a comunicação de dados com a ProSYS. Conecte no terminal <b>BUS GRN</b> (verde) da ProSYS.
<b>TAMPER</b>	Usado para ligar a fiação da detecção de Tamper, veja abaixo
<b>LED ENABLE</b>	Usado para ligar a fiação da detecção de Tamper, veja abaixo

#### Nota:

Todos os terminais que não são mencionados na tabela acima, não são usados no modo BUS.

#### Tamper de tampa e traseiro

#### Apenas tamper de tampa

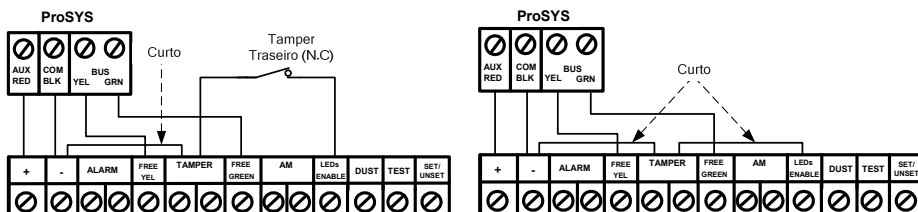

#### Ligação de Tamper de tampa em uma entrada de zona

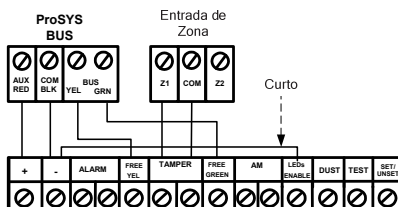

### Ajustes dos Dipswitch's

Numero do Dipswitch	Descrição
1 - 5	Usado para ajustar o número de ID (identificação) do detector. Ajuste o número do ID da mesma forma que é feito o ajuste de qualquer outro acessório da ProSYS (Consulte o Manual de Instalação da ProSYS)
6 - 8	Não Usado



## WatchOUT ID: Dipswitches 1 - 5

ID	1	2	3	4	5
01	OFF	OFF	OFF	OFF	OFF
02	ON	OFF	OFF	OFF	OFF
03	OFF	ON	OFF	OFF	OFF
04	ON	ON	OFF	OFF	OFF
05	OFF	OFF	ON	OFF	OFF
06	ON	OFF	ON	OFF	OFF
07	OFF	ON	ON	OFF	OFF
08	ON	ON	ON	OFF	OFF
09	OFF	OFF	OFF	ON	OFF
10	ON	OFF	OFF	ON	OFF
11	OFF	ON	OFF	ON	OFF
12	ON	ON	OFF	ON	OFF
13	OFF	OFF	ON	ON	OFF
14	ON	OFF	ON	ON	OFF
15	OFF	ON	ON	ON	OFF
16	ON	ON	ON	ON	OFF

ID	1	2	3	4	5
17	OFF	OFF	OFF	OFF	ON
18	ON	OFF	OFF	OFF	ON
19	OFF	ON	OFF	OFF	ON
20	ON	ON	OFF	OFF	ON
21	OFF	OFF	ON	OFF	ON
22	ON	OFF	ON	OFF	ON
23	OFF	ON	ON	OFF	ON
24	ON	ON	ON	OFF	ON
25	OFF	OFF	OFF	ON	ON
26	ON	OFF	OFF	ON	ON
27	OFF	ON	OFF	ON	ON
28	ON	ON	OFF	ON	ON
29	OFF	OFF	ON	ON	ON
30	ON	OFF	ON	ON	ON
31	OFF	ON	ON	ON	ON
32	ON	ON	ON	ON	ON

## Programando a ProSYS

A seção a seguir descreve a programação adicional das opções de software, adicionado ao software da ProSYS, que descreve o ajuste do WatchOUT DT como um detector de BUS . Até 32 detectores podem ser adicionados ao sistema (16 na ProSYS 16) e cada um ocupará virtualmente uma das zonas do sistema.

É altamente recomendável a leitura e o total entendimento do manual do instalador e do usuário da ProSYS, antes de programar o WatchOUT

### Notas:

O WatchOUT é compatível com o Software de ProSYS na versão 4.xx ou posterior.

O WatchOUT pode ser programado através do Software de U/D através de um software com versão superior ou igual a 1.8.

Para o máximo de estabilidade na instalação, é melhor NÃO exceder o limite de 300 metros (1000 Pés) para a fiação, quando o WatchOUT é ligado no modo BUS.

### Adicionando / Apagando o WatchOUT DT

O WatchOUT é um dos novos acessórios da nova categoria, zona de BUS. Consequentemente, Adicionar / Apagar o WatchOUT é idêntico a qualquer outro acessório com as seguintes exceções:

**Cada detector de BUS deve ser alocado a uma zona comum.**

Qualquer detector de BUS pode ser alocado a uma zona de fio, ou a um expansor virtual de zona.

**Zona Física:** Qualquer zona no PCB do ProSYS (zonas 1-8) ou em um expansor com fio (ZE08, ZE16).

**Zona Virtual:** Qualquer zona em um expansor virtual de zona, definido como BZ08 ou BZ16.





### Notas:

Zonas Virtuais são mais econômicas. Elas possibilitam expandir o sistema em zonas sem adicionar nenhum expansor de zona físico (não há hardware).

O expansor virtual de zona de Bus pode ser usado apenas para os detectores de zona de BUS.





Para adicionar um Expansor de zona de BUS selecione o tipo de expansor BZ08 ou BZ16 quando adicionar um expansor de zona (Tecla Rápida [7][1][2]).

### 1. Para adicionar / Deletar o WatchOUT DT

- Através do menu principal do Instalador entre no sub-menu ADIC/APAG MOD: tecla rápida [7][1][9][5] para os expansores de zonas de BUS.
- Use as teclas  /  ou  / . para posicionar o cursor no número de ID do expansor de zona de BUS, para o qual você deseja habilitar (ou apagar) um detector.

**Nota:**

Assegure-se que o detector está com os Dipswitch's fisicamente ajustados para um número de ID idêntico ao qual você selecionou durante a programação.



3. Posicione o cursor no campo TIPO e usando a tecla  /  selecione ODT15 para o detector WatchOUT DT.
4. Aperte  /  para confirmar.
5. Repita o processo para todos os detectores de Bus que serão adicionados ao sistema.

**2. Alocando o WatchOUT DT a uma zona**



1. Através do menu principal do Instalador entre em Zonas: Opções Uma a Uma (Tecla Rápida [2][1])
2. Selecione o número de zonas que você deseja alocar o detector de BUS.

**Nota:**





Se você definir um expansor como Zona de BUS escolha um número de zona do expansor virtual de zona (definido como expansor de zona de BUS).

1. Defina as partições, Grupos, Tipo de zona e som da zona.
2. Na Campo Terminação, escolha o item [5] ZONA BUS seguido pela tecla  / . Aparecerá a tela abaixo:

Z:001 LINK PARA: ID=01 TIPO=ODT15
--------------------------------------

3. Selecione o número da Zona de BUS que será alocada na programação de zona. O Campo TIPO será atualizado automaticamente quando a zona for selecionada.
4. Aperte  / . A sensibilidade (Tempo de Resposta da zona) não é aplicável para as zonas de BUS como aparece na tela abaixo: s:



Z:001 SENSIBILID: N/A-ZONA BUS
-----------------------------------

5. Aperte  / , Escreva o nome da zona e aperte  / .

**3. Configurando os parâmetros do WatchOUT DT**

1. Para acessar as opções de ajustes do WatchOUT aperte [2][0][3] do menu principal do instalador. A seguinte tela aparecerá:

PRMS ZONA BUS: ZONA#=001 (0:01)
------------------------------------

2. Escolha a zona de BUS que será ajustada e aperte a tecla  / . Agora você pode programar os parâmetros do WatchOUT , como segue abaixo:

**Zonas Diversos: Zona BUS**

Teclas Rápidas	Parâmetros	Padrão de Fábrica
[2][0][3][zzz] [1]	<b>LEDS</b> Define o modo de operação dos LED's.	<b>3 LEDS</b>
[2][0][3][zzz] [1][1]	<b>Desabilitados</b> Desabilita a operação dos LED's.	
[2][0][3][zzz] [1][2]	<b>Apenas Vermelho</b> Apenas o led vermelho irá operar. Essa opção é altamente recomendável para evitar a possibilidade que um intruso possa "aprender" o comportamento do detector.	
[2][0][3][zzz] [1][3]	<b>3 LEDS</b> Todos os 3 leds estarão funcionando.	
[2][0][3][zzz] [2]	<b>Sensibilidade do IVP</b> Define a sensibilidade do detector Infravermelho Passivo.	<b>Normal</b>

[2][0][3][zzz] [2][1]..[4]	<b>Opções de Sensibilidade</b> 1) Baixa                      3) Normal 2) Média                      4) Alta
[2][0][3][zzz] [3]	<b>Escala de Microondas</b> <b>Trimmer</b> Define até que faixa o canal de microondas irá funcionar. O máximo é 23 metros.
[2][0][3][zzz] [3][1]..[7]	<b>Opções da faixa de Microondas</b> 1) Mínimo                      3) 40%                      5) 80%                      7) Trimmer (A 2) 20%                      4) 60%                      6) Maximo                      sensibilidade do Microondas é definido pelo ajuste do trimmer no PCB)
[2][0][3][zzz] [4]	<b>Sensibilidade do Anti-Máscara</b> <b>Baixa Sensibilidade</b> Define a sensibilidade do Anti-máscara por Infravermelho Ativo
[2][0][3][zzz] [4][1]-[2]	<b>Opções do Anti-Máscara</b> 1) Baixa Sensibilidade    2) Alta Sensibilidade
[2][0][3][zzz] [5]	<b>Tipo de Lente</b> <b>Ângulo Aberto</b> Define a lente atual do detector.
[2][0][3][zzz] [5][1]..[2]	<b>Opções de tipos de Lentes</b> 1) Ângulo aberto    2) Barreira / Longo Alcance
[2][0][3][zzz] [6]	<b>Anti-Máscara</b> <b>Habilitado</b> Define a operação do sistema de detecção do Anti-Máscara
[2][0][3][zzz] [6][1]..[2]	<b>Opções do Anti-Máscara</b> 1) Desabilitado    2) Habilitado
[2][0][3][zzz] [7]	<b>Arme/Desarme</b> <b>Não</b> Define como será a operação dos led e da detecção anti-máscara quando o sistema estiver armado.
[2][0][3][zzz] [7][1]	<b>Não</b> O Anti-máscara por infravermelho ativo e a Anti-Proximidade estão habilitadas Os LED's funcionaram de acordo com os parâmetros programados
[2][0][3][zzz] [7][2]	<b>Sim</b> O Anti-máscara por infravermelho e a Anti-proximidade estão desabilitadas Os LED's estão desabilitados
[2][0][3][zzz] [8]	<b>Prox. AM</b> <b>Desabilitado</b> Define a operação do sistema de detecção do Anti-Máscara por Proximidade.
[2][0][3][zzz] [8][1]..[2]	<b>Opções do Prox. AM</b> 1) Desabilitado    2) Habilitado <b>NOTA:</b> Desabilite o Antimáscara por proximidade durante chuvas fortes (caso o WatchOUT RK315DT não esteja instalado em area coberta) para evitar alertas de Antimáscara por proximidade.









## Parâmetros do Sistema

### Sistema: Controle do Sistema

Teclas Rápidas	Parâmetros	Padrão de fábrica
[1][2][36]	<b>IR AM=Tamper</b>	<b>Não</b>
	Usado para determinar a operação da detecção de Anti-Mascaramento <b>Sim:</b> A detecção de Mascaramento ativará o alarme de tamper <b>Não:</b> A detecção de Mascaramento será considerada como ocorrência de problema.	
[1][2][37]	<b>PROX AM =Tamper</b>	<b>Não</b>
	Usado para habilitar a operação de detecção Anti-Máscara por proximidade indicado através do canal de Microondas. <b>Sim:</b> A detecção de Mascaramento por Proximidade ativará o alarme de tamper. <b>Não:</b> A detecção de Mascaramento por Proximidade será considerada como ocorrência de problema	

### Diagnósticos

A ProSYS possibilita a você testar os parâmetros que referem a operação do detector.

1. Através do menu principal do usuários aperte a tecla  [4] para acessar o menu de Manutenção.
2. Entre o código do Instalador (ou Sub-Instalador) e aperte a tecla  / .
3. Aperte as teclas [9] [1] para o menu de diagnósticos de zonas de BUS.
4. Entre o dígito da zona que você deseja testar e aperte a tecla  / . O Sistema irá fazer o diagnóstico e testes e listar os parâmetros dos testes, como indicado na tabela abaixo.
5. Use as teclas  /   /  para ver o resultado do diagnóstico.

### Menu do Usuário: 4) Manutenção → 9) Diagnósticos → 1) Zona BUS

Teclas Rápidas	Parâmetros
[4][9][1][zzz]	<p><b>Tensão de entrada do Detector:</b> Mostra a tensão de entrada do Detector.</p> <p><b>Nível do IVP 1:</b> Nível de DC do canal de IVP1, faixa de 0.1VDC - 4VDC</p> <p><b>Nível de ruído do IVP 1:</b> Nível de AC no canal de IVP1, faixa de 0VAC (Sem ruído) - 4VAC</p> <p><b>Nível do IVP 2:</b> Nível de DC do canal de IVP 2, faixa de 0.1VDC - 4VDC</p> <p><b>Nível de ruído do IVP 2:</b> Nível de AC no canal de IVP2, faixa de 0VAC (Sem ruído) - 4VAC</p> <p><b>Nível do Microondas 1:</b> Nível de DC do canal de microondas 1, faixa de 0.1VDC - 4VDC</p> <p><b>Nível de ruído no Microondas 1:</b> Nível de AC no canal de Microondas 1, faixa de 0VAC (Sem ruído) - 4VAC</p> <p><b>Nível do Microondas 2:</b> Nível de DC do canal de microondas 2, faixa de 0.1VDC - 4VDC</p> <p><b>Nível de ruído no microondas 2:</b> Nível de AC no canal de Microondas 2, faixa de 0VAC (Sem ruído) - 4VAC</p>

<b>Relaismodusinstallatie .....</b>	<b>86</b>
<b>Inleiding .....</b>	<b>86</b>
<b>Monteren .....</b>	<b>86</b>
Aandachtspunten in verband met de montage .....	86
Installatie van de wandhouder .....	87
Vlakke montage: .....	87
Montage in een hoek van 45° (linkerzijdemontage) .....	87
De positie van de rugbeveiliging wijzigen .....	88
<b>Bedraden van de klemmen.....</b>	<b>88</b>
<b>Instellingen van de DIP-switches .....</b>	<b>89</b>
<b>Microgolfafstelling .....</b>	<b>89</b>
Wandeltest.....	89
<b>Statussen van de LED's .....</b>	<b>89</b>
<b>Relaismodus- / BUS-modusjumper .....</b>	<b>90</b>
<b>Installeren van de standaardwartel .....</b>	<b>90</b>
Wandmontage .....	90
Montage van de wartelpijp.....	91
<b>Vervangen van lenzen .....</b>	<b>93</b>
Lenstypes .....	94
<b>Technische gegevens.....</b>	<b>95</b>
<b>Bestelinformatie .....</b>	<b>95</b>
<b>BUS-modusinstallatie .....</b>	<b>96</b>
<b>Inleiding .....</b>	<b>96</b>
<b>Bedraden van de klemmen.....</b>	<b>96</b>
<i>Deksel en rugbeveiliging .....</i>	<i>96</i>
<i>Beveiliging alleen afdekken .....</i>	<i>96</i>
<i>Beveiliging naar zone-ingang afdekken .....</i>	<i>96</i>
<b>Instellingen van de DIP-switches .....</b>	<b>96</b>
<b>Programmeren van ProSYS .....</b>	<b>97</b>
Toevoegen / verwijderen van de WatchOUT DT .....	97
Configureren van de WatchOUT DT-parameters .....	98
<b>Systeemparameters .....</b>	<b>99</b>

# Relaismodusinstallatie



## Inleiding

De Dual Technology-buitendetector WatchOUT 315DT van Risco Group is een unieke detector met signaalverwerking gebaseerd op twee passieve-infraroodkanalen (PIR) en twee microgolfsensoren (MW). De detector kan werken als een gewone relaisdetector aangesloten op een bedieningspaneel, of als een BUS-accessoire wanneer hij wordt aangesloten op het Risco Group ProSYS-bedieningspaneel via de RS485 BUS, waardoor hij unieke afstandsbedienings- en diagnosemogelijkheden krijgt.

De instructies in deze handleiding beschrijven de WatchOUT 315DT in relais- & BUS-modus. Voor gedetailleerde informatie betreffende BUS-modusinstallatie verwijzen wij u naar het hoofdstuk BUS Mode installation

## Monteren

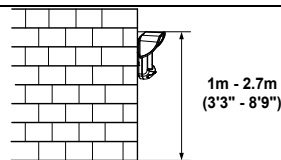
Aandachtspunten in verband met de montage

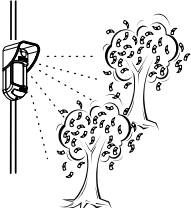
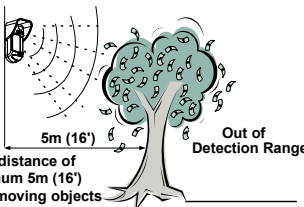
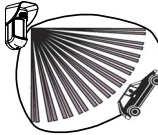
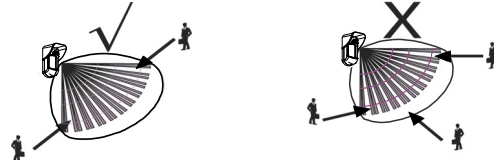
 <p>Optionele hoogte: 1m – 2,7m Typische hoogte: 2,2m Standaardlens: groothoeklens 15m (50°) 90° (RL300)</p> 	 <p>Voor zover mogelijk dient u te vermijden dat de detector naar bewegende voorwerpen wordt gericht (wiegende bomen, struiken, enz.)</p>
<p><b>Opmerking:</b></p> <ol style="list-style-type: none"><li>1. Voor installaties onder de 1,7m, waarbij huisdierimmunitieit is vereist, dient u de bijgeleverde RL300F-lens te gebruiken (installatie tegen lage muur of afsluiting).</li><li>2. De huisdierimmunitieit van de detector (hoogte van een dier, geen gewichtsbepanking) bedraagt maximaal 70 cm wanneer de detector op een hoogte van 2,2m wordt geïnstalleerd. Als de detector onder de bovengenoemde hoogte wordt geïnstalleerd, neemt de huisdierimmunitieit verhoudingsgewijs af; 10 cm verlaging van installatiehoogte resulteert in 10 cm minder huisdierimmunitieit.</li></ol>	 <p>Keep distance of minimum 5m (16') from moving objects</p> <p>Zorg ervoor dat het detectieveld voor beide technologieën niet wordt belemmerd door voorwerpen. Let daarbij op groeiende bomen of struiken, planten met grote, bewegende bladeren, enz.</p>
<p>Voor installaties met veel autoverkeer of doelen die zich buiten het vereiste detectiebereik bevinden, is het raadzaam de microgolfsensitiviteit (MW sensitivity) aan te passen en/of de detector neerwaarts te kantelen.</p> <p><b>Opmerking:</b> Het neerwaarts kantelen van de detector kan de huisdierimmunitieit doen afnemen</p>	
<p>Voor een optimale detectie dient u de montageplaats zo te kiezen dat een indringer die zich in een baan van 45° door het detectiegebied beweegt gemakkelijk onderscheept kan worden.</p>	
<p><b>Opmerking :</b> Schakel de Proximity AM uit tijdens hevige regen ( indien de WatchOUT 315DT niet beschermt is ) om Proximity AM alarmen te vermijden.</p>	

**Opmerking:**

De nummers van de installatie-uitbreekplaatjes worden aangegeven op de achterplaat.

1. Open het frontpaneel van de WatchOUT (ontgrendel C1, figuur 1).
2. Maak de inwendige basis los (ontgrendel I1, figuur 2).
3. Selecteer de montage-installatie als volgt:

**Vlakke montage:**

Verwijder de uitbreekplaatjes op de buitenbasis (figuur 3).

- B1 - B4: wandmontage-uitbreekplaatjes
- T1: rugbeveiligingsuitbreekplaatje
- W2 / W3: draaddoorvoeruitbreekplaatjes

**Montage in een hoek van 45° (linkerzijdemontage)**

e. Verwijder de uitbreekplaatjes op de buitenbasis (figuur 3)

- L1, L2: linkse montage-uitbreekplaatjes
- T3: links sabotage-uitbreekplaatje
- W5 / W6: draaddoorvoeruitbreekplaatjes

f. Verwijder de sabotageveer

g. Monteer de sabotagebeugel (item 1) opnieuw met de bijgeleverde platte sabotagebeugel (item 2).

Item 1                      Item 2



h. Steek sabotagehefboom B op T5 en T3 en draai schroef A vast (figuur 3)

4. Steek de buitendraden door buitenbasis W2, W3 (vlakke montage) of W5, W6 (linkerzijdemontage)(figuur 3).

5. Bevestig de buitenbasis tegen de muur.

6. Steek de buitendraden en de sabotagedraden door de inwendige basis (figuur 4).

7. Bevestig de inwendige basis aan de buitenbasis (vergrendel I1, figuur 2).

8. Sluit het frontpaneel (vergrendel C1, figuur 1) na het bedraden en het instellen van de DIP-switches.

9. Test de detector door middel van een wandtest.

**Opmerking:**

Voor een 45°-rechterzijde-installatie dient u de equivalente eenheden op de buitenbasis als volgt te gebruiken:

Figuur 1

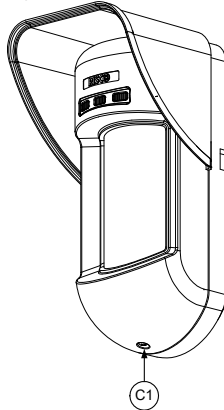

Figuur 2

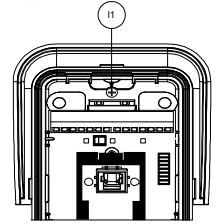

Figuur 3

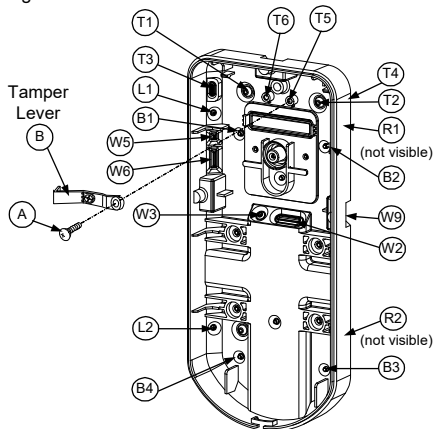

Figuur 4

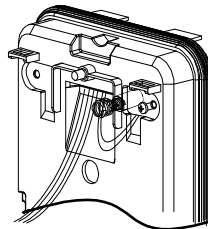

Beschrijving van de uitbreekplaatjes	Links	Rechts
Montage-uitbreekplaatjes	L1, L2	R1, R2
Sabotageveeruitbreekplaatjes	T1,T3	T2,T4
Sabotageschroefverankering	T5	T6
Draaddoorvoeruitbreekplaatjes	W5, W6	W7, W8

### De positie van de rugbeveiliging wijzigen

De rugbeveiliging wordt normaal bevestigd op de rechterzijde van de inwendige basis (langs achter bekeken). Als u deze naar de linkerzijde (langs achter bekeken) wenst te verplaatsen, dient u als volgt te werk te gaan (figuur 5):

1. Verwijder sabotageschroef 1 om de beveiliging los te maken in positie 7.
2. Zorg ervoor dat sabotageveer 2 zich boven sabotagedraadbasis 4 bevindt.
3. Zorg ervoor dat plastic sabotagebeugel 3 zich boven 2 en 4 bevindt.
4. Draai sabotageschroef 1 in 3 boven positie 6.

Figuur 5

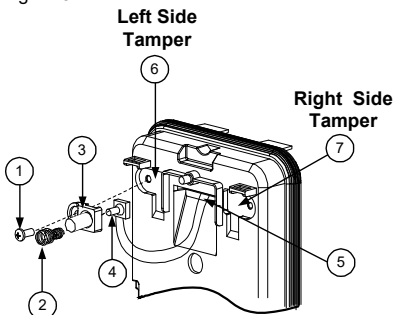

### Opmerkingen:

1. Vergewis u ervan dat u een "klik" hoort wanneer u de sabotageveer aan de wand bevestigt.
2. Voor een paalinstallatie kan de beveiliging worden verplaatst naar de rechteronderkant van de inwendige basis.

### Bedraden van de klemmen

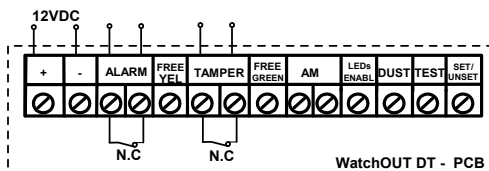

+, -	12 VDC
<b>ALARM</b>	Rustrelais, 24VDC , 0,1A
<b>FREE YEL</b>	Deze klem is een vrije pen die kan worden gebruikt om draden en EOL-weerstanden aan te sluiten
<b>TAMPER</b>	Rustrelais, 24VDC , 0,1A
<b>FREE GREEN</b>	Deze klem is een vrije pen die kan worden gebruikt om draden en EOL-weerstanden aan te sluiten
<b>AM</b>	Rust-AM-relaisuitgang (24VDC, 0,1A) wijst op een Anti Masking-alarm of een eventuele storing in de detector (niet: stof/vuile lens). Door het gebruik van beide microgolf kanalen, de nabijheid AM (anti-maskering) maakt een alarm van een sabotage poging voor dat de beschadiging of maskering van de detector kon gebeuren. <b>Opmerking:</b> Proximity AM: Wanneer DIP8 is ingesteld als ingeschakeld, opent dit relais ook als er een Proximity AM-poging plaatsvindt. In dit geval blijft het relais minstens 20 seconden geopend en wordt het na de bewegingsdetectie gesloten.
<b>LED ENABLE</b>	Gebruikt om de LED's op afstand te bedienen wanneer <b>DIP1</b> werd ingesteld op ON. Enable: ingangsspanning is +12V OF geen klemaansluiting Disable: sluit de ingang aan op 0V
<b>DUST</b>	N/A
<b>TEST</b>	Gebruikt voor het uitvoeren van een alarmtest op de detector door 0 volt op deze klem toe te passen. Geslaagd: alarmrelais wordt kortstondig geopend. Mislukt: AM-relais wordt geopend.



**SET/  
UNSET**

Deze ingang maakt het mogelijk om de werking van de Anti Masking en LED's te controleren naargelang de systeemstatus, Set (in paraatheid brengen) / Unset (paraatheid uitschakelen).

Terwijl het systeem paraat is, voorkomt deze functie dat een indringer de status van de detector kan te weten komen en inactieveert ze de Anti Masking-detectie.

Systeemstatus	Ingangstatus	AM-relais	LEDs
Set (in paraatheid brengen)	0V	Off	Off
Unset (paraatheid uitschakelen)	12V of geen verbinding	On*	On**

\* DIP7 is ON (Anti Masking actief).

\*\* DIP1 is ON (LEDs actief) en LEDs ENABLE-ingangsklem is actief (+12V OF geen klemverbinding).

## Instellingen van de DIP-switches

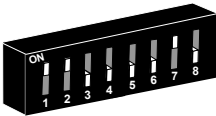

Fabriekswaarde

### DIP 1: werking van de LED's

On: LED's actief

Off: LED's inactief

### DIP 2-3: detectiegevoeligheid

Gevoeligheid	DIP2	DIP3
Laag	Off	Off
Medium	Off	On
Normaal (standaardwaarde)	On	Off
Maximum*	On	On

\* Bij een maximale gevoeligheid is wiegherkenning inactief om een maximale gevoeligheid tot stand te brengen.

### DIP 4: Anti Maskering gevoeligheid

On: Hoog

Off: Laag

### DIP 5: optische onderdelen van de detector

On: afsluiting / lange-afstandslens

Off: Groothoeklens

### DIP 6: rode LED /3 LED

On: alleen rode LED

Off: 3 LED's

### DIP 7: Anti Masking-werking

On: actief

Off: inactief

### DIP 8: Nabijheid AM

On: actief

Off: inactief

## Microgolfafstelling

Stel het microgolfbereik in met behulp van de trimmer op de PCB.

## Wandeltest

Twee minuten na het inschakelen van de voeding dient u de beveiligde zone te testen door middel van een wandeltest om na te gaan of de detector naar behoren werkt.

Voor installaties op oneffen oppervlakken dient u de PCB binnen de inwendige basis in de gepaste instelling te schuiven afhankelijk van de gewenste hoogte (1,0m, 1,5m, 2,2m, 2,7m) zoals afgedrukt in de linkerbenenhoek van de PCB of gebruik de standaardwartel.

Om het detectiebereik te verkleinen, schuift u de PCB opwaarts of kantelt u de wartel neerwaarts.

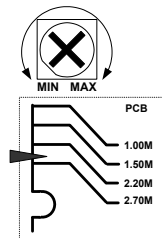

## Statussen van de LED's

LED	Status	Beschrijving
YELLOW	Brandt continu	Wijst op PIR-detectie
	Knippert	Wijst op AM-detectie (Anti Masking)
GREEN	Brandt continu	Wijst op MW-detectie (microgolf)
	Knippert	Het knipperen is teken van AM nabijheid detectie
RED	Brandt continu	Wijst op ALARM

	Knippert	Wijst op een gebrekkige communicatie met ProSYS (alleen BUS-modus)
<b>Alle LED's</b>	Knipperen (achter elkaar)	Apparaatinitialisatie na inschakelen

### Opmerkingen:

1. DIP-switch 1 moet in de stand ON staan om LED-indicaties mogelijk te maken.
2. Slechts één LED is actief op om het even welk ogenblik. Bijvoorbeeld, in geval van een gelijktijdige PIR- en MW-detectie brandt ofwel de GELE LED continu ofwel de GROENE LED (afhankelijk van welke detectie zich het eerst voordeed), gevolgd door de rode alarm-LED.
3. Om de detectie technologie analyses zoals Alarm, Anti-Maskering en AM Nabijheid te vermijden, plaats DIP Switch 6 (SW1) op ON. Alleen de rood LED zou geactiveerd worden.

### Relaismodus- / BUS-modusjumper

J-BUS-jumper (op de PCB tussen de rode en de groene LED's) wordt gebruikt om de werkingsmodus van de detector als volgt te bepalen:

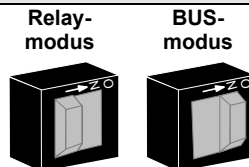

### Installeren van de standaardwartel

De buitendetector wordt geleverd met een standaardwartel voor een flexibele installatie. Volg de instructies hieronder om de detector te installeren met de standaardwartel:

1. Open het frontpaneel van de WatchOUT (ontgrendel C1, figuur 1).
2. Maak de inwendige basis los (ontgrendel I1, figuur 2).
3. Verwijder de uitbreekplaatjes op de buitenbasis (figuur 6, detail B).
  - W1: Draaddoorvoeruitbreekplaatjes
  - S1,S2: uitbreekplaatjes om de buitenbasis te bevestigen aan de standaardwartel
  - S3: uitbreekplaatje voor de borgschroef van de buitenbasis
4. Verwijder het relevante kabeldoorvoeruitbreekplaatje S2, S7 of S9 van de wartel (figuur 6, detail A).
5. Verwijder de rugbeveiliging van de inwendige basis (zie de paragraaf "Wijzigen van rugbeveiligingspositie") en verbindt hem met S5 (figuur 6, detail A) op de standaardwartel.

### Opmerking:

Vergewis u ervan dat u de gegraveerde **UP**-markering op het bovenste frontplaatje van de wartel ziet.

6. Selecteer het montage-installatietype als volgt:

#### Wandmontage

- a. Steek de externe draden door uitbreekopeningen S2, S7 of S9 en trek ze naar buiten (inclusief de sabotagedraden) doorheen de draaddoorveropening van de wartel (figuur 6, detail B).
- b. Bevestig de wartel tegen de muur met behulp van openingen S1, S3, S6 en S8.

## Montage van de wartelpijp (met behulp van de warteladapter voor metalen pijp - CSMA, figuur 6, detail A)

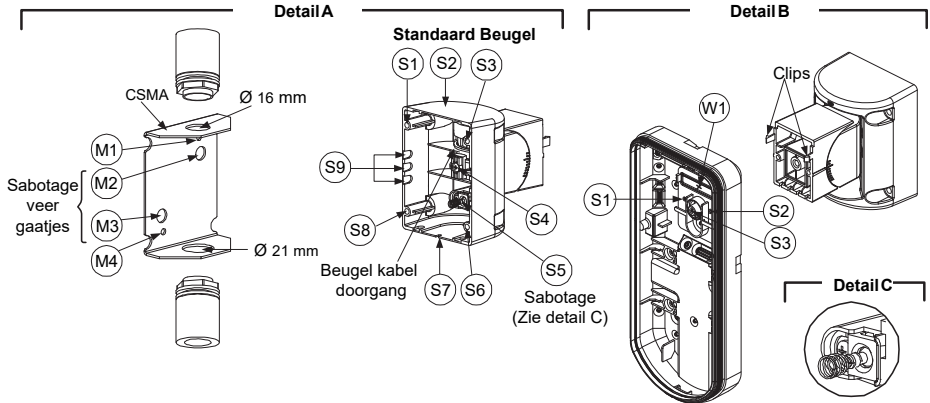

Figuur 6

### Opmerking:

De CSMA is vereist wanneer de bekabeling niet door de muur loopt maar door een beschermende pijp. De CSMA moet afzonderlijk worden besteld - P/N RA300SC0000A.

- Kies de richting waarop de CSMA moet worden gemonteerd naargelang de vereiste diameter: 16mm of 21mm.
- Steek de pijp in de CSMA.
- Bevestig de CSMA tegen de muur via de daartoe bestemde gaten (M1, M4).
- Steek de externe kabels en de sabotagekabels die uit de pijp komen door de wartelkabeldoorvoeropeningen van de wartel (figuur 6, detail A).
- Bevestig de wartel tegen de muur met behulp van openingen S1, S3, S6 en S8.

### Opmerking:

Sabotageveer S5 (figuur 7) moet in contact staan met de muur via sabotageveergaten M2 of M3 op de CSMA. Vergewis u ervan dat u een "klik" hoort bij het bevestigen aan de muur.

- Steek de sabotagedraden en de externe kabel van de standaardwartel door uitbreekopening W1 in de buitenbasis (figuur 6, detail B).
- Bevestig de buitenbasis aan de wartel door hem op de daartoe bestemde tongetjes te klikken.

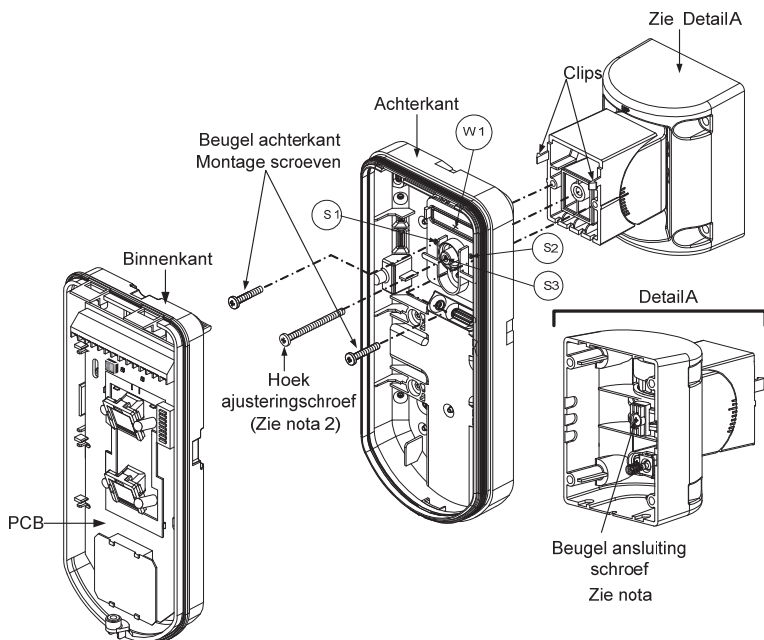

Figuur 8

**Opmerking:**

Draai de wartelmontageschroef niet los of vast aangezien die uitsluitend wordt gebruikt om de onderdelen van de wartel met elkaar te verbinden.

9. Bevestig de buitenbasis aan de wartel met twee schroeven die zijn bevestigd aan uitbreekopeningen S1 en S2 (figuur 8).
10. Steek de bijgeleverde hoekborgschroef van de buitenbasis door hoekborgschroefuitbreekopening S3 in de buitenbasis naar de standaardwartel (figuur 8).
11. Kantel en draai de standaardwartel in de gewenste stand. Eenmaal de standaardwartel zich in de gewenste stand bevindt, draait u de hoekborgschroef vast.
12. Plaats de inwendige basis op de buitenbasis. Steek alle kabels door de inwendige basis.
13. Bevestig de inwendige basis aan de buitenbasis (vergrendel I1, figuur 2).
14. Verstellen van de standaardwartel wanneer de PCB geïnstalleerd is (figuur 9):
  - a. Buig het zwarte schuim onder de RODE LED op de PCB naar beneden (genoeg om aan de wartelborgschroef te kunnen).
  - b. Gebruik een zeskantschroevendraaier om de borgschroef los te draaien (zie figuur 9).
  - c. Kantel en/of draai de standaardwartel in de gewenste stand.
  - d. Draai de hoekborgschroef vast.

**Opmerking:**

Wanneer de merktekens op de twee beweegbare onderdelen tegenover elkaar staan (figuur 8), bevindt de standaardwartel zich verticaal/horizontaal in de 0-stand. Iedere klik vanuit die stand komt overeen met 5 in verticale / horizontale stand.

15. Sluit het frontpaneel (vergrendel C1, figuur 1) en test de detector met de wandeltest.

**Opmerking:**

De schroef moet door de buitenbasis gaan en in de wartel worden vastgedraaid.

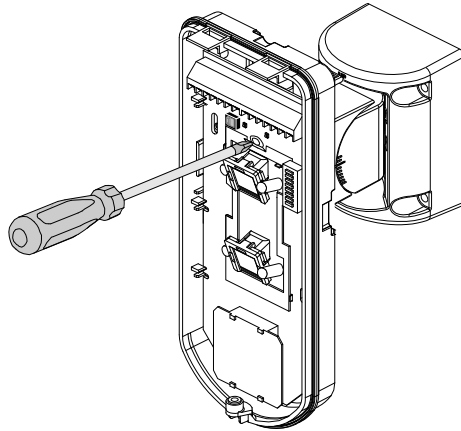

Figuur 9

## Vervangen van lenzen

1. Draai de zes schroeven waarmee de lenshouder is bevestigd uit de achterkant van het frontpaneel.
2. Om de lenshouder los te maken, drukt u voorzichtig op de lens langs de buitenzijde van het frontpaneel.
3. Maak de lens los uit de lenshouder door voorzichtig te drukken op de lipjes waarmee ze vastzit in de houder.
4. Vervang de lens. Steek de 4 lipjes van de lens in de daartoe bestemde openingen in de houder.
5. Breng de lenshouder opnieuw aan op het frontpaneel. Let er daarbij op dat de lenshouder op de dichtingsrubber rust.
6. Installeer de 6 bevestigingsschroeven opnieuw.

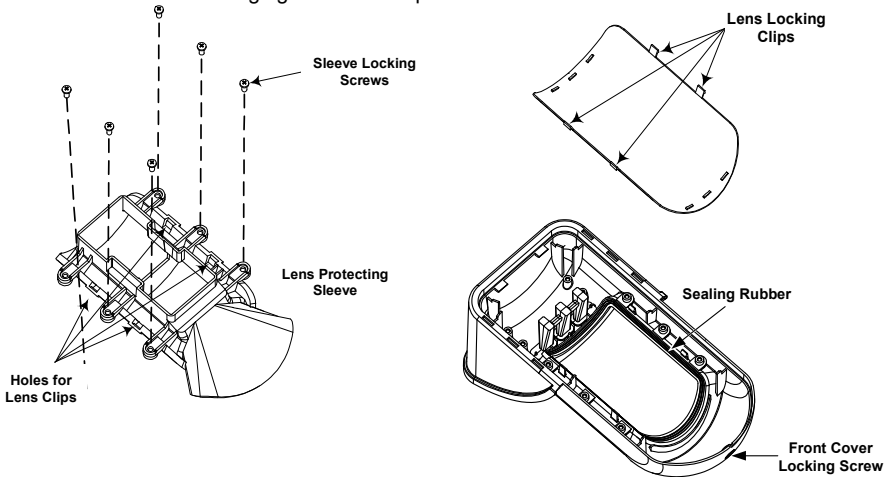

## Lenstypes

### Groothoeklens (RL300) / Lage installatie - huisdierlens (RL300F)

#### Bovenaanzicht

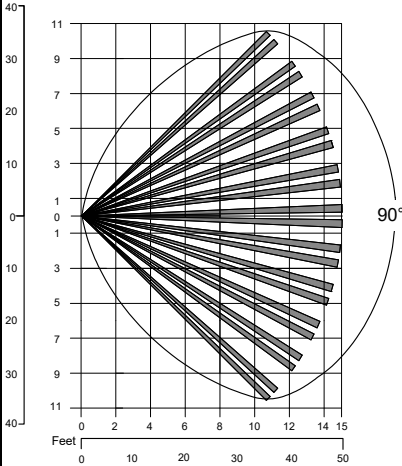

### Groothoeklens (RL300): Zijaanzicht

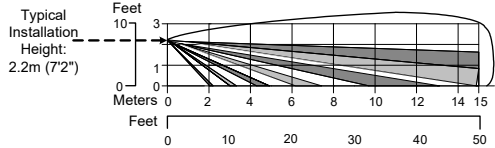

### Lage installatie - huisdierlens (RL300F) : Zijaanzicht

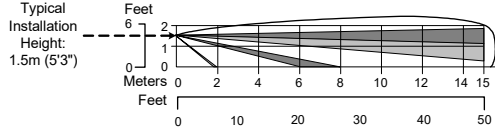

### Opmerking:

De huisdierimmunitieit van de detector (hoogte van een dier, geen gewichtsbepanking) bedraagt maximaal 70 cm wanneer de detector op een hoogte van 2,2m wordt geïnstalleerd. Als de detector onder de bovengenoemde hoogte wordt geïnstalleerd, neemt de huisdierimmunitieit verhoudingsgewijs af; 10 cm verlaging van installatiehoogte resulteert in 10 cm minder huisdierimmunitieit.

### Lange-afstandslens (RL300LR): Bovenaanzicht

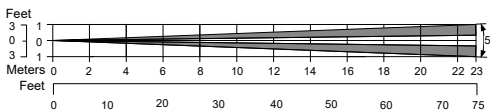

### Lange-afstandslens (RL300LR): Zijaanzicht

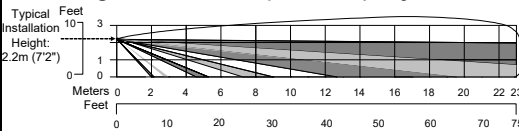

### Afsluitlens (RL300B): Bovenaanzicht

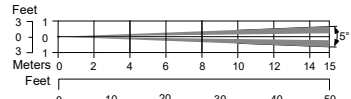

### Afsluitlens (RL300B): Zijaanzicht

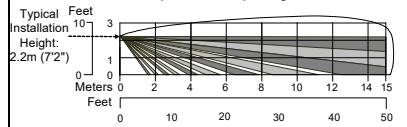

## Technische gegevens

Elektrisch	
Stroomverbruik	30mA bij 12 VDC (Stand by)
	42mA bij 12 VDC (MAX met LED AAN)
Spanningsvereisten	9 -16 VDC
Alarmcontacten	24 VDC, 0,1A
AM-contacten	24 VDC, 0,1A
Stofuitgang	Open collector 70mA max.
Stroomuitgang	10.587GHZ: 10dbm Typ.
Frequentie	10.587GHZ
Fysisch	
Afmetingen: LxBxD	230 x 123 x 123mm
Gewicht	0,632 Kg
Gebruiksomgeving	
RF-immuniteit	In lijn met de EN50130-4 normering
Bedrijfs-/opslagtemperatuur	-30°C tot 60°C

## Bestelinformatie

### Standaardapparaten

Modelleren	Beschrijving
WatchOUT 315DT	WatchOUT DT 10,525GHz + wartel
<b>Opmerking:</b>	
Elk van de detectors bevat een standaardwartel en 3 vervanglenzen (P/N gegraveerd op de lens) 1,7m lage installatie huisdier (RL300F), lange-afstands- (RL300R) en afsluitlens (RL300B).	

### Accessoirekits

Modelleren	Beschrijving	Gewicht
RA300B	WatchOUT Afsluitingswartelkit	0,1 Kg
RA300P	WatchOUT-paaladapterkit	0,25 Kg
RA300C	WatchOUT-pijpadapterkit	0,6 Kg
RA300HS	WatchOUT-demobehuizing	- -
RA300SC	WatchOUT-warteladapter voor metalen pijp	1Kg

### Cameraoptie

Modelleren	Beschrijving
WatchOUT VC1	WatchOUT-camerakapadapter
WatchOUT VC017	Smalfilmcamera voor WatchOUT
WatchOUT VC053	Groothoekcamera voor WatchOUT
WatchOUT VCPS	WatchOUT 220V-cameravoeding
WatchOUT VCPS	WatchOUT 120V-cameravoeding

## BUS-modusinstallatie

### Inleiding

De informatie in dit hoofdstuk heeft uitsluitend betrekking op de installatie van de WatchOUT 315DT in BUS-modus. Er kunnen maximaal 32 busdetectors worden geïnstalleerd op de ProSYS RS485-bus, wat bekabelingstijd uitspaart en afstandsbedienings- en diagnosemogelijkheden creëert.

### Bedraden van de klemmen

<b>+, -</b>	Gebruikt voor aansluiting van een 12V DC-voeding. Verbind de (+) klem met de AUX RED en de (-) klem met de COM BLK van de ProSYS-klemmen
<b>YELLOW</b>	Gebruikt voor datacommunicatie met de ProSYS. Aansluiten op de klem naar de <b>BUS YEL</b> van de ProSYS
<b>GREEN</b>	Gebruikt voor datacommunicatie met de ProSYS. Aansluiten op de klem naar de <b>BUS GRN</b> van de ProSYS
<b>TAMPER</b>	Gebruikt voor de bekabeling voor de sabotagedetectie, zie verder
<b>LED ENABLE</b>	Gebruikt voor de bekabeling voor de sabotagedetectie, zie verder
<b>Opmerking:</b>	
Alle klemmen die niet worden vermeld in de bovenstaande tabel worden niet gebruikt.	

#### Deksel en rugbeveiliging

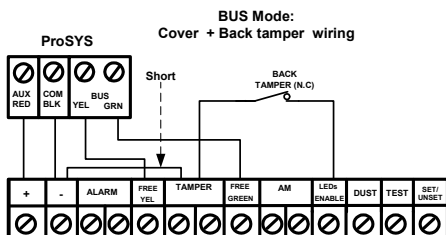

#### Beveiliging alleen afdekken

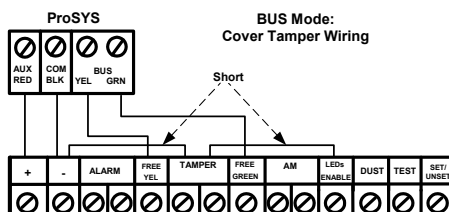

#### Beveiliging naar zone-ingang afdekken

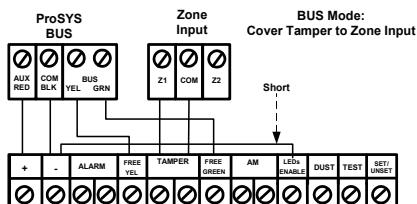

### Instellingen van de DIP-switches

DIP-switchnummer	Beschrijving
1 - 5	Gebruikt voor het instellen van het detector-ID-nummer. Stel het ID-nummer op dezelfde wijze in als voor om het even welk ander ProSYS-accessoire (kijk in de ProSYS-installatiehandleiding)
6 - 8	Niet gebruikt



**WatchOUT ID: DIP-switches 1 - 5**

ID	1	2	3	4	5
01	OFF	OFF	OFF	OFF	OFF
02	ON	OFF	OFF	OFF	OFF
03	OFF	ON	OFF	OFF	OFF
04	ON	ON	OFF	OFF	OFF
05	OFF	OFF	ON	OFF	OFF
06	ON	OFF	ON	OFF	OFF
07	OFF	ON	ON	OFF	OFF
08	ON	ON	ON	OFF	OFF
09	OFF	OFF	OFF	ON	OFF
10	ON	OFF	OFF	ON	OFF
11	OFF	ON	OFF	ON	OFF
12	ON	ON	OFF	ON	OFF
13	OFF	OFF	ON	ON	OFF
14	ON	OFF	ON	ON	OFF
15	OFF	ON	ON	ON	OFF
16	ON	ON	ON	ON	OFF

ID	1	2	3	4	5
17	OFF	OFF	OFF	OFF	ON
18	ON	OFF	OFF	OFF	ON
19	OFF	ON	OFF	OFF	ON
20	ON	ON	OFF	OFF	ON
21	OFF	OFF	ON	OFF	ON
22	ON	OFF	ON	OFF	ON
23	OFF	ON	ON	OFF	ON
24	ON	ON	ON	OFF	ON
25	OFF	OFF	OFF	ON	ON
26	ON	OFF	OFF	ON	ON
27	OFF	ON	OFF	ON	ON
28	ON	ON	OFF	ON	ON
29	OFF	OFF	ON	ON	ON
30	ON	OFF	ON	ON	ON
31	OFF	ON	ON	ON	ON
32	ON	ON	ON	ON	ON

**Programmeren van ProSYS**

Het volgende hoofdstuk beschrijft de bijkomende softwareprogrammeeropties die werden toegevoegd aan de ProSYS-software en die betrekking hebben op de instellingen van de WatchOUT DT als een BUS-detector. Er kunnen maximaal 32 BUS-detectors worden toegevoegd aan het systeem (16 in ProSYS 16) en elk van die detectors gaat ten koste van een zone in het systeem.

Het verdient aanbeveling de ProSYS-installatiehandleidingen en -gebruiksaanwijzingen te lezen en volledig te begrijpen alvorens de WatchOUT te programmeren

**Opmerkingen:**

De WatchOUT is compatibel met de ProSYS-software versie 4.xx en hoger.

De WatchOUT kan worden geprogrammeerd via de U/D-software vanaf UD-versie 1.8 en hoger.

Voor een maximale werkingsstabiliteit is het raadzaam een totale kabellengte van 300 meter NIET te overschrijden bij het aansluiten van de WatchOUT op de BUS

**Toevoegen / verwijderen van de WatchOUT DT**

De WatchOUT behoort tot een nieuwe categorie van accessoires, de BUS-zones. Daarom is het toevoegen/verwijderen van de WatchOUT identiek aan om het even welk ander accessoire met de volgende uitzonderingen:

**iedere BUS-zonedetector moet worden toegewezen aan een Gewone Zone.**

Iedere BUS-detector kan worden toegewezen aan een fysisch bekabelde zone of aan een virtuele zone.

**Fysische zone:** om het even welke zone op de ProSYS PCB (zones 1-8) of op een bekabelde zone-uitbreider (ZE08, ZE16).

**Virtuele zone:** om het even welke zone op een BUS-zone-uitbreider gedefinieerd als BZ08 of BZ16.



**Opmerkingen:**

Virtuele BUS-zones zijn kostenbesparend. Ze maken het mogelijk uw systeemzones uit te breiden zonder de toevoeging van fysische zone-uitbreiders.

De virtuele BUS-zone-uitbreider kan alleen voor BUS-zonedetectors worden gebruikt.



Om een BUS-zone-uitbreider toe te voegen, selecteert u type BZ08 of BZ16 bij het toevoegen van een zone-uitbreider (sneltoets [7][1][2]).

## 1. Toevoegen / verwijderen van de WatchOUT DT

1. Vanuit het installatiemenu gaat u naar het menu Add/Delete (toevoegen/verwijderen): sneltoets **[7][1][9][5]** voor BUS-zonedetectors
2. Gebruik de toetsen  of  om de cursor boven het buszone-ID-nummer te plaatsen waarvoor u een detector wenst toe te wijzen (of te verwijderen).

### Opmerking:

Vergewis u ervan dat het fysieke ID-nummer van de detector identiek is aan het ID-nummer dat u selecteert bij het programmeren.

3. Plaats de cursor in het veld TYPE en gebruik de toets  om ODT15 te selecteren voor de WatchOUT DT-detector.
4. Druk op  om te bevestigen.
5. Herhaal dat proces voor de andere BUS-detectors.

## 2. De WatchOUT DT toewijzen aan een zone

1. Selecteer in het hoofdinstallatiemenu de optie Zones: One by One (zones: een voor een) (sneltoets **[2][1]**)
2. Selecteer het zonennummer waar u de BUS detector aan wenst toe te wijzen.

### Opmerking:

Als u een BUS-zone-uitbreider definieerde, selecteert u een zonennummer uit de virtuele zones (gedefinieerd door de BUS-zone-uitbreider).

3. Definieer Partitions (secties), Groups (groepen), Zone Type (zonetype) en Zone Sound (zonegeluid).
4. In de categorie Termination selecteert u [5] Bus Zone gevolgd door . Het volgende verschijnt:

Z:001	LINK TO:
ID:01	TYPE=ODT15

5. Selecteer het BUS-zonennummer dat u aan de geprogrammeerde zone wenst toe te wijzen. Het veld Type zal automatisch worden bijgewerkt wanneer u de BUS-zone selecteert.
6. Druk op . De categorie loop response (lusrespons) is niet van toepassing op een BUS-zone en het volgende verschijnt:

Z:001	RESPONSE:
N/A-BUS_ZONE	

7. Druk op , wijs een label toe en druk op .

## 3. Configureren van de WatchOUT DT-parameters

1. Om de WatchOUT-insteloptie op te roepen, drukt u op **[2][0][3]** in het hoofdinstallatiemenu. Het volgende verschijnt:

B-ZONE PRMS:
ZONE#=001 (M:ZZ)

2. Selecteer de zone waaraan de BUS-zone werd toegewezen en druk op . U kunt de WatchOUT-parameters nu als volgt programmeren:

## Zones gemengd: BUS-zone

Sneltoetsen	Parameter	Standaard
[2][0][3][zzz] [2][1][1]	<b>LED'S</b> Definieert de werkingsmodus van de LED'S.	<b>3 LED'S</b>
[2][0][3][zzz] [1][1]	<b>Off</b> Blokkeert de werking van de LED's.	
[2][0][3][zzz] [1][2]	<b>Red Only (alleen rood)</b> Alleen de rode led werkt. Deze optie wordt ten stelligste aanbevolen om de mogelijkheid uit te sluiten dat de indringer het gedrag van de detector kan "leren".	
[2][0][3][zzz] [1][3]	<b>3 LED'S</b> Alle 3 de LED's werken.	
[2][0][3][zzz] [2]	<b>PIR Sensitivity (PIR-gevoeligheid)</b> Definieert de gevoeligheid van de detector (MW + PIR).	<b>Normaal</b>
[2][0][3][zzz] [2][1]..[4]	<b>Sensitivity Options (gevoelighedsopties)</b> 1) Laag                      3) Normaal 2) Medium                    4) Hoog	
[2][0][3][zzz] [3]	<b>MW-bereik</b> Definieert het microgolfkanaalbereik. Het maximumbereik is 23m.	<b>Trimmer</b>
[2][0][3][zzz] [3][1]..[7]	<b>MW-bereikopties</b> 1) Minimum                3) 40%                    5) 80%                    7) Trimmer (MW wordt gedefinieerd door de trimmerinstelling op de PCB) 2) 20%                        4) 60%                    6) Maximum	
[2][0][3][zzz] [4]	<b>Anti-Maskering gevoeligheid</b> Bepaalt het gevoeligheid aan de actieve IR Anti_Maskering	<b>Laag gevoeligheid</b>
[2][0][3][zzz] [4][1]..[2]	<b>Anti-Maskering gevoeligheid opties</b> 1) Laag gevoeligheid    2) Hoog gevoeligheid	
[2][0][3][zzz] [4][2]	<b>PIR or Microwave (PIR of microgolf)</b> Er wordt een alarm geactiveerd wanneer één van beide kanalen (PIR of MW) een alarm detecteert (OR-logica).	
[2][0][3][zzz] [5]	<b>Lens Type (lenstype)</b> Definieert de eigenlijke lens van de detector.	<b>Wide Angle (groothoek)</b>
[2][0][3][zzz] [5][1]..[2]	<b>Lens Type Options (lenstype-opties)</b> 1) Wide Angle (groothoeklens)    2) Barrier / Long Range (Afsluit-/lange-afstandslens)	
[2][0][3][zzz] [6]	<b>Anti-Mask</b> Bepaalt de werking van de Anti Masking-detectie.	<b>Enable</b>
[2][0][3][zzz] [6][1]..[2]	<b>Anti-Mask Options</b> 1) Disable    2) Enable (standaardinstelling)	
[2][0][3][zzz] [7]	<b>Arm/Disarm (in/uit paraatheid schakelen)</b> Bepaalt de werking van de LED's Anti Masking-detecties wanneer de detector paraat is.	<b>No (nee)</b>
[2][0][3][zzz] [7][1]	<b>No (nee)</b> Actieve IR Anti-Maskering en Proximity Anti-Maskering zijn in werking LEDs volgens de LEDs instelling	
[2][0][3][zzz] [7][2]	<b>Yes (ja)</b> Actieve IR Anti-Maskering en Proximity Anti-Maskering is gedeactiveerd LEDs zijn gedeactiveerd	
[2][0][3][zzz] [8]	<b>Prox. AM</b> Bepaalt de werking van de nabijheid Anti Maskering-detectie.	<b>Disable</b>
[2][0][3][zzz] [8][1]..[2]	<b>Prox. AM Options</b> 1) Disable (standaardinstelling)    2) Enable <b>Opmerking</b> : Schakel de Proximity AM uit tijdens hevige regen ( indien de WatchOUT 315DT niet beschermt is ) om Proximity AM alarmen te vermijden.	





## Systemparameters

Systeem: systeemcontrole

Sneltoetsen	Parameter
[1][2][36]	<p><b>AM=Sabotage</b> <span style="float: right;"><b>Standaardwrde: No (nee)</b></span></p> <p>Om de keuze te maken met de Anti Maskering detectie  <b>Yes (Ja):</b> Anti maskering detectie zou een sabotage alarm activeren.  <b>No (Nee):</b> Anti maskering detectie zou een fout gebeurtenis produceren.</p>
[1][2][37]	<p><b>PROX AM =Sabotage</b> <span style="float: right;"><b>No (nee)</b></span></p> <p>Om de keuze te maken met de nabijheid Anti Maskering detectie  <b>Yes (Ja):</b> Nabijheid Anti Maskering detectie zou een sabotage alarm activeren.  <b>No (Nee):</b> Nabijheid Anti Maskering detectie zou een fout gebeurtenis produceren.</p>

### Diagnostics (diagnosefunctie)

De ProSYS stelt u in staat de parameters die de werking van de **detector** weergeven te testen.

1. Druk in het hoofdgebruikersmenu op  [4] om het menu Maintenance (onderhoud) op te roepen.
2. Voer de installateurcode (of subinstallateurcode) in en druk op .
3. Druk op [9] [1] voor het Bus Zones-diagnosemenu.
4. Voer het cijfer in van de zone die u wenst te testen en druk vervolgens op . Het systeem voert de diagnostetest uit en er verschijnt een lijst van testparameters, zoals aangegeven in de onderstaande tabel.
5. Gebruik de toetsen   om de diagnostetestresultaten te bekijken

**Gebruikersmenu: 4) Maintenance (onderhoud) → 9) Diagnostic (diagnose) → 1) Bus Zone**

Sneltoetsen	Parameter
[4][9][1][zzz]	<p>Detector Input Voltage (detectoringangsspanning): geeft de ingangsspanning van de detector weer.</p> <p><b>PIR 1 Level (PIR 1-niveau):</b> DC-niveau van PIR-kanaal 1. Bereik 0,1v - 4v</p> <p><b>PIR 1 Noise Level (PIR 1-ruisniveau):</b> AC-niveau van PIR-kanaal 1. Bereik 0VAC (geen ruis) - 4VA</p> <p><b>PIR 2 Level (PIR 1-niveau):</b> DC-niveau van PIR-kanaal 2. Bereik 0,1v - 4v</p> <p><b>PIR 2 Noise Level (PIR 1-ruisniveau):</b> AC-niveau van PIR-kanaal 2. Bereik 0VAC (geen ruis) - 4VA</p> <p><b>MW 1 Level (MW 1-niveau):</b> DC-niveau MW-kanaal 1 bereik 0,1v - 4v</p> <p><b>MW 1 Noise Level (MW 1-ruisniveau):</b> AC-niveau MW-kanaal 1 AC (0VAC (geen ruis) - 4VAC)</p> <p><b>MW 2 Level (MW 1-niveau):</b> DC-niveau MW-kanaal 2 bereik 0,1v - 4v</p> <p><b>MW 2 Noise Level (MW 1-ruisniveau):</b> AC-niveau MW-kanaal 2 AC (0VAC (geen ruis) - 4VAC)</p>

## WatchOUT 315DT FCC Compliance Section (US version):

### FCC Part 15 Note:

This equipment has been tested and found to comply with the limits for a Class B digital device, pursuant to Part 15 of the FCC rules. These limits are designed to provide reasonable protection against harmful interference in a residential installation. This equipment generates, uses and can radiate radio frequency energy and, if not installed and used in accordance with the instructions, may cause harmful interference to radio communications. However, there is no guarantee that interference will not occur in a particular installation. If this equipment does cause harmful interference to radio or television reception, which can be determined by turning the equipment off and on, the user is encouraged to try to correct the interference by one or more of the following measures:

- ✦ Reorient or relocate the receiving antenna.
- ✦ Increase the separation between the equipment and receiver.
- ✦ Connect the equipment to an outlet on a circuit different from that to which the receiver is connected.
- ✦ Consult the dealer or an experienced radio/TV technician.

### FCC Warning:

The manufacturer is not responsible for any radio or TV interference caused by unauthorized modifications to this equipment. Such modifications could void the user's authority to operate the equipment.

FCC ID: JE41CAV005

## CE Compliance Section (European and German versions):

Risco Ltd. hereby declares that this equipment is in compliance with the essential requirements and other relevant provisions of Directive 1999/5/EC. For the CE Declaration of Conformity please refer to our website: [www.riscogroup.com](http://www.riscogroup.com).



### WatchOUT 315DT applicable countries (European version):

<del>AT</del>	BE	CY	<del>CZ</del>	DK
<del>EE</del>	<del>FI</del>	FR	<del>DE</del>	GR
HU	IE	IT	LV	LT
LU	MT	NL	PL	PT
<del>SE</del>	SL	ES	<del>SK</del>	GB
BG	RO	<del>TR</del>	CH	NO

### WatchOUT 315DT applicable countries (German Version):

AT, CZ, SL, DE, TR, RU, EE



## **RISCO Group Limited Warranty**

RISCO Group and its subsidiaries and affiliates ("Seller") warrants its products to be free from defects in materials and workmanship under normal use for 24 months from the date of production. Because Seller does not install or connect the product and because the product may be used in conjunction with products not manufactured by the Seller, Seller cannot guarantee the performance of the security system which uses this product. Seller's obligation and liability under this warranty is expressly limited to repairing and replacing, at Seller's option, within a reasonable time after the date of delivery, any product not meeting the specifications. Seller makes no other warranty, expressed or implied, and makes no warranty of merchantability or of fitness for any particular purpose.

In no case shall seller be liable for any consequential or incidental damages for breach of this or any other warranty, expressed or implied, or upon any other basis of liability whatsoever.

Seller's obligation under this warranty shall not include any transportation charges or costs of installation or any liability for direct, indirect, or consequential damages or delay.

Seller does not represent that its product may not be compromised or circumvented; that the product will prevent any personal injury or property loss by burglary, robbery, fire or otherwise; or that the product will in all cases provide adequate warning or protection.

Seller, in no event shall be liable for any direct or indirect damages or any other losses occurred due to any type of tampering, whether intentional or unintentional such as masking, painting or spraying on the lenses, mirrors or any other part of the detector.

Buyer understands that a properly installed and maintained alarm may only reduce the risk of burglary, robbery or fire without warning, but is not insurance or a guaranty that such event will not occur or that there will be no personal injury or property loss as a result thereof.

Consequently seller shall have no liability for any personal injury, property damage or loss based on a claim that the product fails to give warning. However, if seller is held liable, whether directly or indirectly, for any loss or damage arising under this limited warranty or otherwise, regardless of cause or origin, seller's maximum liability shall not exceed the purchase price of the product, which shall be complete and exclusive remedy against seller.

No employee or representative of Seller is authorized to change this warranty in any way or grant any other warranty.

**WARNING:** This product should be tested at least once a week.

### **RED Compliance Statement:**

Hereby, RISCO Group declares that this equipment is in compliance with the essential requirements and other relevant provisions of Directive 2014/53/EU. For the CE Declaration of Conformity please refer to our website: [www.riscogroup.com](http://www.riscogroup.com).

## Contacting RISCO Group

RISCO Group is committed to customer service and product support. You can contact us through our website ([www.riscogroup.com](http://www.riscogroup.com)) or at the following telephone and fax numbers:

### United Kingdom

Tel: +44-161-655-5500

E-mail: [support-uk@riscogroup.com](mailto:support-uk@riscogroup.com)

### Italy

Tel: +39-02-66590054

E-mail: [support-it@riscogroup.com](mailto:support-it@riscogroup.com)

### Spain

Tel: +34-91-490-2133

E-mail: [support-es@riscogroup.com](mailto:support-es@riscogroup.com)

### France

Tel: +33-164-73-28-50

E-mail: [support-fr@riscogroup.com](mailto:support-fr@riscogroup.com)

### Belgium

Tel: +32-2522-7622

E-mail: [support-be@riscogroup.com](mailto:support-be@riscogroup.com)

### USA

Tel: +1-631-719-4400

E-mail: [support-usa@riscogroup.com](mailto:support-usa@riscogroup.com)

### China (Shanghai)

Tel: +86-21-52-39-0066

E-mail: [support-cn@riscogroup.com](mailto:support-cn@riscogroup.com)

### Israel

Tel: +972-3-963-7777

E-mail: [support@riscogroup.com](mailto:support@riscogroup.com)

This RISCO product was purchased at:

All rights reserved.

No part of this document may be reproduced in any form without prior written permission from the publisher.



*Only P/N: RK315DT00USB is UL approved*