

TECHNICAL MANUAL

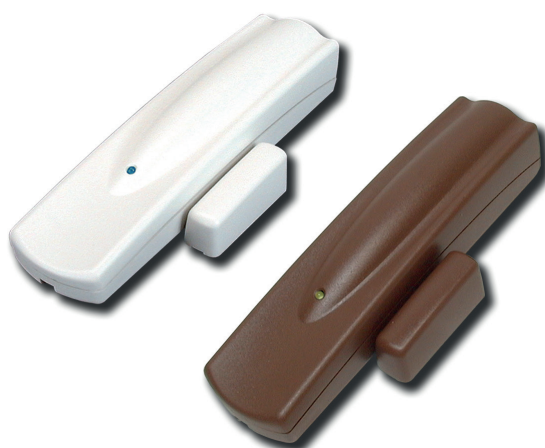

LUPUS2K - VOLANS2K AND BROWN VERSIONS

Radio transmitters for wireless NG-TRX
intrusion detection systems

090001113



IMQ-SISTEMI DI SICUREZZA

IT08020000001624



EL.MO. SPA



FOREWORD

FOR THE INSTALLER:

Comply strictly with current standards governing the installation of electrical systems and security systems, and with the manufacturer's directions given in the manuals supplied with the products.

Provide the user with full information on using the system installed and on its limitations, pointing out that there are different levels of security performance that will need to suit the user's requirements within the constraints of the specific applicable standards. See that the user looks through the warnings given herein.

FOR THE USER:

Check the system's operation thoroughly at regular intervals, making sure the equipment can be armed and disarmed properly.

Make sure the system receives proper routine maintenance, employing the services of specialist personnel who meet the requirements prescribed by current regulations.

Ask your installer to check that the system suits changing operating conditions (e.g. changes in the extent of the areas to be protected, change in access methods, etc...).

This device has been designed, built and tested with the utmost care and attention, adopting test and inspection procedures in accordance with current legislation. Full compliance of the working specifications is only achieved in the event the device is used solely for its intended purpose, namely:

Radio transmitters for wireless NG-TRX intrusion detection systems

The device is not intended for any use other than the above and hence its correct functioning in such cases cannot be assured.

Consequently, any use of the manual in your possession for any purpose other than those for which it was compiled - namely for the purpose of explaining the product's technical features and operating procedures - is strictly prohibited.

Production processes are closely monitored in order to prevent faults and malfunctions. However, the componentry adopted is subject to an extremely modest percentage of faults, which is nonetheless the case with any electronic or mechanical product.

Given the intended use of this item (protection of property and people), we invite you to adapt the level of protection offered by the system to suit the actual situation of risk (allowing for the possibility of impaired system operation due to faults or other problems), while reminding you that there are specific standards for the design and production of systems intended for this kind of application.

We hereby advise you (the system's operator) to see that the system receives regular routine maintenance, at least in accordance with the provisions of current legislation, and also check on as regular a basis as the risk involved requires that the system in question is operating properly, with particular reference to the control unit, sensors, sounders, dialler(s) and any other device connected. You must let the installer know how well the system seems to be operating, based on the results of periodic checks, without delay.

Work involved in the design, installation and maintenance of systems incorporating this product should be performed only by personnel with suitable skills and knowledge required to work safely so as to prevent any accidents. It is vital that systems be installed in accordance with current legislation. The internal parts of certain equipment are connected to the mains and therefore there is a risk of electrocution when maintenance work is performed inside without first disconnecting the primary and emergency power supplies. Certain products include batteries, rechargeable or otherwise, as an emergency backup power supply. If connected incorrectly, they may cause damage to the product or property, and may endanger the operator (explosion and fire).

EU DECLARATION OF CONFORMITY

Hereby, EL.MO. S.p.A. declares that the radio equipment LUPUS2K - VOLANS2K is in compliance with Directive 2014/53/EU. The full text of the EU declaration of conformity is available at the following Internet address: elmospa.com – registration is quick and easy.

DISPOSAL INSTRUCTIONS - INFORMATION FOR THE USER



IT08020000001624

In accordance with Directive 2012/19/EU on waste electrical and electronic equipment (WEEE), please be advised that the EEE was placed on the market after 13 August 2005 and must be disposed of separately from normal household waste.

This product needs batteries for correct functioning. Exhausted batteries have to be delivered to dumping grounds authorized for battery collection. The materials used for this product are very harmful and polluting if dispersed in the environment.



1. GENERALS

LUPUS2K and VOLANS2K are compact transmitters used for the control of fixtures or for perimetral protections. These transmitters can be integrated in wireless systems managed by VIDOMO2K and VICOMPACT2K control units (belonging to the NG-TRX system) or by other expressly compatible control unit models.

Their general features can be summarized as follows:

- **LUPUS2K** can transmit the state variations of magnetic contacts and of the roll-up shutter sensor wired to its terminals. LUPUS2K is identified by the control unit as a multi-channel device; it occupies up to 3 zones for the transmission of the anomaly/alarm states of the REED magnetic contact (located on housing side), the magnetic contact wired to the terminal board and the roll-up shutter detector connected to the proper terminal. For the latter, you can properly configure the number of pulses in a time slot. The detector is fully configurable via software.
- **VOLANS2K** can transmit the state variations of magnetic contacts and of the roll-up shutter sensor connected via wires to its terminals. VOLANS2K is identified by the control unit as a multi-channel device; it occupies up to 4 zones for the transmission of the anomaly/alarm states of the REED magnetic contact (located on housing side), the magnetic contact wired to the terminal board, the roll-up shutter detector connected to its related terminal and the built-in inertial piezo sensor. You can properly configure the number of pulses in a time slot and the integration for the roll-up shutter detector and the piezo sensor. The detector is fully configurable via software; only the sensitivity is adjustable on the device itself.

The plastic housing features a design in line with current style trends.

Upon request, the “M” brown version is also available.

Note: the operative range for these devices is evaluated in open field with no obstacles, nevertheless the actual range might be reduced in case the device is installed in indoor locations with peculiar architectural features. For further details, consult the features table.

The autonomy is in the order of years of functioning, according to the features of each device.

LUPUS2K and VOLANS2K are IMQ - Security Systems certified.

2. FEATURES

Model	LUPUS2K	VOLANS2K
Protection class	IP3X	
IMQ certified	EN50131-2-6: grade 2, EN50131-5-3 ⁽¹⁾	
Environmental class	2	
Power supply voltage	3.6 V supplied by 1/2 AA 3.6 V lithium battery mod. ER14250 (supplied as standard eq.)	
Low battery threshold	2.5 V with recovery to 2.9 V.	
Minimum operating voltage	2 V for the transmitter; 2.7 V for the LED indicator.	
Power consumption @ 3.6 V	8 μ A idle, 23 mA max.	10 μ A idle, 23 mA max.
TX frequency	3 channels (configurable via browser): 868.120 MHz, 868.820 MHz, 869.525 MHz for LPD devices.	
Maximum transmitted power	25 mW	
Connection range nominal/maximum	800 / 1900 m in open field; the range is subject to limitations depending on environmental conditions. See note. Note: the ranges refer to 99% reception of the transmitted packets, with the devices in open field at an height of 1,5 m from the ground, respectively without and with the orientation of the antenna in the best direction. The activation of the “tx boost” option, if available, increases the effective range between 10 and 30% but can significantly affect the battery life.	



Model	LUPUS2K	VOLANS2K
Average autonomy	5 years.	4 years.
	Note: for the calculation, 20 total transmissions per day and a supervision transmission every 20 min were considered.	
Zones	Managed as channels. Tamper zone with NC terminals. CH1: On-board magnetic contact. CH2: NC zone for external magnetic contact. CH3: NC zone for roll-up shutter detector. Channels 2 and 3 can be configured via software application (see "10. ELECTRICAL CONNECTIONS").	Managed as channels. Tamper zone with NC terminals. CH1: On-board magnetic contact. CH2: NC zone for external magnetic contact. CH3: NC zone for roll-up shutter detector. CH4: built-in piezo sensor. Channels 2, 3 and 4 can be configured via software application, (see "10. ELECTRICAL CONNECTIONS").
Special operating features and controls		Piezo sensor included in the printed circuit board, with impact sensitivity control and LED indicator for detected pulses. The sensitivity can be adjusted using the on-board trimmer; the integration can be set via software application.
Wiring length with 2 × 0.22 mm ² cable	Roll-up shutter zone: 1 or 8 m, configurable via software application; magnetic contact zone: 20 m max.	
Selections	On-board REED magnetic contact enabling (on one side only).	
LED indications	Blue front LED.	Yellow front LED, used also for piezo sensor pulses visualization.
LED exclusion	Via software application.	
Sound signalling	Built-in buzzer. It can be activated for alarm also in Walk test mode.	
Supervision TX	From 5 to 240 min (default) step between two consecutive supervision transmissions. It can be modified via software application.	
TX encoding	The transmitter is provided with an identification code randomly chosen in test phase among 2 milliard combinations (2 ³¹).	
Transmissions for	Supervision (periodic, with step configurable via software application); tamper events for housing opening; low battery state; alarm/reset for zones with magnetic contact; alarm for roll-up shutter or piezo detector zones.	
Operating temperature	-10 / +55 °C guaranteed by manufacturer - 93 % Rh.	
Dimensions	Transmitter: W 150 × H 33 × D 39 mm; magnet: W 47 × H 18.5 × D 15 mm.	
Weight	75 g (battery and magnet).	79 g (battery and magnet).
Parts supplied	4 self tapping screw 2.9 × 13, 1/2 AA 3.6 V lithium battery mod. ER14250 to be installed in the transmitter, magnet, technical manual.	

⁽¹⁾ grade 1 if supervision time is set as lower than 60 min; grade 2 if supervision time is set as lower than 20 min

LUPUS2K and VOLANS2K are accessories for VIDOMO2K and VICOMPACT2K control units belonging to the Villeggio NG-TRX system, and for other expressly compatible devices.

These transmitters are suitable for indoor installation only. Do not install them in locations where they may be affected by condensation phenomena, for example directly on balconies.



3. MECHANICAL FEATURES

View of the transmitter plastic housing and of the external magnet.

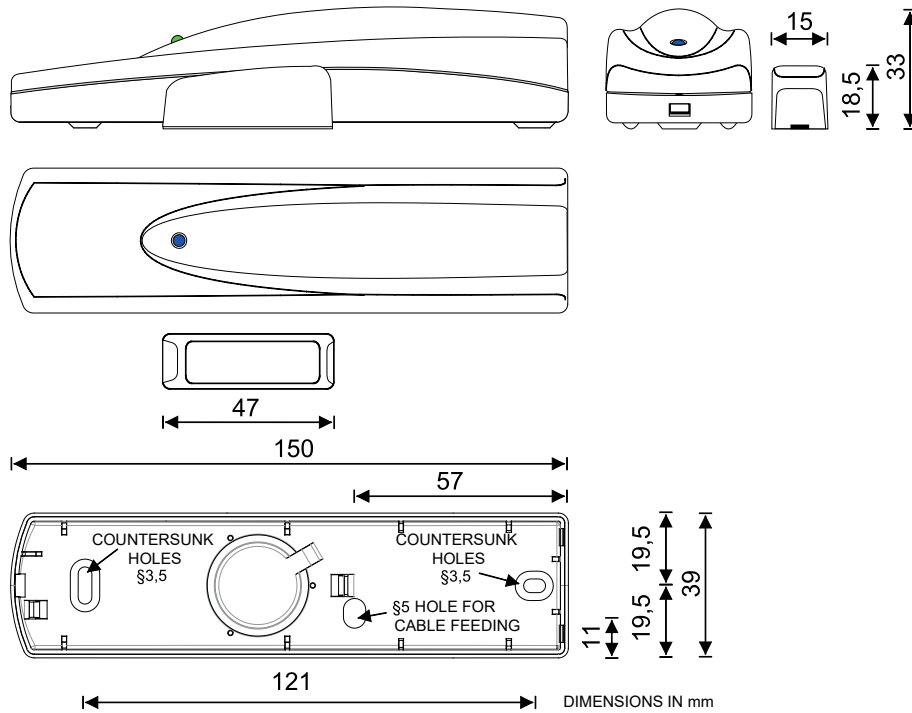

4. HOW TO DISTINGUISH THE DEVICES

The following picture shows the differences between the two transmitters.

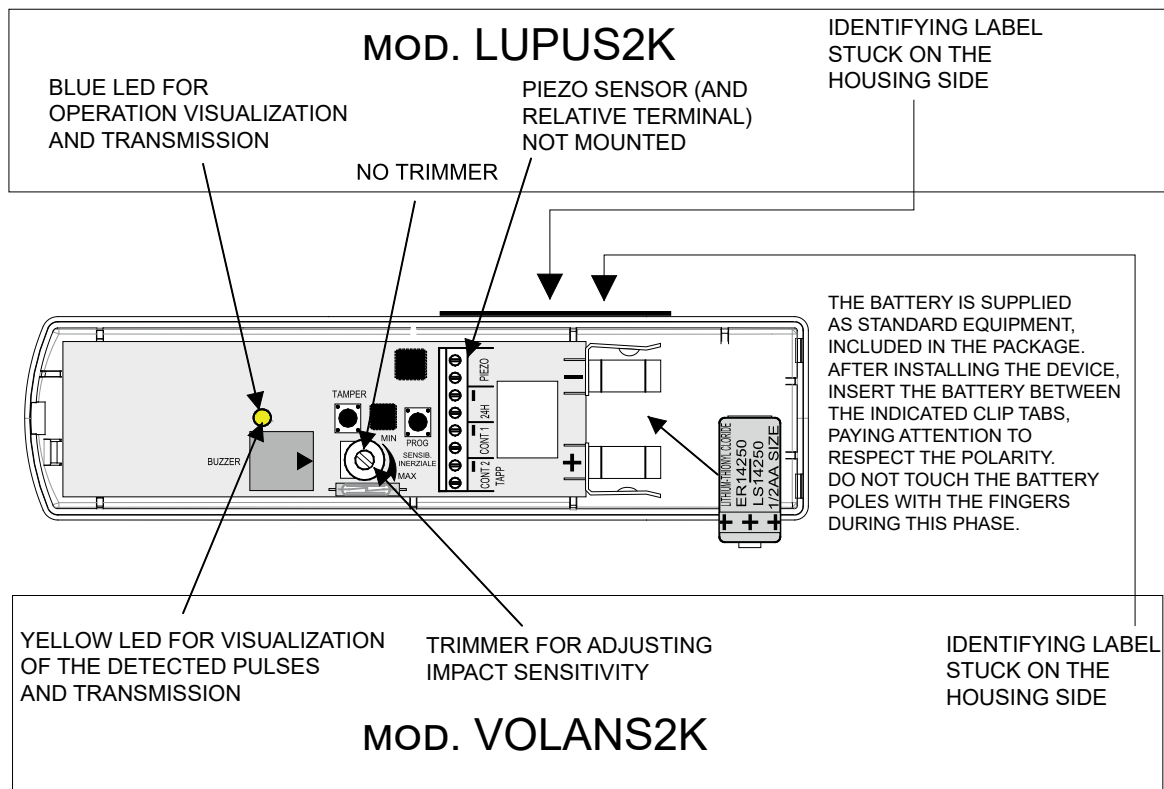



5. HOUSING OPENING AND CLOSING

Perform the following basic operations in order to open and close the transmitter housing.

Opening.

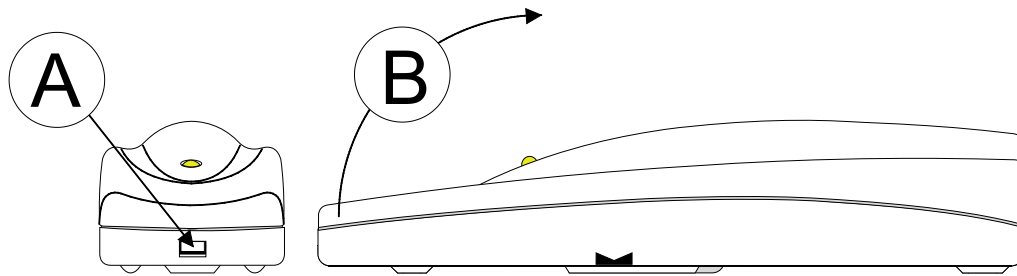

Closing.

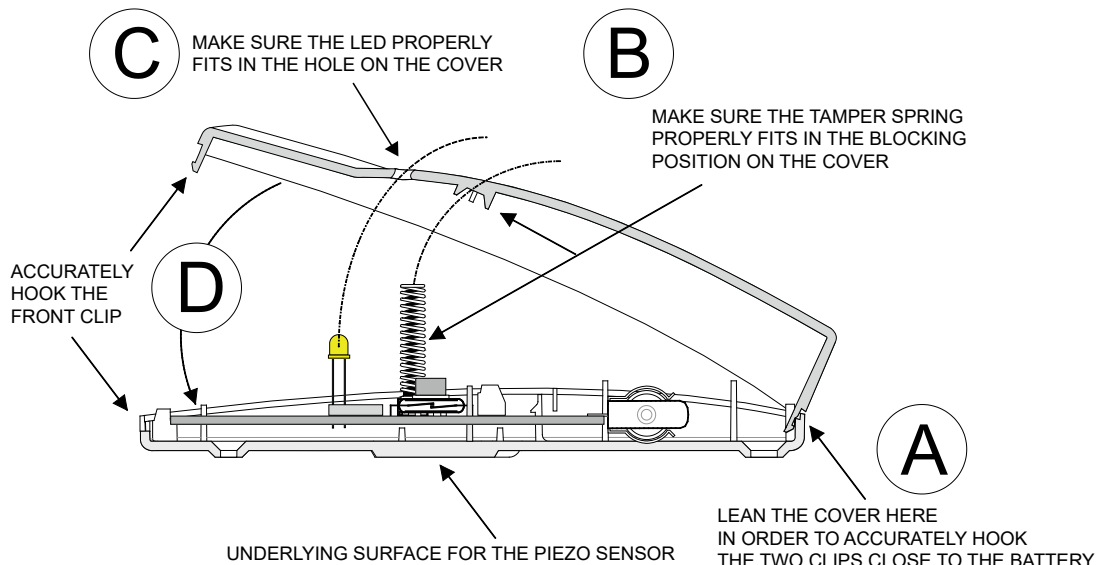

6. FIRST POWER-ON OR BATTERY REPLACEMENT

Particular care is required during first powering. The operations to be performed are listed in the next steps:

1. Insert the 3.6 V battery (supplied as standard equipment) checking the correct polarity.
2. Press and release the Tamper button 3-4 times.
3. Reset any memory of low battery on the control unit or on the compatible receiving device.

WARNING: in case you use a new battery or a battery that has not been used for a long time, a wrong indication of low battery may occur at first activations. Such issue is related to the chemical features of Lithium Thionyl Chloride batteries and it can be solved implementing the above operations.

In case of usage in low temperature locations, we suggest that you keep the battery at room temperature before insertion.



7. INSTALLATION



The installer shall verify that no electrostatic charges are present upon housing opening; internal electronic boards and accessory components may be damaged by such charges.
The same care shall be used during installation, updates and maintenance procedures.

The detector installation must comply with certain rules in order to avoid performance drops due to positioning errors. Indeed, it is very important to define with the utmost care the operating area of the receiving system in which the detector is installed, the actual coverage of the sensors and the correct installation, especially in relation to the nature of the materials used in the building construction.

The following pictures show correct and wrong installation positions, objects that may attenuate RF signals and attenuation in some building materials.

Installing situations:

WRONG !!!

WIRELESS CONTROL UNIT INSTALLED IN DECENTRALIZED POSITION. THE SENSORS TRANSMITTERS POSITIONED AT THE OPPOSITE SIDE OF THE HOUSE MAY BE TOO FAR. THE RADIO SIGNAL MAY BE WEAK BECAUSE OF ARCHITECTURAL OBSTACLES.

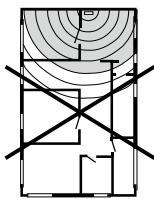

OK

WIRELESS CONTROL UNIT INSTALLED IN CENTRAL POSITION RESPECT TO THE SPACE TO SUPERVISE. THIS POSITION ALLOWS TO REDUCETHE DISTANCE OF PERIPHERAL DEVICES.

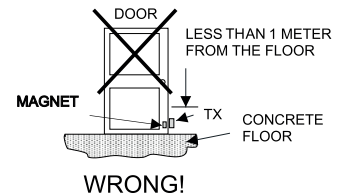
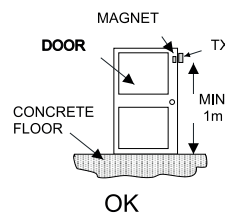
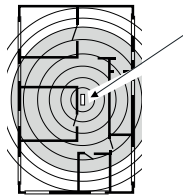

OK

WRONG!

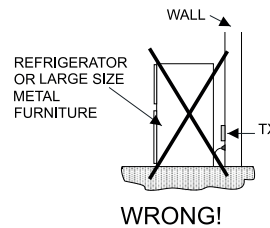

WRONG!

WRONG !!!

DO NOT POSITION THE WIRELESS CONTROL UNIT BELOW GROUND LEVEL. THE RECEIVER AND THE TRANSMITTER SENSITIVITY WILL BE CONSIDERABLY REDUCED.

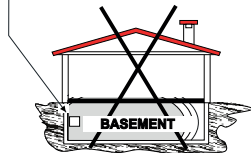

OK

POSITION THE WIRELESS CONTROL UNIT HIGHER THAN GROUND LEVEL. THE RECEIVER AND THE TRANSMITTER SENSITIVITY WILL TEND TOWARDS THE MAXIMUM.

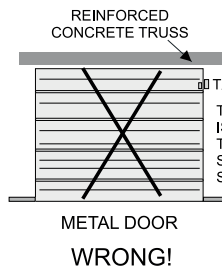
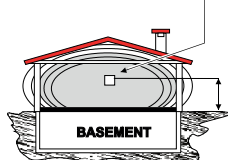

METAL DOOR
WRONG!

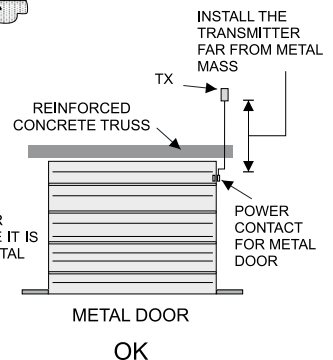

METAL DOOR
OK

Radio signal attenuation in some typical building materials:

90% - 100% OF FULL POWER

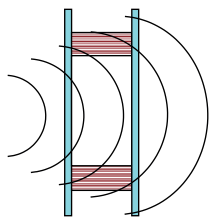

PLYWOOD
PLASTERBOARDS
WALLS

65% - 95% OF FULL POWER

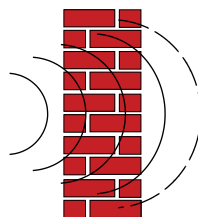

SOLID OR HOLLOW
BRICKS

10% - 70% OF FULL POWER

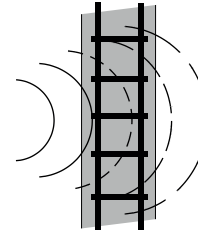

REINFORCED CONCRETE
OR PLASTER AND STEEL
WALLS



Objects that can modify and/or reduce the range (example with a Villeggio NG-TRX control unit):

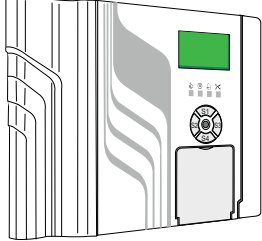

VIDOMO2K OR VICOMPACT2K CONTROL UNIT

THE CONTROL UNIT CAN ALSO MANAGE ACCESSORY DEVICES BELONGING TO STANDARD VILLEGGIO AND HELIOS SERIES

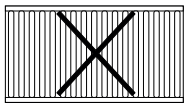

METAL GRIDS AND REINFORCED CONCRETE WALLS

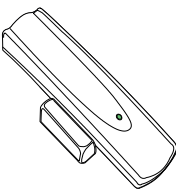

TRANSMITTER WITH BUILT-IN MAGNETIC CONTACT, PIEZO SENSOR AND INPUTS FOR EXTERNAL MAGNETIC CONTACT AND ROLL-UP SHUTTER SENSORS MOD. VOLANS2K

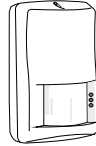

OUTDOOR TRANSMITTER WITH BUILT-IN MAGNETIC CONTACT MOD. VIRGO2K



DT DETECTOR MOD. CONDOR2K

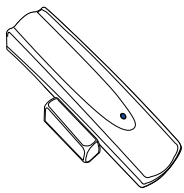

TRANSMITTER WITH BUILT-IN MAGNETIC CONTACT AND INPUTS FOR EXTERNAL MAGNETIC CONTACT AND ROLL-UP SHUTTER SENSORS MOD. LUPUS2K

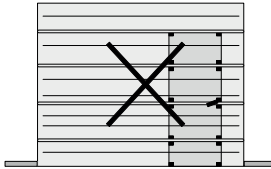

METAL DOORS

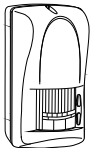

IR DETECTOR MOD. SCORPIO2K



TRANSMITTER WITH BUILT-IN MAGNETIC CONTACT, PIEZO SENSOR AND INPUT FOR EXTERNAL ROLL-UP SHUTTER SENSOR MOD. VOLANSC2K

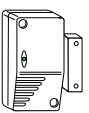

TRANSMITTER WITH BUILT-IN MAGNETIC CONTACT AND INPUT FOR EXTERNAL ROLL-UP SHUTTER SENSOR MOD. LUPUSC2K

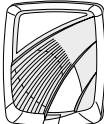

SELF-POWERED WIRELESS SIREN WITH LITHIUM BATTERY PACK MOD. GAIA2K



BIDIRECTIONAL REMOTE CONTROL MOD. ATLANTE2K

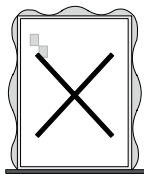

MIRRORS

The device is not suitable for installation on doors/windows that are opened very often (more than 100 activations each day), since this may cause a great amount of radio transmissions and the premature battery fail.

8. COVERAGE AND SENSITIVITY

Before installing the VOLANS2K sensor, carefully consider the maximum sensitivity that can be obtained based on the surface to be protected with its integrated piezo sensor. For this purpose it is useful to refer to the following table:

Surface material	Radius
Brick wall	1 m
Steel	3 m
Wood	3 m
Concrete	30 cm
Plywood	3 m
Glass *	3 m

* The glass test was conducted after sticking the sensor with very adhesive double-sided tape. When installed on glass surfaces, the VOLANS2K transmitter is suitable for detecting impact but not for cuts and perforations.

Installation of VOLANS2K transmitter on a glass panel:

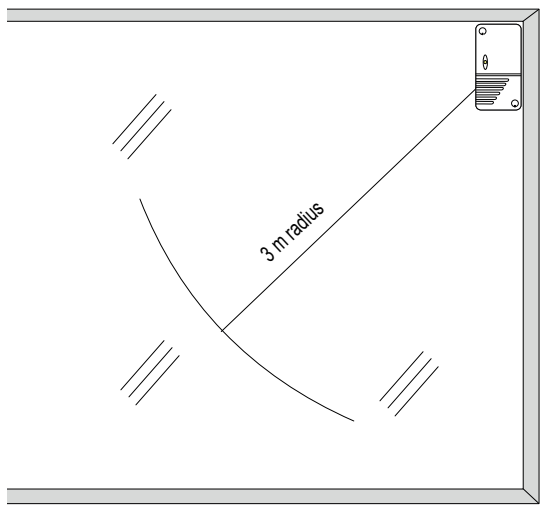



9. MOUNTING

Example of LUPUS2K transmitter mounting inside the housing of a roll-up shutter. One of the possible fixing positions is indicated in the picture on the right.

Search the best position in order to easily replace the battery when needed: a possible position could be the external side of the box.

If you need an additional fixing support, avoid using a metal one in order not to worsen the radio signal.

Note: the maximum distance from the roll-up shutter sensor can be set via software to 1 or 8 meters: this is helpful in case of installation with large windows, or in case you need to install the transmitter far from the window.

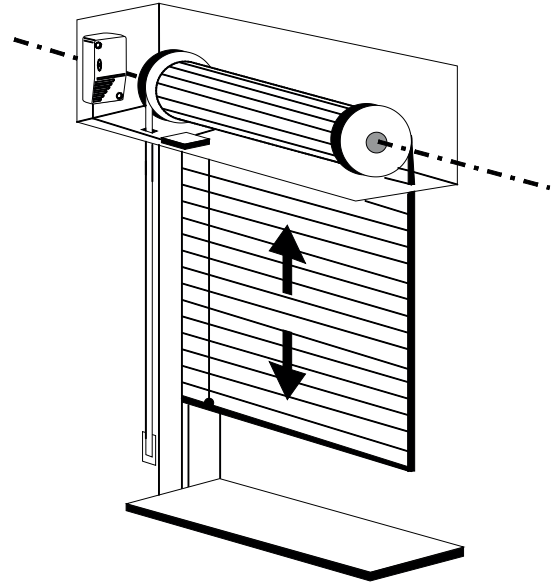

Example of general mounting, **phase 1**.

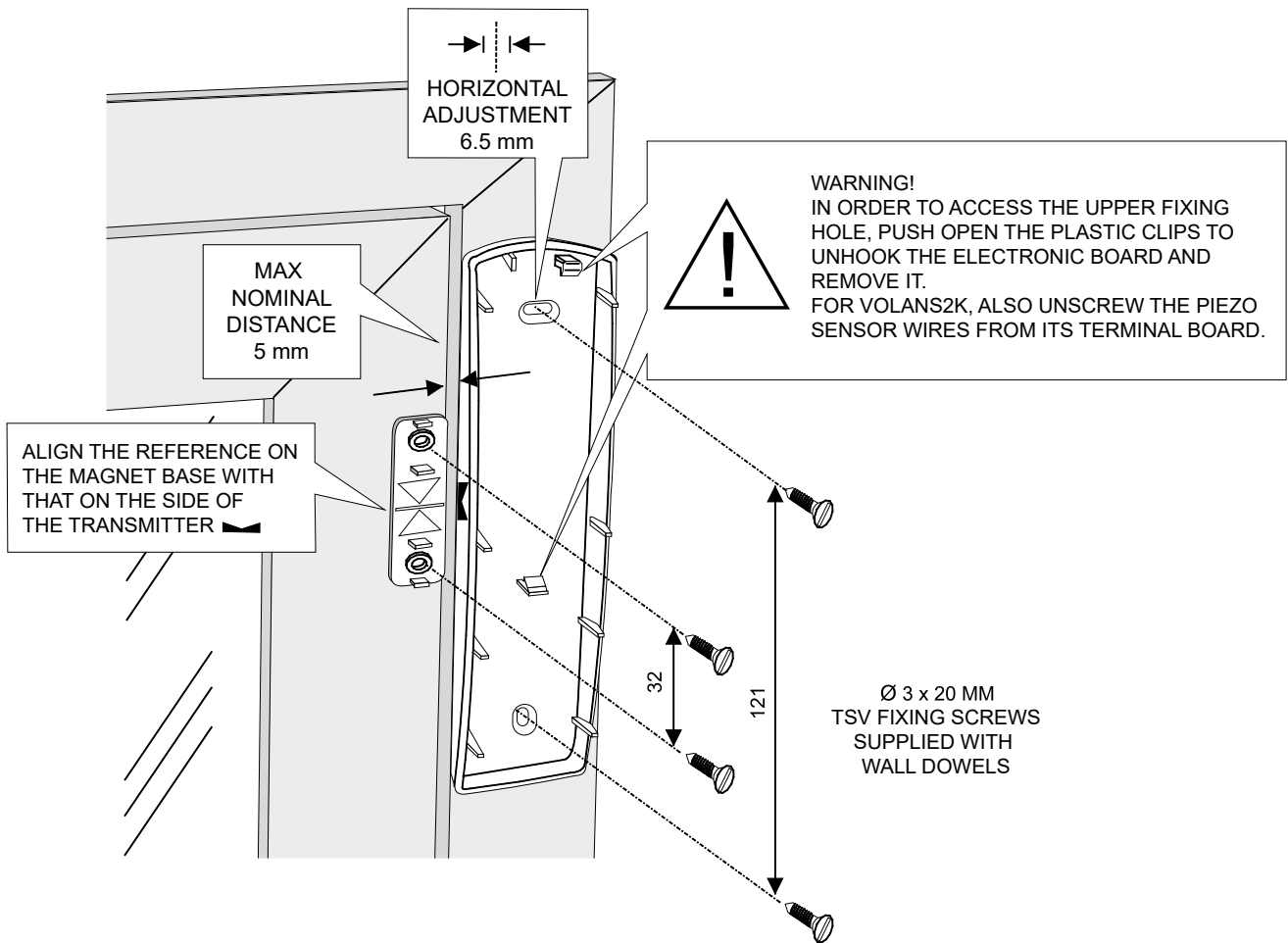



Example of general mounting, **phase 2.**

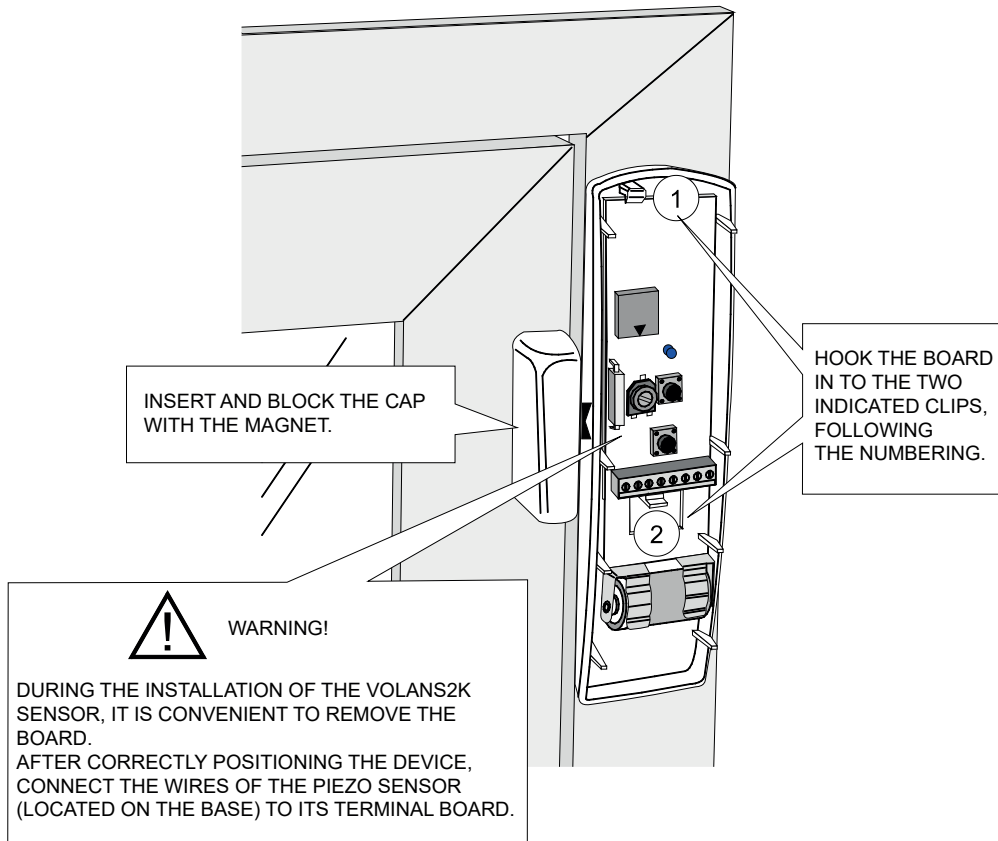

Example of general mounting, **phase 3.**

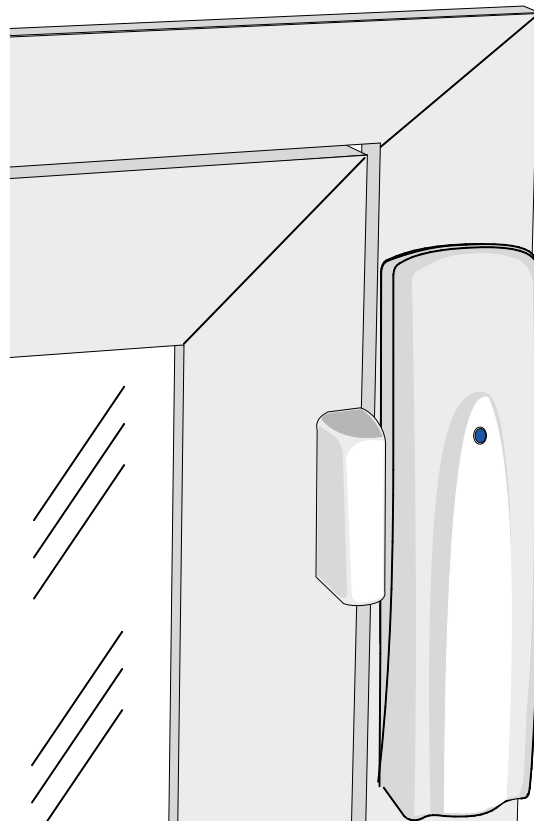



9.1 Protection against removal from mounting surface

Compliance with EN 50131 regulation grade 2 requires that the device is protected against removal from the mounting surface.

Install KSAS1013 kit (green) before fixing the detector base to the fixture.

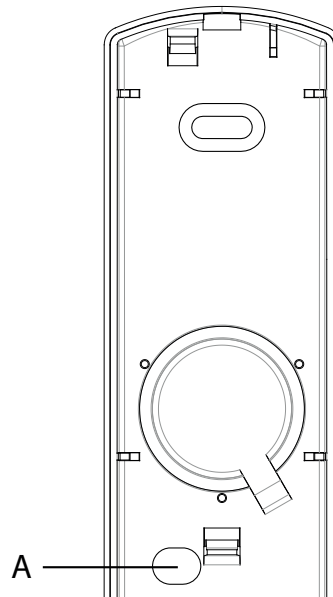

- open pre-drilled area A
- cut the cable connector off
- feed the cable (from the free end) in the drilled hole

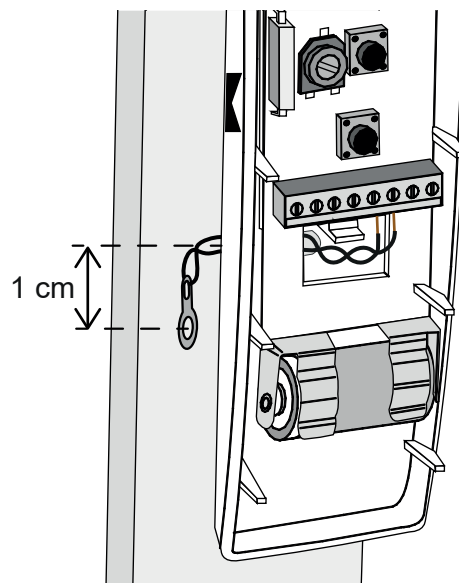

- fix a S4 dowel (supplied) to the wall at a height of 1 cm from the hole
- fix the eyelet to the dowel
- fix the detector base to the fixture
- connect the wires to the 24H terminals on board



10. ELECTRICAL CONNECTIONS

10.1 Board general view

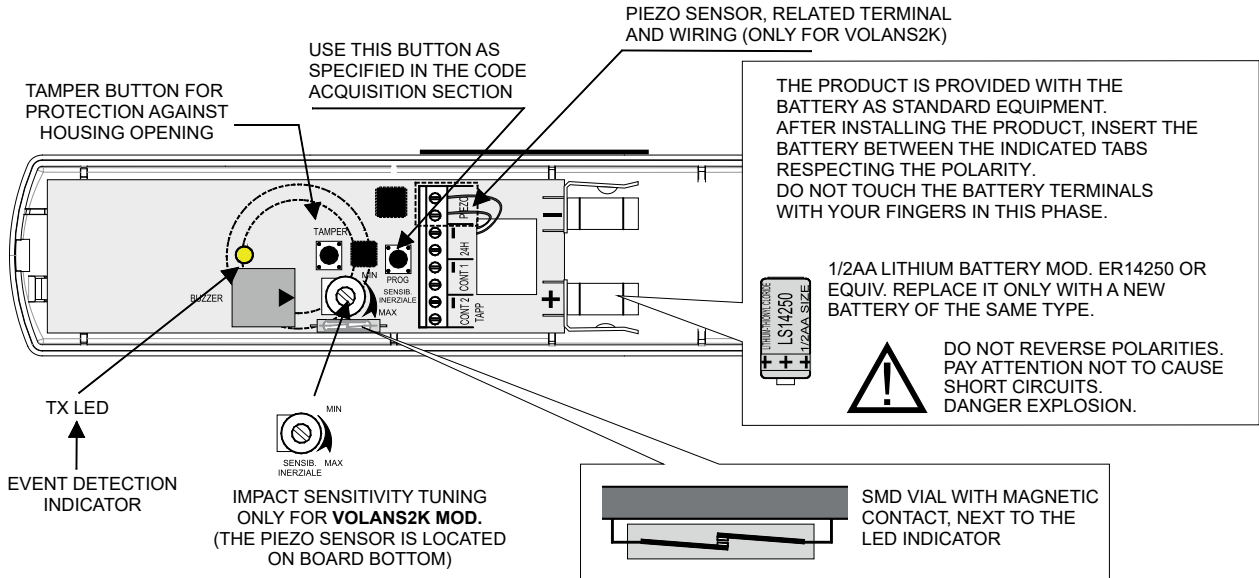

10.2 LUPUS2K general connections

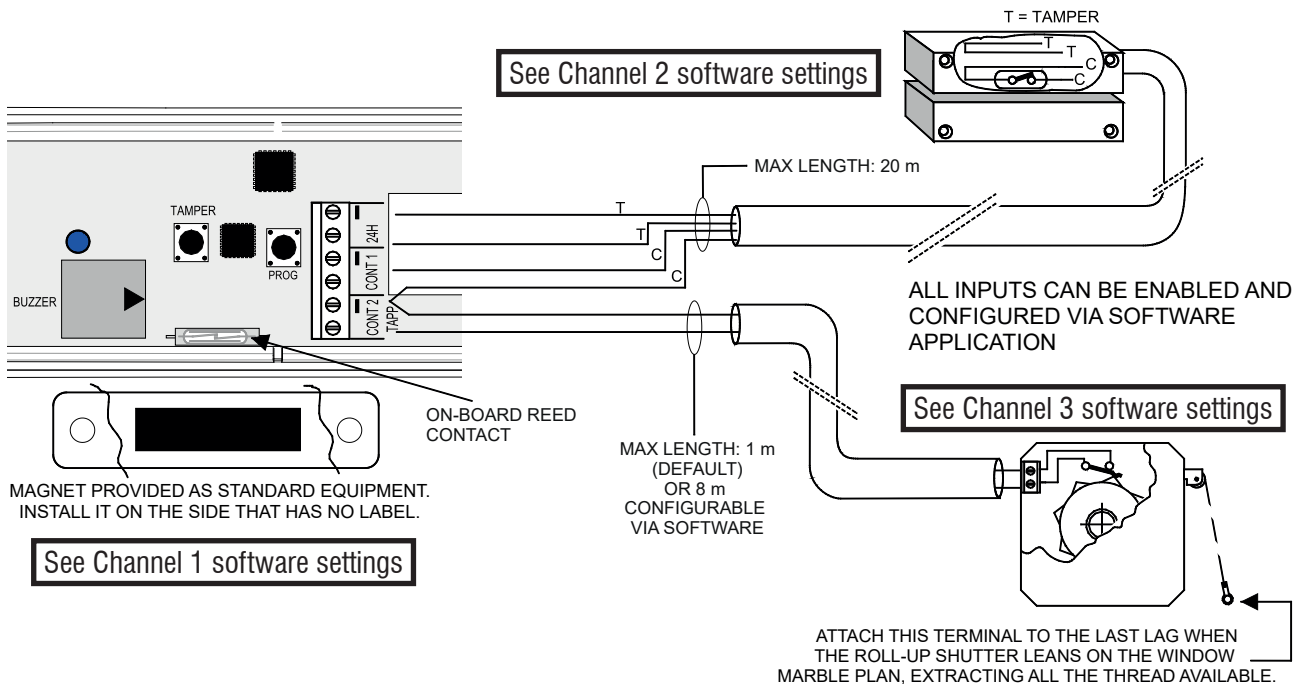

Note: in order to ensure the product certification, it is necessary to connect the Tamper protection lines of the external magnetic contact and of the roll-up sensor to the "24H" terminal.



10.3 Allowed wiring types for LUPUS2K model

Using the software application, you can fully configure wiring types in order to optimize the device operations for the required functions. The following screen is displayed in the “Zones” page, “Radio devices NG-TRX” tab corresponding to the selected zone. For this zone, the specific model and information concerning the type of alarm generated and the firmware version are displayed.

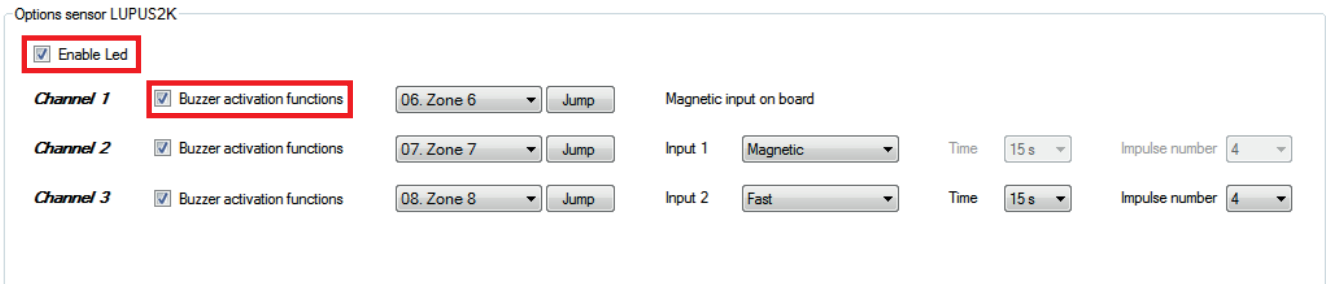

The “**Enable Led**” selection allows you to enable/disable the on-board LED according to the operational necessities. Flag the “**Buzzer activation functions**” checkbox to apply to the specific channel the functional settings concerning the internal buzzer that have been configured in the “**Buzzer activation**” selection displayed in the “**Options NG-TRX**” area. During the detector learning phase, the channels are assigned to three consecutive zones; however, you can immediately avoid memorizing an unused channel or you can disconnect such a channel from the browser application in order to occupy less zones.

The software menu can also be used to move the channels to different zones, e.g. to group all roll-up shutter sensors on consecutive zones. Click on the triangle located at the right of the zone number, and choose a different zone from the list, then click on the “**Jump**” button in order to move the channel (and the zone name) to the selected zone.

In case the zone is already occupied by other devices, the software application will signal the code conflict.

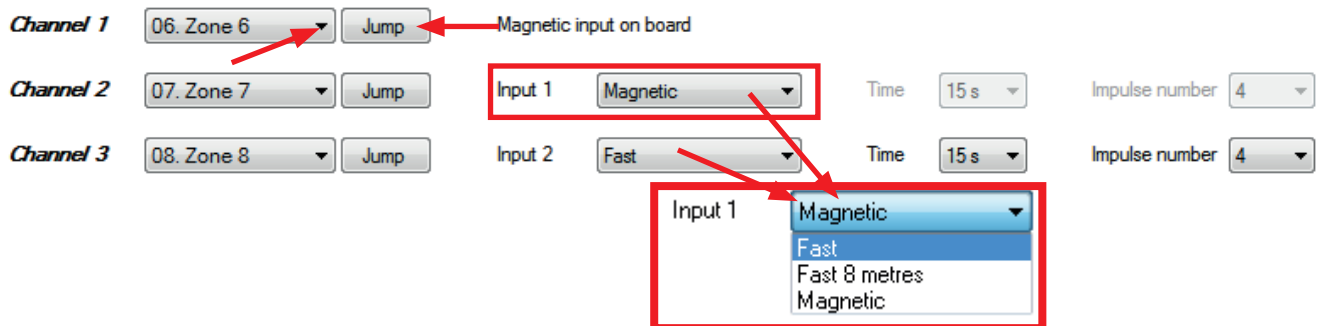

You can configure the type for channels 2 and 3 independently, choosing between magnetic and roll-up shutter type. For the latter, you can define the wiring length (“**Fast**”: 1 m, “**Fast 8 metres**”: 8 m), the number of pulses and the timeout for the detection of a valid alarm.

Timeout (s) = 5, 10, 15 (default) , 20.

Number of pulses = 1, 2, 4 (default), 8.

After configuring the settings, write the configuration to the control unit and then perform the functional test.

Note: use the “**Fast 8 metres**” option only if necessary: it may affect battery life.



10.4 VOLANS2K general connections

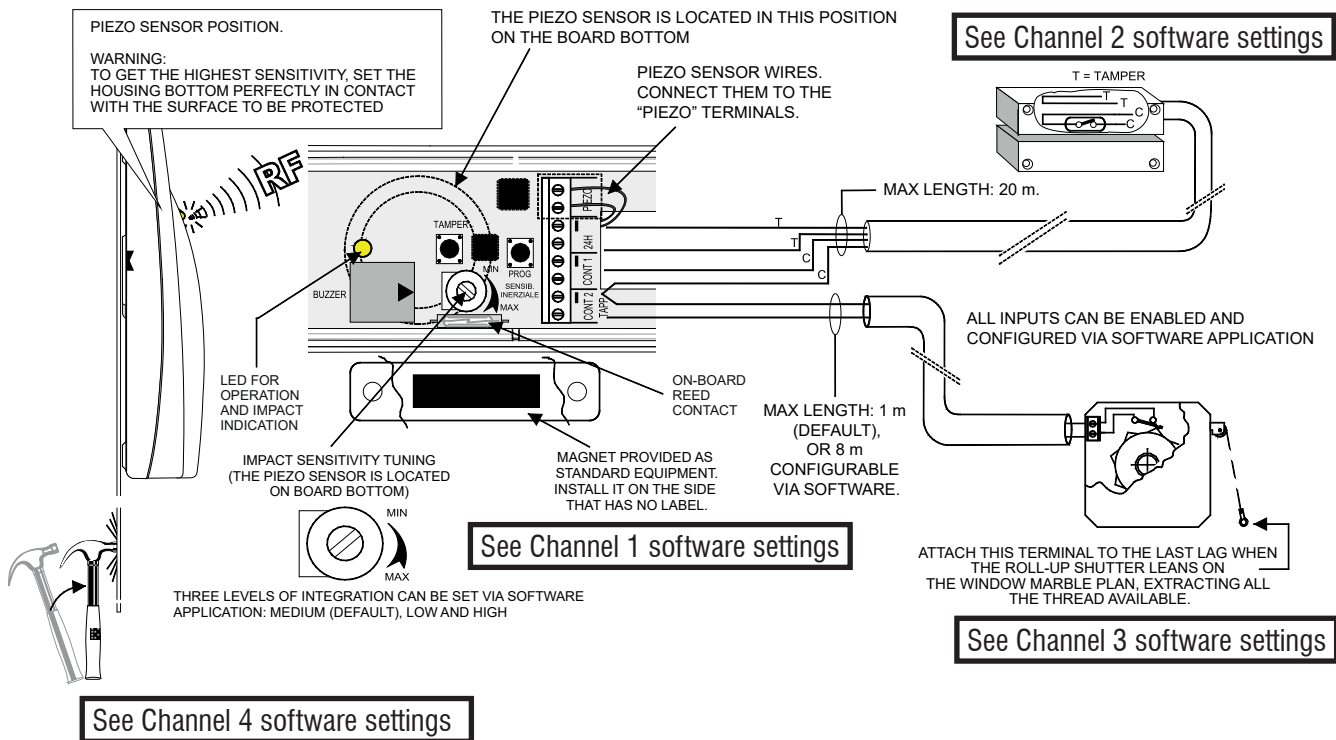

Note: in order to ensure the product certification, it is necessary to connect the Tamper protection lines of the external magnetic contact and of the roll-up sensor to the transmitter "24H" terminal.

10.5 Allowed wiring types for VOLANS2K model

Using the software application, you can fully configure wiring types in order to optimize the device operation in the required functions. The following screen is displayed in the "Radio devices NG-TRX" tab corresponding to the selected zone. For this zone, the specific model and other informations concerning the type of alarm generated and the firmware version are displayed.

Options sensor VOLANS2K

Enable Led

Channel	Buzzer activation functions	Zone	Action	Magnetic input on board	Input	Time	Impulse number
Channel 1	<input checked="" type="checkbox"/>	09. Zone 9	Jump				
Channel 2	<input checked="" type="checkbox"/>	10. Zone 10	Jump	Input 1	Magnetic	15 s	4
Channel 3	<input checked="" type="checkbox"/>	11. Zone 11	Jump	Input 2	Fast	15 s	4
Channel 4	<input checked="" type="checkbox"/>	12. Zone 12	Jump	Integration piezo	Medium		

The "Enable Led" selection allows to enable/disable the on-board LED according to the operational necessities.

The "Walk Test" and "Learning" phase indications will be visualized even when the LED is not enabled.

Checking the "Buzzer activation functions" allows to apply to the specific channel the functional settings of the internal buzzer that have been configured in the "Buzzer activation" selection displayed in the "Options NG-TRX" tab right above this one.

During the detector learning phase, the channels are assigned to four consecutive zones; however, you can immediately avoid memorizing an unused channel or you can disconnect such a channel from the browser application in order to occupy less zones.

The software menu can also be used to move the channels to different zones, e.g. to group all roll-up shutter sensors on consecutive zones. Click on the triangle located at the right of the zone number and choose a different zone from the list, then click on the "Jump" button in order to move the channel (and the zone name) to the selected zone.

In case the zone is already occupied by other devices, the software application will signal the code conflict.

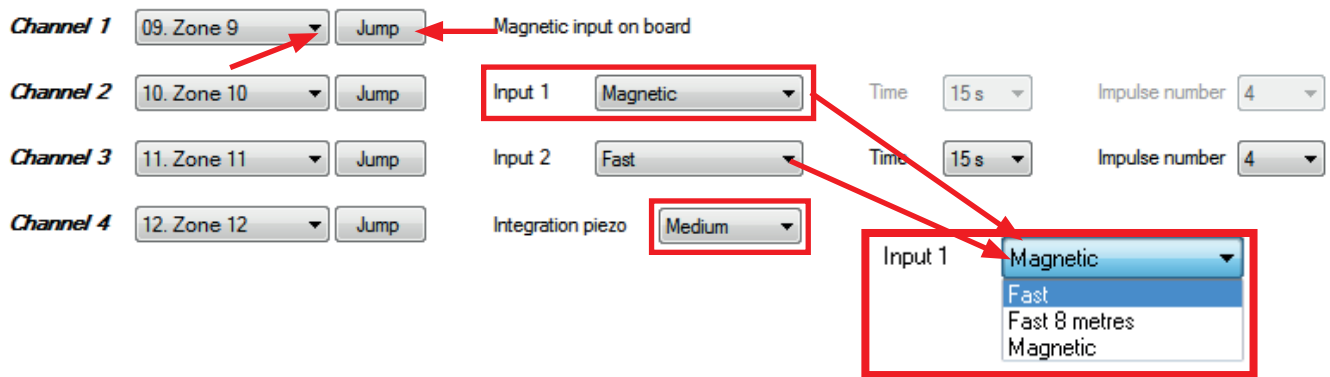

You can configure the type for channels 2 and 3 independently, choosing between magnetic and roll-up shutter type. For the latter, you can define the wiring length (“Fast”: 1 m, “Fast 8 metres”: 8 m), the number of pulses and the timeout for the detection of a valid alarm.

Timeout (s) = 5, 10, 15 (default) , 20.

Number of pulses = 1, 2, 4 (default), 8.

Note: use the “Fast 8 metres” option only if necessary: it may affect battery life.

The built-in inertial sensor response can be adjusted based on the material and the fixing position; the sensitivity can be adjusted using the trimmer indicated in the electrical connection picture; the pulse integration can be set via software application, choosing among 3 levels: Medium (default), Low, High. The picture refers to default settings.

After configuring the settings, write the configuration in the control unit and then perform the functional test.

11. CODE MEMORIZATION

Note: during the code acquisition phases, keep in mind that the control unit identifies LUPUS2K and VOLANS2K as multi-channel devices.

The following procedure allows to memorize the transmitter to a Villeggio NG-TRX control unit.

- Power up the transmitter by inserting the battery. Respect the polarity as indicated in the printed board and in this manual.
 - Enter the programming menu by typing the installer code on a system keypad.
 - Press “OK”, then use the arrow buttons to browse to “**Learn radio det.**”.
 - Press “OK”, then either use the arrow buttons to browse through the available zones or type a zone address.
 - Press “OK”, then press 1 to store the code to the control unit. Press “OK” again.
 - Immediately press the “PROG” button of the transmitter (next to the magnet), and keep it pressed for at least 3 seconds.
 - A double beep of the internal buzzer and a double blink of the transmitter LED signal a successful memorization.
 - The control unit also beeps twice to confirm the successful memorization.
 - The display shows the channels identified by the control unit in this sequence:
CH1 with Alarm/Reset, referring to the built-in magnetic contact,
CH2 with Alarm/Reset, referring to the magnetic contact to be wired,
CH3 with Alarm event, referring to the roll-up shutter detector to be wired,
CH4 with Alarm event, referring to the built-in piezo sensor (**available only for the VOLANS2K model**).
- For each channel, press “OK” for confirmation or # to switch to the next channel, up to the last available channel.
- Note:** during the acquisition phase, you can choose between the acquisition of either all or only some of the channels. After a “partial” acquisition, the channels cannot be added to the control unit manually, but only using BrowserOne.
- If the memorization fails, the internal buzzer plays a long, deep beep. Restart from point 6.
 - Exit the programming menu, pressing “OK” any time you are asked to save/memorize the new settings.
 - Use BrowserOne with the module for your NG-TRX control unit to read the configuration, change the settings for the transmitter, then write the modified configuration. See the next chapter.
 - The new settings will be operative from after the next transmission.
 - Open and close the window or the roll-up shutter (or generate an inertial alarm in case you are using the VOLANS2K detector) to test that the transmitter is working. Since the internal buzzer is usually disabled (unless you activated it via browser in order to ease the test), the only indication is given by the LED turning on.

Note: The device will not be memorized in case of low battery.



12. TRANSMITTER CONFIGURATION VIA SOFTWARE

The transmitter can be fully programmed by using BrowserOne v. 3.4.7 or higher with the module for the control unit v. 8.4.11 or higher. The control unit firmware must be 8.2.0.0 or higher.

See the specific technical documentation for information on other expressly compatible control unit models.

Perform the following operations:

- Start the connection as explained in the programming manual of the control unit.
- Read the current configuration, open the “Zones” page and identify the number of the zone that is assigned the acquired code of the transmitter.

Radio Code on Internal Receiver

Alarm / Reset

Delete Radio Code

LUPUS2K ver. 1.1

NG-TRX

Event type for each channel. The picture highlights the informations concerning the radio NG-TRX system, the firmware version and the transmitter model.

Radio Code on Internal Receiver

Alarm / Reset

Delete Radio Code

VOLANS2K ver. 1.1

NG-TRX

Press to delete the acquired code.

- Still in the Zones page, open the “Radio devices NG-TRX” tab.

Options NG-TRX

Buzzer activation: Buzzer disabled

Performance tuner: Automatic

Supervision interval: Default

Delay supervision anomaly

Tx Boost

Buzzer alarm only

Buzzer alarm and reset

Buzzer disabled

Automatic

Automatic

Minimum consumption

Maximum power

Default

240 minutes

120 minutes

60 minutes

20 minutes

5 minutes

Activates the internal buzzer of the transmitter in alarm or reset for a local operation check of all channels (unless differently set for each single channel). **Default:** disabled (any anomaly is signalled in any case).

You can choose between “Automatic”, “Minimum consumption” to maximize battery life when the signal reception is sufficient, “Maximum power” in case of high limitations due to adverse site conditions (drawback: battery life reduction). **Default:** Automatic.

Set the periodic transmission cadence necessary for the control unit to detect the transmitter control failure, with the consequent reporting and alert actions settable from other software pages. Setting a short interval will affect the battery duration of the device. In the Default condition, the general parameters will be used: they are set in the “System options” page for the NG-TRX devices.

Function available only if you set a precise supervision interval; it allows you to delay the anomaly signal generated by the “supervision failure” signal.

Select to increase the power of the RF section. **WARNING: this causes a decrease in battery duration.** Use only when the range is not sufficient.

On the side of the page concerning the NG-TRX wireless devices, some useful notes are displayed for the correct configuration of the detector, depending on the selection of the “Supervision interval” and the “Tx Boost” function.

NOTE: the selected supervision interval directly affects battery life. More information can be found in the manual of each product.

NOTE: If the interval of supervision is the default, use the general parameters set in the Options page for devices NG-TRX.

NOTE: activation mode Tx Boost may significantly reduce battery life.

These two lines are actually only one, whose content changes.

In the bottom page you can find the specific section for the transmitter channels configuration, described in chapter “10. ELECTRICAL CONNECTIONS”.

Options sensor VOLANS2K

Enable Led

Example

Channel 1 Buzzer activation functions 09. Zone 9 Jump Magnetic input on board

Channel 2 Buzzer activation functions 10. Zone 10 Jump Input 1 Magnetic Time 15 s Impulse number 4

Channel 3 Buzzer activation functions 11. Zone 11 Jump Input 2 Fast Time 15 s Impulse number 4

Channel 4 Buzzer activation functions 12. Zone 12 Jump Integration piezo Medium



Open the “**System options**” page, “**Options NG-TRX**” tab, where the general options of the NG-TRX devices are available. Here you can select the settings that also involve the LUPUS2K and VOLANS2K transmitters.

Receiving multichannel

On

Off

Selection of the multi-channel reception (3 channels), also involving the default/preferential channel selection and the transmission strategy. In case the function is active but communication with the control unit is not possible, the device will use one of the other two remaining channels. For more details see “13.4 Multi-channel reception and strategy”.

The default channel shall be set by the installer, otherwise it is Ch1.

Note: the system uses the preferred channel based on the interference level; if there is no interference, the default channel is used. Each channel change will be recorded in the event log.

Options NG-TRX

Default channel: Channel 1

Supervision interval: 240 minutes

1 Delay supervision anomaly

Enable two-factor authentication for Remote Controls

2 Delay low battery signaling

3 Enable detection RF interference

4 RF Interference as Tamper

Remote range NGTRX

min _____ MAX

Transmissions of NG-TRX command

Common supervision for all system devices, except remote controls; if necessary, it can be modified for each device.

240 minutes

240 minutes

120 minutes

60 minutes

20 minutes

5 minutes

NOTE: the selected supervision interval directly affects battery life. More information can be found in the manual of each product.

The listed options are valid for all NG-TRX devices, except remote controls:

1. **Delay supervision anomaly:** NG-TRX devices generate the supervision failure event 6 supervision cycles later. Example: if the default supervision timer is set to 240 minutes and the delay function is active, the supervision anomaly is generated 24 hours later (240 minutes × 6).
2. **Delay low battery signalling:** if active, the devices run more thorough controls before sending the low battery signal.
3. **Enable detection RF interference:** this selection allows to detect interferences in the three 868 MHz channels and to generate the event log. The interference detection on the preferred channel involves the transition to an other channel if the same interference has already been detected and logged in the last 48 hours. The general options selection about the 434 MHz interference detection does not concern NG-TRX devices.
4. **RF Interference as Tamper:** select this function to use an RF interference event to generate a tampering event, along with the resulting management.



13. OPERATING MODES

13.1 Walk test - System test

The Walk test condition can be activated via keypad, from the SYSTEM TEST » ZONE TEST menu. The beginning of the operating mode is indicated by three beeps of the internal buzzer and by the LED blinking. After exiting the Walk test mode, the internal buzzer will enter operating mode, whose configuration depends on browser programming.

13.2 Operation

In operative conditions, the detector only uses the cover LED, for both alarm or tamper conditions. These conditions can also be indicated by the internal buzzer if it has been programmed for alarm or for alarm and reset. The buzzer is disabled by default.

13.3 Supervision

In case you have made some changes in supervision times (with subsequent memorization in control unit), they will be updated to the set values upon the first transmission. Therefore, if some devices are temporarily not powered, the control unit will signal them considering a different supervision time than the one just set.

After the next power-on of the devices, the supervision time will be updated to the set value. In case of subsequent detector power failure, the system will keep the current supervision time.

In case you change the supervision time after a control unit reset, it will be updated at the first transmission.

Namely, immediately after the main reset, the supervision time that will be considered is the current one; any devices that are not aligned within that time will enter the missed supervision state.

13.4 Multi-channel reception and strategy

It can be set in the NG-TRX Options page.

If the function is ACTIVE (default), the control unit is able to receive on all channels; if it is not active, the control unit receives on one channel at a time. It is possible to increase reliability, when there are interferences on a specific channel, by turning off the multi-channel reception.

Note: We suggest that you disable the Multi-channel reception when you are aware of the existence of radio interference on one or more channels. In this case the control unit will receive only on the default/preferential channel, although the detector performs transmission attempts on all channels.

13.5 Default/preferential channel

Default channel

In case of radio interferences, it is recommended to set the most free channel as the default channel (you can check it through the monitoring functions on the browser and control unit).

In case of strong interferences, it is possible to increase the reliability of the communication by disabling the multi-channel reception.

Preferential channel

The variation of the preferential channel is performed in case of interference detection. The control unit can change the preferential channel independently of the activation of multi-channel reception mode.



14. BATTERY REPLACEMENT AND DISPOSAL

The LUPUS2K and VOLANS2K detectors use a Lithium 3.6 V 1.2 Ah battery mod. ER14250 or LS1425 (1/2AA). Replace this battery only with a new one of the same model. Observe the following insertion instructions:

1. Remove the low battery.
2. Press and release 3-4 times the Tamper button to discharge any charged capacitors.
3. Check the distance of the battery clip tabs. In idle conditions, they have to take an inclination similar to that shown in the figure. The distance between the two tabs should be about 25 mm; if more, you will have to push them inward to obtain the indicated distance.

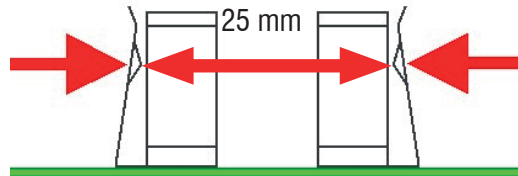

The correct position of the tabs allows an excellent electrical contact and avoids possible and erroneous signalling of low battery.

4. Insert the new battery. Check the polarity.
5. Reset any low battery memories in control unit or in the compatible receiving device.

Dispose of the old battery in full compliance with the current regulations, using the appropriate containers. The materials used are highly polluting and harmful if released to the environment.

15. TABLE OF CONTENTS

1. GENERALS	3
2. FEATURES	3
3. MECHANICAL FEATURES	5
4. HOW TO DISTINGUISH THE DEVICES	5
5. HOUSING OPENING AND CLOSING	6
6. FIRST POWER-ON OR BATTERY REPLACEMENT	6
7. INSTALLATION	7
8. COVERAGE AND SENSITIVITY	8
9. MOUNTING	9
9.1 Protection against removal from mounting surface	11
10. ELECTRICAL CONNECTIONS	12
10.1 Board general view	12
10.2 LUPUS2K general connections	12
10.3 Allowed wiring types for LUPUS2K model	13
10.4 VOLANS2K general connections	14
10.5 Allowed wiring types for VOLANS2K model	14
11. CODE MEMORIZATION	15
12. TRANSMITTER CONFIGURATION VIA SOFTWARE	16
13. OPERATING MODES	18
13.1 Walk test - System test	18
13.2 Operation	18
13.3 Supervision	18
13.4 Multi-channel reception and strategy	18
13.5 Default/preferential channel	18
14. BATTERY REPLACEMENT AND DISPOSAL	19
15. REQUIREMENTS FOR COMPLIANCE TO THE EN50131 STANDARD	19
16. TABLE OF CONTENTS	20